



<b>Publication Year</b>	2018
<b>Acceptance in OA @INAF</b>	2020-11-09T16:45:42Z
<b>Title</b>	PHased Arrays for Reflector Observing Systems and its Upgrade
<b>Authors</b>	Liu, L.; Grainge, K.; NAVARRINI, Alessandro
<b>DOI</b>	10.23919/URSI-AT-RASC.2018.8471542
<b>Handle</b>	<a href="http://hdl.handle.net/20.500.12386/28244">http://hdl.handle.net/20.500.12386/28244</a>



## PHased Arrays for Reflector Observing Systems and its upgrade

Lei Liu<sup>(1)</sup>, Keith Grainge<sup>(1)</sup>, and Alessandro Navarrini<sup>(2)</sup>

(1) The University of Manchester, Manchester, UK, SK11 9DL, e-mail: lei.liu@manchester.ac.uk; keith.grainge@manchester.ac.uk

(2) INAF (National Institute for Astrophysics), Osservatorio Astronomico di Cagliari, Via della Scienza, n°5, Selargius (CA), 09047, Italy, e-mail: navarrin@oa-cagliari.inaf.it

### Abstract

This paper describes the main features of the PHased Arrays for Reflector Observing Systems project, called PHAROS, and of its upgraded version PHAROS2. PHAROS is a cryogenically cooled phased array feed designed for radio astronomy observation across the 4-8 GHz band. The PHAROS project started around the year 2004, thus some of its technology is old with regards to current standards. PHAROS2 will replace most of the key components of PHAROS in order to reduce the system noise temperature, enhance aperture efficiency and digitize the signals from the antenna elements. This paper will focus on the front end description, while the signal down conversion and back end section will be described in more details in a paper titled "Design of PHAROS2 Phased Array feed" [1] which is presented at this conference.

### 1. Introduction

PHased Arrays for Reflector Observing Systems (PHAROS) is a C-band cryogenically cooled low noise phased array feeds (PAFs) system developed as part of a European technology demonstrator project cooperated by JBO (UK), ASTRON (The Netherland), INAF (Italy) and MECSA (Italy). The instrument will be mounted at the focus of the Lovell 76-m diameter telescope at JBO to perform radio astronomical observation through the 4-8 GHz range. The block diagram of PHAROS, shown in Figure 1, was presented in [2, 3]. The instrument includes a RF transparent vacuum window and a 220-element Vivaldi antenna array cooled to 20 K along with 24 low noise amplifiers (LNAs) mounted directly behind the array elements. The LNAs are cascaded with the analogue beam forming system [4] designed to operate at 77 K. The RF signals of the 24 active elements are distributed to four beam formers by passive splitters. Each of the beams results from the combination of 13 RF inputs, while the non-active elements of the array are terminated into 50  $\Omega$  loads. Each beam former consists of 13 individually controllable phase and amplitude control (PAC) units, along with 13 amplifiers to compensate for system losses. The last stage of beam forming is a 16-way Wilkinson

combiner (three inputs terminated). Each analogue beam former is responsible for the individual amplitude and

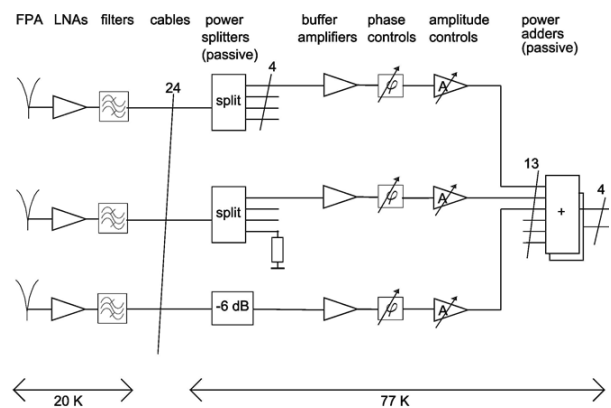

Figure 1. Block diagram of PHAROS front end.

phase weightings of 13 elements in order to produce a single (compound) one-polarization beam.

All the elements of PHAROS were fully tested and integrated. Beam pattern tests were performed in the anechoic chamber at room temperature, while the system noise temperature and gain were tested by hot/cold loads method which was set up both indoor and outdoor. In parallel, electromagnetic simulations are being finalized to find the optimum PHAROS combined-beam properties for an efficient coupling of the instrument with the Lovell telescope. The predictions based on the simulation tools are used for comparison with the beam pattern values measured in the anechoic chamber.

PHAROS2 is an upgraded version of PHAROS and also a technology development program to demonstrate feasibility and competitiveness of high-frequency PAF technology towards SKA Phase2 carried out in the framework of the Phased Array Feed SKA AIP. PHAROS2 will be a cryogenically cooled C-band PAF demonstrator with digital beam former cooperated by JBO, ASTRON, INAF, and Chalmers University of Technology (Sweden) with the following features:

- Low loss vacuum window.
- New design of antenna array without substrate.
- Low loss cryogenic LNAs.

- A digital backend/beam former, and IFoF optical links.

## 2. Key components and upgrade

### 2.1 Vacuum window

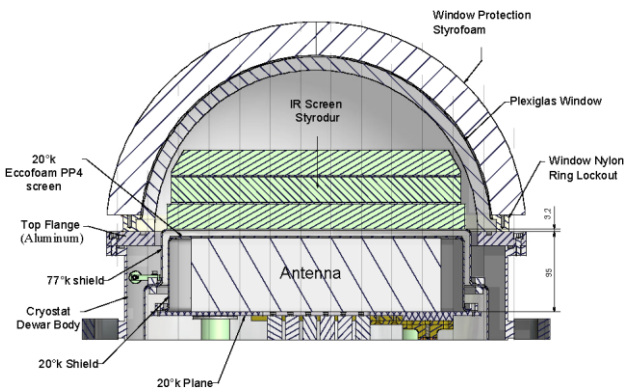

Figure 2. Drawing of vacuum window.

A vacuum window placed on top of the Vivaldi antenna array allows minimum reflection of the incoming RF signals. An Infrared (IR) filter, consisting of a stacked combination of Styrodur and Eccof foam, is located between the vacuum window and the array. A piece of dome-shaped Styrofoam is fixed at the top flange for window protection (shown in Figure 2). The vacuum window consists of 15.6 mm thick Plexiglas that was optimised for maximum transmission at the centre frequency (6 GHz). Hence, towards the low and the high end of C band (4 GHz and 8 GHz), the signal reflection from the vacuum window increases. This is demonstrated by the results of the electromagnetic simulation carried out using the CST software, shown in Figure 3, depicting the electric field transparency at the three frequencies 4 GHz, 6 GHz and 8 GHz.

A new  $\approx 1$  mm thick vacuum window with broadband response will be developed by the National Research Council (NRC,) Canada, as replacement of the existing vacuum window. The new material type under consideration include the TenCate EX-1515 laminate. A prototype of vacuum window based on that material has been fabricated for the NRC cryo-PAF (shown in Figure 4) and another one will be produced and tested for PHAROS2 in the future.

### 2.2 Focal plane array

The current PHAROS antenna array is a dual polarized Vivaldi antenna array consisting of 110 elements for each of the two polarization channels. The separation between elements is 21 mm. The radiating elements are located on opposite sides of a central stripline sandwiched between two Taconic substrates. A 3D drawing of the array is shown in Figure 5. The relatively high insertion loss of the substrate degrades the system noise temperature of the array. A new focal plane array of antennas with improved

beam properties, lower losses and possibly with an extended RF frequency coverage (beyond the current 4-8 GHz band) will be developed by the Chalmers University of Technology. The current plan is to make new design of Vivaldi array but without dielectric and with shortened feeding line for loss reduction.

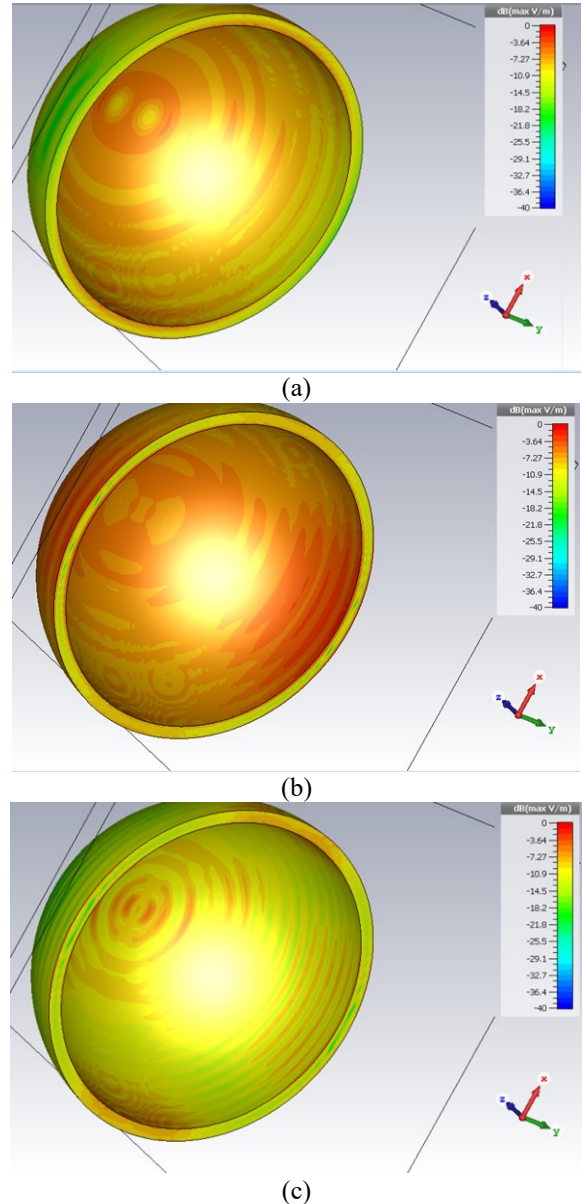
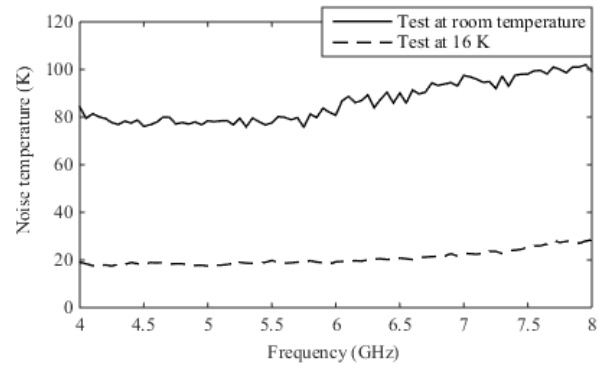

Figure 3. E-field transparency through Plexiglas vacuum window at (a) 4 GHz, (b) 6 GHz, and (c) 8 GHz. The red-coloured parts have a greater transparency (see color-coded vertical scale in the insets).

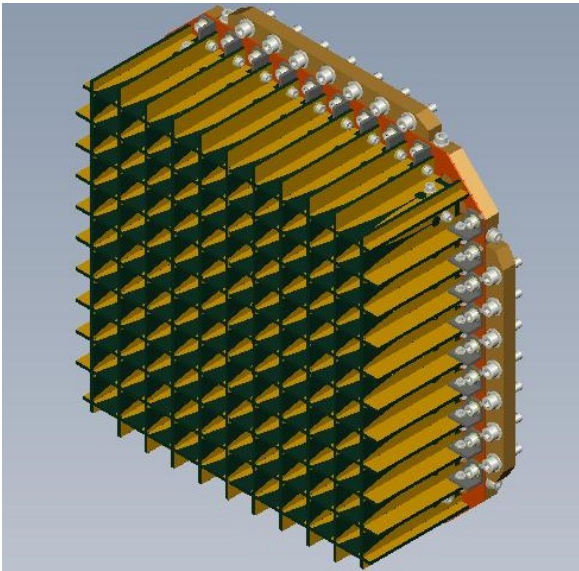

**Figure 4.** 1mm thick vacuum window developed by NRC (image credited by NRC).



(b)

**Figure 6.** LNA used for PHAROS (a) inner view of packaged MMICs, filter and support structure, (b) measured noise temperature at 16 K physical temperature.

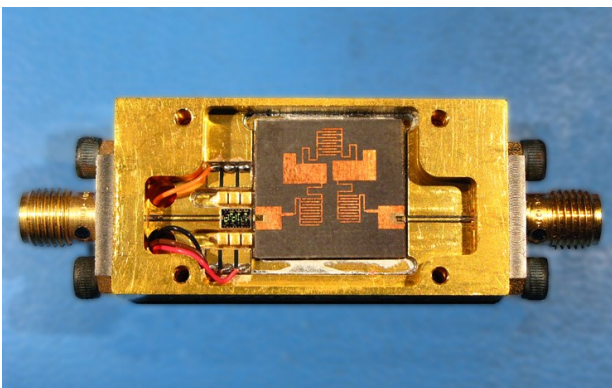

**Figure 5.** 3D drawing of PHAROS Vivaldi antenna array.

### 2.3 Cryogenic LNAs

The LNAs developed for PHAROS (Figure 6), based on MMIC technology, have measured noise performance around 20 K-25 K at 16 K physical temperature.

In order to decrease the system noise, new cryogenic low noise amplifiers with state-of-the-art performance, developed by the company Low Noise Factory (LNF,) will be used. The new LNAs will replace the existing design. Our final goal is to integrate low-power consumption ultra-low-noise LNAs and antennas in a compact module. The mechanical size of the new LNA and the orientation of the RF and of the DC connectors are compatible with the available space. Measured gain and noise temperature in C band are about 40 dB and 2.1 K at 5 K physical temperature. The performance of the new LNAs is indicated at Figure 7. At the  $\approx 16$  K physical temperature at which the LNF LNAs will be used in PHAROS2 the noise temperature performance is expected to slightly increase to a value of order 4-5 K.



(a)



(a)

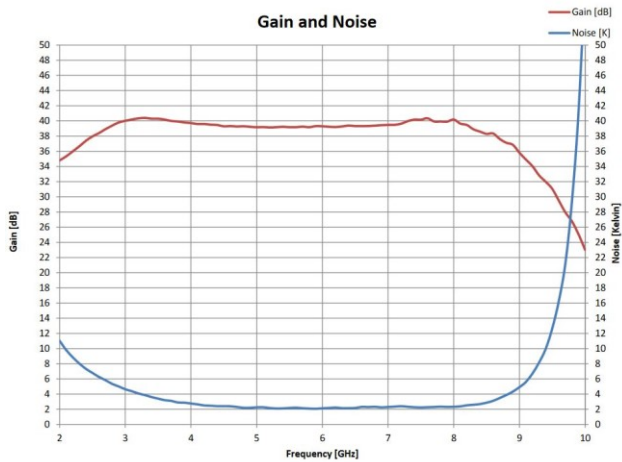

(b)

Figure 7. (a) View of LNF LNA, and (b) gain and noise performance.

## 2.4 Warm section and digital backend

A room temperature (warm) analogue signal processing section is under development for PHAROS2. This includes pre-filtering RF section and room temperature LNAs cascaded with single down-conversion system (converting from RF to IF) and with an IF filtering and signal conditioning section [1]. Such “warm section” employs fully integrated eight-way modules with input coaxial connectors allowing processing all signals from the 24 antenna elements from the PHAROS cryostat with three modules. A digital backend based on iTPM (Italian Tile Processing Modules,) will deliver four beams with is  $\approx 275$  MHz bandwidth each.

## 3. Conclusion and future work.

The key features of the PHAROS phased array feed were presented. The design of a new low loss vacuum window, new antenna array, new LNAs, warm section and digital backend of PHAROS2 were discussed.

## 4. References

1. A. Navarrini, J. Monari, A. Scalambra, A. Melis, R. Concu, G. Naldi, A. Maccaferri, A. Cattani, P. Ortu, J. Roda, F. Perini, G. Comoretto, M. Morsiani, A. Ladu, S. Rusticelli, A. Mattana, P. Marongiu, A. Saba, M. Schiaffino, E. Carretti, F. Schillirò, E. Urru, G. Pupillo, M. Poloni, T. Pisanu, R. Nesti, G. Muntoni, K. Zarb Adami, A. Magro, R. Chiello, L. Liu, K. Grainge, M. Keith, M. Pantaleev, W. van Cappellen, “Design of PHAROS2 Phased Array Feed,” Proceedings of this conference.
2. L. Liu and K. Grainge, "Realization of phased arrays for reflector observing systems," in 2017 XXXIInd General Assembly and Scientific Symposium of the International Union of Radio Science (URSI GASS), Montreal, QC, Canada, 2017, pp. pp. 1-4.

3. L. Liu, K. Grainge, and A. Navarrini, "Analysis of Vivaldi array antenna for phased array feeds application," presented at the IEEE MTT-S International Conference on Numerical Electromagnetic and Multiphysics Modeling and Optimization for RF, Microwave, and Terahertz Applications (NEMO), 2017.

4. J. Simons, M. Ivashina, J. G. b. d. Vaate, and N. Roddis, "Beamformer system model of focal plane arrays in deep dish radio telescopes," in 2005 European Microwave Conference, vol. 3, p. 4, 2005.