



Publication Year	2019
Acceptance in OA @INAF	2023-02-15T16:11:29Z
Title	Support Band 2 development projects to optimize receiver components and vacuum lens INAF Final Report
Authors	VILLA, Fabrizio; CUTTAIA, FRANCESCO; RICCIARDI, SARA
Handle	http://hdl.handle.net/20.500.12386/33501
Number	iALMA-TEC-RER-OAS-001



Science and Technology in Italy
For the upgraded ALMA Observatory
- TECHNOLOGY DEVELOPMENT -

Support Band 2 development projects to optimize receiver components and vacuum lens

INAF Final Report

Document code: iALMA-TEC-RER-OAS-001

Version: A

Status: RELEASED

Date: 09/07/2019

Prepared by		
Name	Organization	Date
Fabrizio Villa	INAF/OAS	09/07/2019
Francesco Cuttaia	INAF/OAS	
Sara Ricciardi	INAF/OAS	
Approved by		
Name	Organization	Date
Fabrizio Villa	INAF/IASF-Bologna	09/07/2019
Francesco Cuttaia	INAF / IASF-Bologna	09/07/2019





1 Change Record

Version	Date	Affected sections	Reason
A	09/07/2019	All	First issue for final review

2 Applicable and reference Documents

AD 1	Collaboration Agreement No. 81231/18/88652/ADI for Support of Band 2 development projects to optimize receiver components and vacuum lens
AD 2	Support Band 2 development projects to optimize receiver components and vacuum Lens; Statement of Work, 2018-04-27
AD 3	Support Band 2 development projects to optimize receiver components and vacuum lens, Minutes of Meeting July 23rd, 2018, FEND-40.02.02.00-0062-A-MIN

RD 1	Support Band 2 development projects to optimize receiver components and vacuum lens. INAF Design Report; iALMA-TEC-DER-OAS-001, 24/09/2018\
RD 2	WCA assembly Procedures, FEND-40.11.02.00-0002-A-PRO
RD 3	Band 2 wideband critical components comparison: Optical efficiencies at room temperature, LNAs and prototype receiver noise performances, FEND-40.02.02.00-0065-A-REP

3 Acronyms

INAF	Istituto Nazionale di Astrofisica
OAS	Osservatorio di Astrofisica e Scienza dello Spazio di Bologna
UdC	Universidad de Chile
UMAN	University of Manchester
LNF	Low Noise Factory
LNA	Low Noise Amplifier



4 Table of content

1	Change Record.....	1
2	Applicable and reference Documents.....	1
3	Acronyms.....	1
4	Table of content	2
5	Introduction and Scope	3
6	Kick off meeting	4
7	Design Review (M1).....	4
7.1	Deliverables at the Design Review.....	4
8	Action Items from Design Review (M1)	5
9	Work Packages Report	6
9.1	WP 1 - WARM CARTRIDGE ASSEMBLY.....	6
9.1.1	WP1.1 WCA layout:	6
9.1.2	WP1.2 WCA characterization:.....	7
9.2	WP 2 - SYSTEM ENGINEERING	7
9.2.1	WP2.1 Optical Truncation design.....	7
9.2.2	WP2.2 System Engineering:	9
9.3	WP 3 - CRYOGENIC TESTS.....	12
9.3.1	WP3.1 Optical truncation measurements:	12
9.3.2	WP3.2 Band 2 full tests:.....	14
9.4	WP 4 - VACUUM LENS OPTIMIZATION.....	16
9.4.1	WP4.1 dielectric material tests:.....	16
10	Final Review Deliverables	19

5 Introduction and Scope

Scope of this document is to report the activity @ INAF in relation to the work of the collaboration agreement No. 81231/18/88652/ADI for Support of Band 2 development projects to optimize receiver components and vacuum lens [AD 1]. Specifically, this release covers all the activities performed in agreement with the Statement of Work [AD2] and serve as a final report for the Final Review scheduled on 15 July 2019.

As reported in the statement of work [AD 2] the activities were organized in Work Packages as follows:

- **WP 1 - WARM CARTRIDGE ASSEMBLY**
 - WP1.1 WCA layout: Design of the WCA structure for Band 2 based on the Band 5 WCA frame, and 2SB receiver delivered by RPG. Provide assembly procedures and perform WCA mechanical integration.
 - WP1.2 WCA characterization: perform noise and stability performance tests with the current Band 2 test system (European band 2 CCA and ALMA test cryostat).
- **WP 2 - SYSTEM ENGINEERING**
 - WP2.1 Optical Truncation design: study and design the modification of the CCA optics support and waveguides to perform cryogenic tests to investigate optical truncation by noise measurements on the Band 2 CCA.
 - WP2.2 System Engineering: provide a system engineering support to the consortium for Band 2 receiver prototype modification to accept 3 different types of optics and 2 types of Low Noise Amplifiers. This will include the control / updates of interfaces and design implementation in the cartridge.
- **WP 3 - CRYOGENIC TESTS**
 - WP3.1 Optical truncation measurements: Perform optical truncation tests by noise measurements at cryogenic temperature on the Band 2 CCA modified based on WP2.1
 - WP3.2 Band 2 full tests: characterization at cryogenic temperature of the Band 2 full prototype (3 configurations with different optics and LNAs, 2 times each)
- **WP 4 - VACUUM LENS OPTIMIZATION**
 - WP4.1 dielectric material tests: Dielectric materials characterization, by radiometric tests, for vacuum window and IR filters, 3 test runs, 6 samples each

The list of deliverables is reported in Table 1 as agreed and reported in the Statement of Work.

Table 1. list of deliverables

	Deliverables	Delivery for Milestone
DS1	3D mechanical model of the WCA layout and mechanical drawings for additional parts if any (ref. WP 1.1)	Design Review (M1)
DS2	WCA assembly procedure document (WP 1.1)	Design Review (M1)
DS3	3D mechanical model of the CCA as modified for optical truncation test and manufacturing drawings for additional parts if any (WP 2.1)	Design Review (M1)
DS4	ICD document based on the different types of optics / LNA configurations (WP2.2)	Final Review (M2)
DS5	Performance Test Reports (WP3.1, WP3.2, WP4.1)	Final Review (M2)

The activities were performed at INAF/OAS (Cryowaves lab) and at INAF/OAA (RF and microwave lab).

The activities here reported are fully inserted in a more general band 2 bridging project in view of production, for which two Band 2 small projects have been approved and managed by ESO:

- ALMA Band 2 Receiver Optimization and Preparation for Production Phase” with the aim to complete the design, perform comparison and finally down-select optical components and LNAs for production.
- “ALMA Receivers Vacuum lens optimization” whose objectives are to investigate alternative to HDPE materials for ALMA vacuum windows and IR filters (focused on B2, but include possible application in other ALMA bands)

6 Kick off meeting

The Kick off meeting of this agreement has been held on July, 23rd 2018. See the minutes of the meeting FEND-40.02.02.00-0062-A-MIN.

7 Design Review (M1)

The first milestone was the Design Review (M1) held on Sept. 26th 2018. The minutes of the review are reported FEND-40.02.02.00-0063-A-MIN. The content of the review was concentrated on the following WPs:

- WP1.1 WCA layout: Design of the WCA structure for Band 2 based on the Band 5 WCA frame, and 2SB receiver delivered by RPG. Provide assembly procedures and perform WCA mechanical integration;
- WP2.1 Optical Truncation design: study and design the modification of the CCA optics support and waveguides to perform cryogenic tests to investigate optical truncation by noise measurements on the Band 2 CCA

The activity related to the period between the Kick off meeting and the Design Review Meeting are traced on the document [RD 1] entitled ‘Support Band 2 development projects to optimize receiver components and vacuum lens - INAF Design Report’.

The review was successfully passed with 6 action items (see FEND-40.02.02.00-0063-A-MIN).

7.1 Deliverables at the Design Review

The following deliverables were agreed for the Design Review (M1):

- DS1: 3D mechanical model of the WCA layout and mechanical drawings for additional parts if any (ref. WP 1.1)
- DS2: WCA assembly procedure document (WP 1.1)
- DS3: 3D mechanical model of the CCA as modified for optical truncation test and manufacturing drawings for additional parts if any (WP 2.1)

The data pack presented at M1 is composed of the following documentation:

iALMA-TEC-DER-OAS-001_A.pdf
AnnexA_B23-WCA-AC-001A.pdf
AnnexB_B23-WCA-CB-001A.pdf
AnnexC_B23-WCA-CB-002A.pdf
AnnexD_B23-WCA-CB-003A.pdf
AnnexH_iALMA-TEC-DWG-OAS-004-A.pdf
AnnexE_iALMA-TEC-DWG-OAS-001-A.pdf
AnnexF_iALMA-TEC-DWG-OAS-002-A.pdf
AnnexG_iALMA-TEC-DWG-OAS-003-A.pdf
AnnexI_B23-WCA-WG-001A.pdf
AnnexJ_B23-WCA-WG-002_DRAFT.pdf
FEND-40.11.02.00-0002-A-PRO.pdf

8 Action Items from Design Review (M1)

The list of actions from Design Review meeting (FEND-40.02.02.00-0063-A-MIN, 27-09-2018) is reported in the following table.

Action #	Content	Actionee	Status
AI#1	ask PMS to provide a quotation from for 1 and for 2 pieces of each; desired delivery: 15 days after that the order is placed.	FVI	Closed See quotation from Pasquali Microwave System: AI1 - E 2692-18 ESO – PAVEL.pdf and AI1 - E 2692-18 Rev.01 ESO - PAVEL.pdf
AI#2	Ask PMS an offer for this part (1 unit); desired delivery: 15 days after that the order is placed.	FVI	Closed See quotation from Pasquali Microwave System: AI2 - E 2692-18 ESO – PAVEL.pdf
AI#3	provide INAF with NAOJ design.	PYA	Closed. The 3D model of the cartridge was implemented by NAOJ.
AI#4a	to provide drawing of the new waveguide.	NAOJ	Closed see AI4a - 0264-A_B2WG_OMT-newLNFamp.pdf

Action #	Content	Actionee	Status
AI#4b	Ask PMS an offer for this part (1 unit); desired delivery: 15 days after that the order is placed.	FVI	Closed. See quotation from Pasquali Microwave System: AI4b - E 2690-18 ESO – PAVEL.pdf
AI#5	to check the number of stages which can be biased simultaneously by the PiXie power supply. To show which changes are needed (SW/HW).	FCU	Closed see AI5 – Closure.pdf And AI5 - AI5 - 376075c.pdf

9 Work Packages Report

Hereafter the activity reports for each WP is reported. For the activities already covered by the Design Review, only a brief summary is reported here. Please refer to INAF Design Report [RD1] for details.

9.1 WP 1 - WARM CARTRIDGE ASSEMBLY

9.1.1 WP1.1 WCA layout:

The activity within this WP has been carried out by INAF-OAS, RPG and ESO. The task of INAF was focused to adapt the downconverter unit developed by RPG into the ALMA WCA layout, in agreement with the CCA/WCA interface requirements and the available hardware for prototype. Moreover, the manufacturing drawings to build new parts have been provided to ESO.

The mechanical structure of the WCA is based on the Band 5 pre-production unit and thus uses standard ALMA design as for other bands (FEND-40.11.00.00-009-A-DWG). Some changes have been implemented to allocate the down conversion unit and the IF stage (see lateral supports in red as shown in Figure 1).

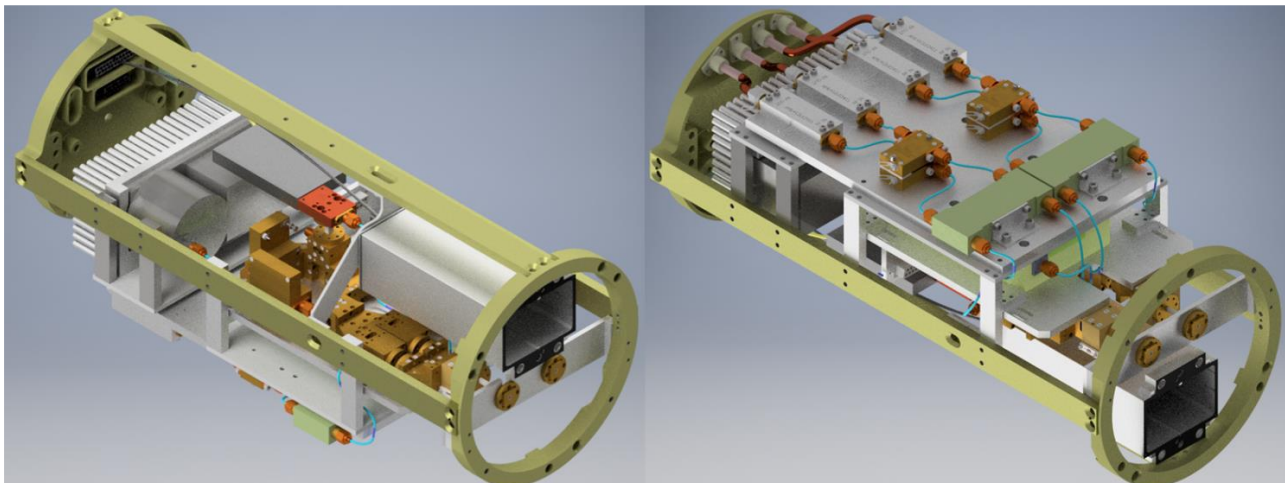

Figure 1. Overall WCA configuration. Boards inside the bias box are not shown for simplicity.

Assembly procedures have been written and reported in [RD2].

9.1.2 WP1.2 WCA characterization:

The characterization of the WCA prototype was performed for the first time during the test campaign run on July 2018, highlighting several functional and performance problems. The tests repeated in November 2018 confirmed the issues, requesting to fix some components of the WCA. Ultimately, after refurbishment from RPG, the WCA was tested again in June 2019, showing good performance in line with the downconverter breadboard.

9.2 WP 2 - SYSTEM ENGINEERING

9.2.1 WP2.1 Optical Truncation design

The CCA design, in the INAF configuration (INAF horn + INAF OMT) was modified to minimize the effects of the optical truncation by shifting the optics by 15 mm towards the lens. This has been obtained thanks to the mechanical reworking of the dummy (Aluminum) support of the horn and to addition of a 15 mm custom made waveguide straight sections on both polarization arms, as shown in Figures Figure 2, Figure 3, Figure 4, and Figure 5:

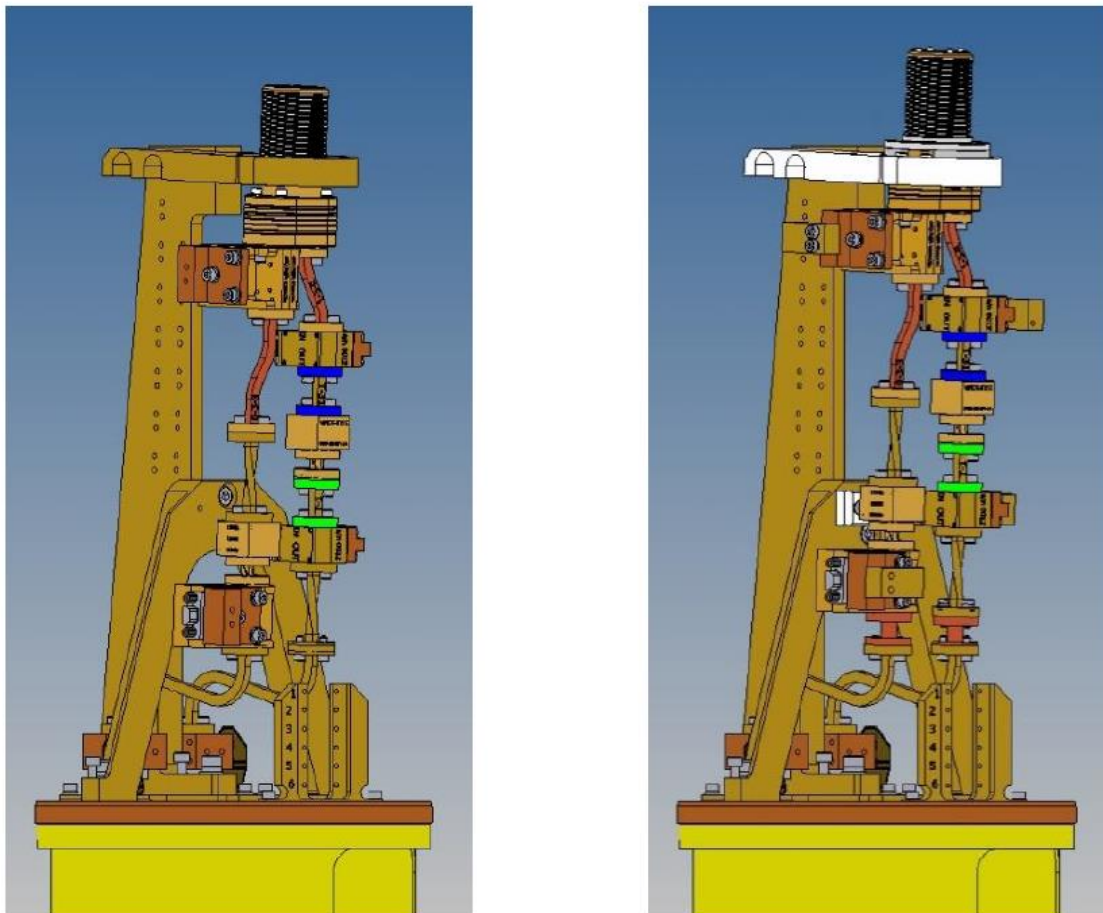

Figure 2. the PDR configuration is represented on the left. At the right the modified configuration with the horn shifted by 15 mm. the horn support (white piece on the right) has been built to accommodate the spacers and the OMT. Note on the right the two waveguide sections in copper to attach the S-shaped common waveguides.

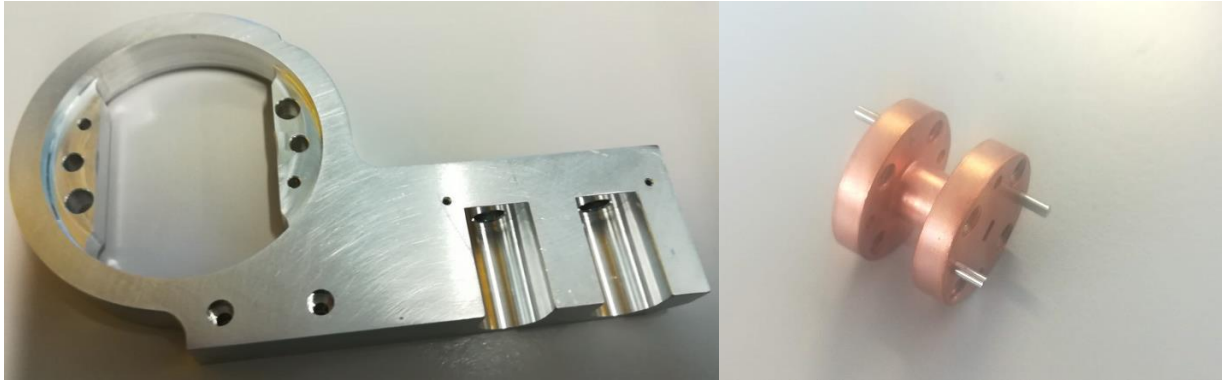

Figure 3. Left: 15K horn support modified for 15mm shimming using the dummy part ALMA-2-01v. Right: straight section of waveguide introduced to shim the cold chain by 15 mm.

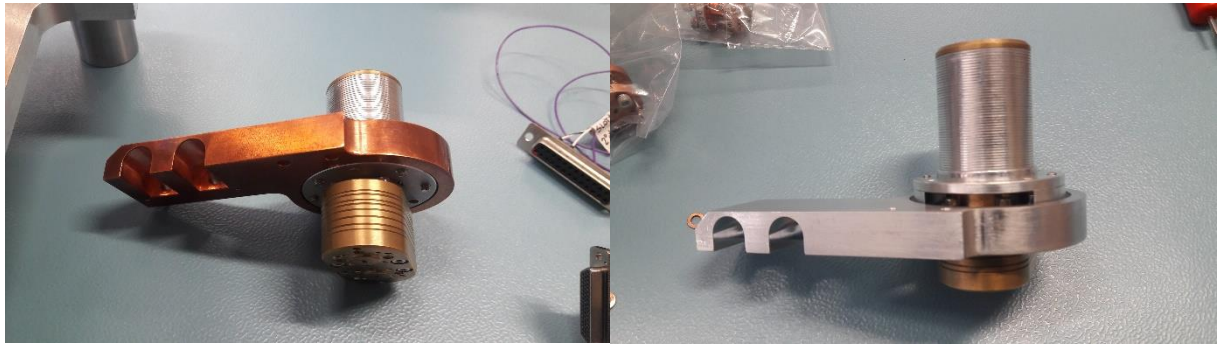

Figure 4. Left: the INAF horn and OMT mounted on the baseline (copper) cryogenic support; right: the INAF horn and OMT mounted on a 15mm shimmed modified (aluminium) cryogenic support.

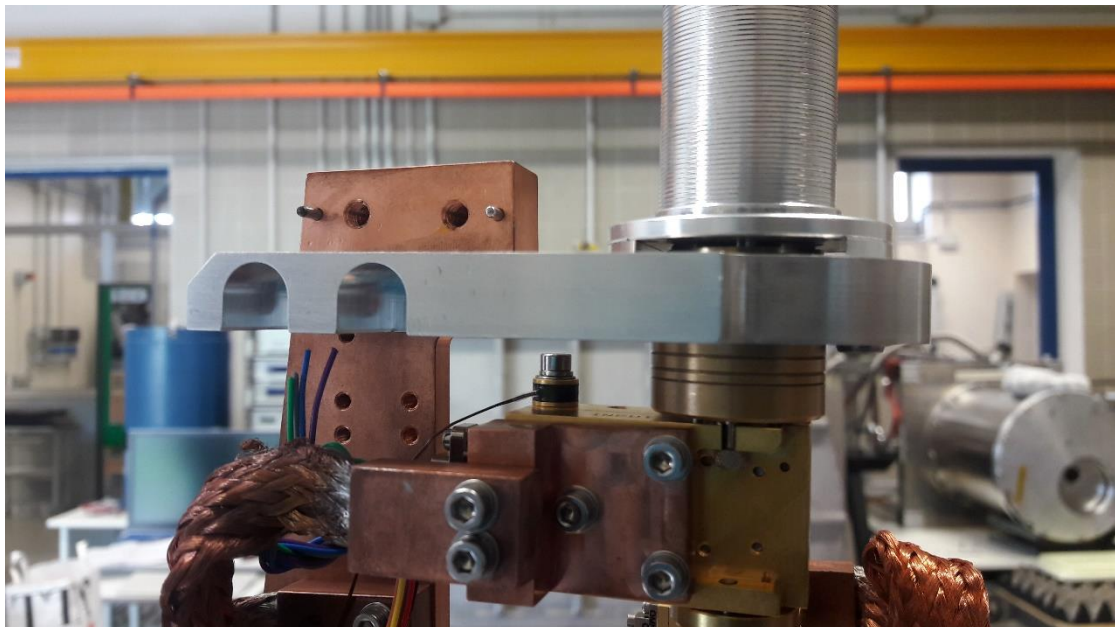

Figure 5. the shimmed configuration as mounted on the CCA (the aluminium support is not fixed yet to the copper vertical support: the gap between the pins (placed in top edge of the copper support) and the aluminium holder was compensated by introducing the two 15 mm straight waveguides.



9.2.2 WP2.2 System Engineering:

System engineering activity was focused to the development of the cartridge configuration to accept the new optics from NAOJ, UdC, and INAF. The following activities were performed:

- Provide PDR cartridge prototype design to NAOJ to modify it in order to accept the NAOJ feed and OMT. The final 3D model of the cartridge implementing this configuration was developed by NAOJ who also took the responsibility to maintain this 3D model.
- To update the design of the cartridge with the new UdC horn and OMT.
- To update the design of the cartridge with the new INAF horn and OMT and
- to provide engineering drawings of the new waveguide sections requested by the changes of OMT output interface.



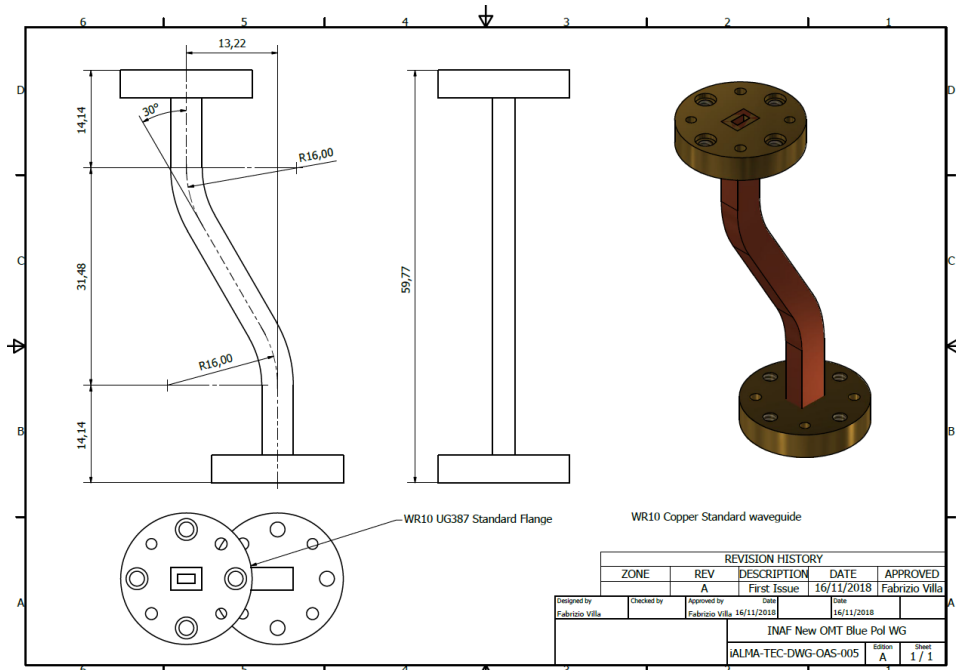

Figure 6. Waveguide section for new INAF OMT, blue polarization. iALMA-TEC-DWG-OAS-005 Revision A

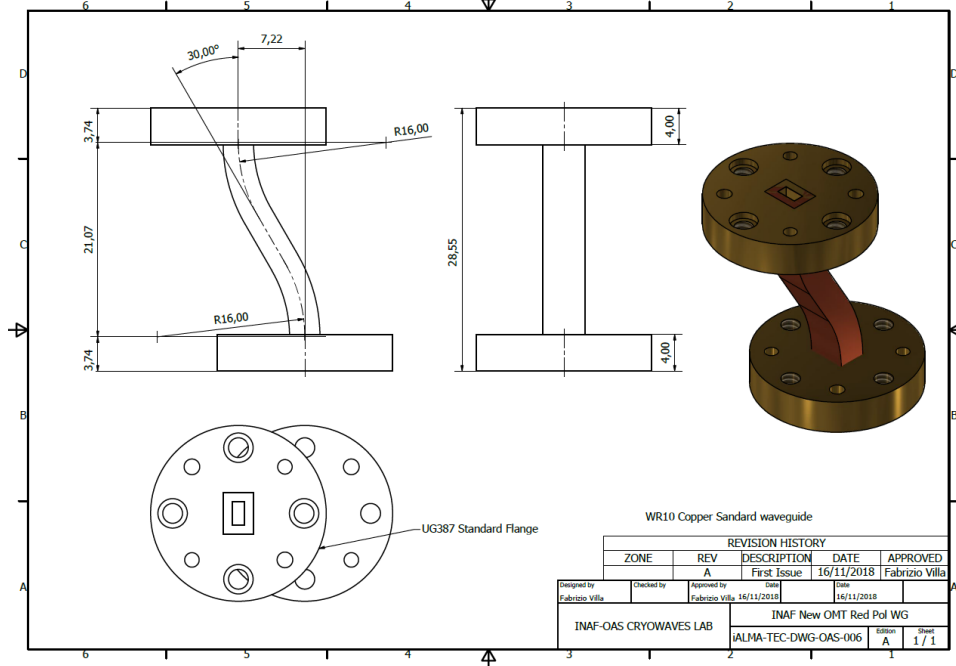

Figure 7. Waveguide section for the new INAF OMT, Red Polarization. iALMA-TEC-DWG-OAS-006 Revision A

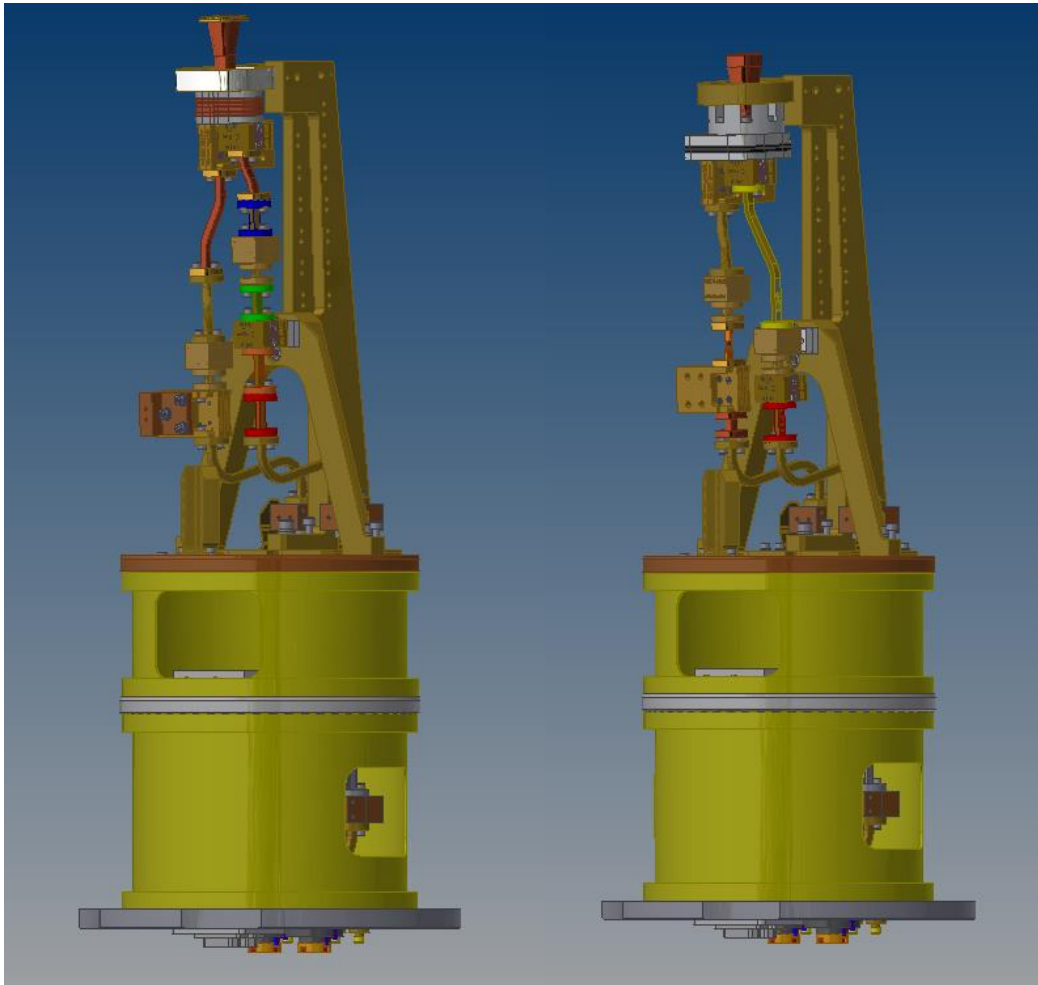

Figure 8. Proposed mounting configuration for new INAF Optics (picture on the left) and for new Udc Optics (picture on the right)

To permit the mounting of the INAF and Udc configurations, the following chain layout has been proposed (see Figure 8):

INAF Configuration		Udc Configuration	
UMAN channel	LNF channel	UMAN channel	LNF Channel
INAF electroformed FEED		Udc Feed (C1)	
INAF CuTe OMT		Udc OMT	
1 st UMAN LNA	1 st LNF LNA	1 st UMAN LNA	1 st LNF LNA
WR10 iALMA-TEC-DWG-OAS-005	WR10 iALMA-TEC-DWG-OAS-005	WR10 0-1-3 section	WR10 1-2-R section
1,5 inch 90° Twist	WR10 T-3 section	RPG isolator	RPG isolator
RPG isolator	RPG isolator	1 inch 90° twist	2 nd LNF LNA
2 nd UMAN LNA	WR10 T-1 section	2 nd UMAN LNA	WR10 T-2 Section
	2 nd LNF LNA	15 mm WR10 section	
	WR10 T-0 section		
	WR10 T-2 section		

9.3 WP 3 - CRYOGENIC TESTS

9.3.1 WP3.1 Optical truncation measurements:

The campaign to test the effects from optical truncation on INAF optics was performed from 02/07/2018 to 07/07/2018 with the support of ESO; the contribution from optical truncation to the system noise was measured by comparing the nominal and the shimmed configurations. The results showed an improved noise of the whole receiver in the shimmed configuration compared with the nominal configuration. Figure 9 and Figure 10 report the comparison of noise performance of the CCA for the two INAF configurations (shimmed and not-shimmed) resulting in an improvement of performances for the shimmed configuration. This was an indicator that the truncation of the beam at the level of the lens add a significant contribution to the overall noise, more evident in the UMAN channel.

Within the same test campaign, the following additional tests and activities were performed:

- First noise measurement with integrated WCA
- UMAN Low Noise Amplifiers bias optimization
- noise at ambient temperature of the following lenses
 - Si lens for UdC
 - HDPE lens for UdC optics
 - HDPE lens for INAF optics
- Noise measurements of filters at room temperature
 - Filter B23
 - Filter B2
- noise excess introduced by the following samples with AR coating (CCA in cryo nominal conditions) :
 - HDPE anti-reflection coating with cylindrical grooves
 - HDPE anti-reflection coating with triangular grooves
 - HDPE anti-reflection coating with concentric grooves
 - UHMWPE anti-reflection coating with concentric grooves

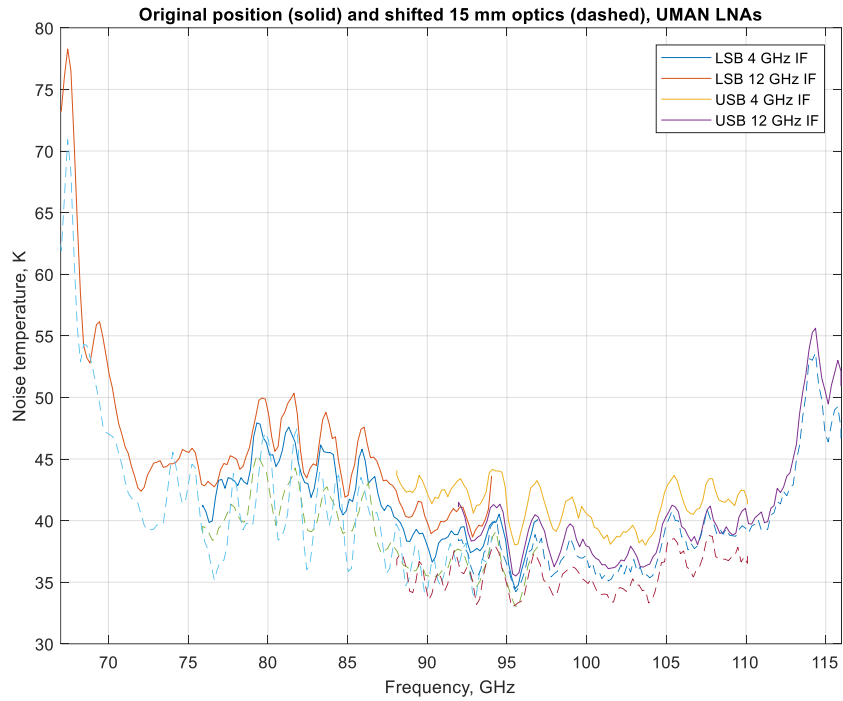

Figure 9. Noise (Kelvin) as function of frequency for the cartridge prototype UMAN channel, with INAF Optics shifted by 15 mm towards the lens.

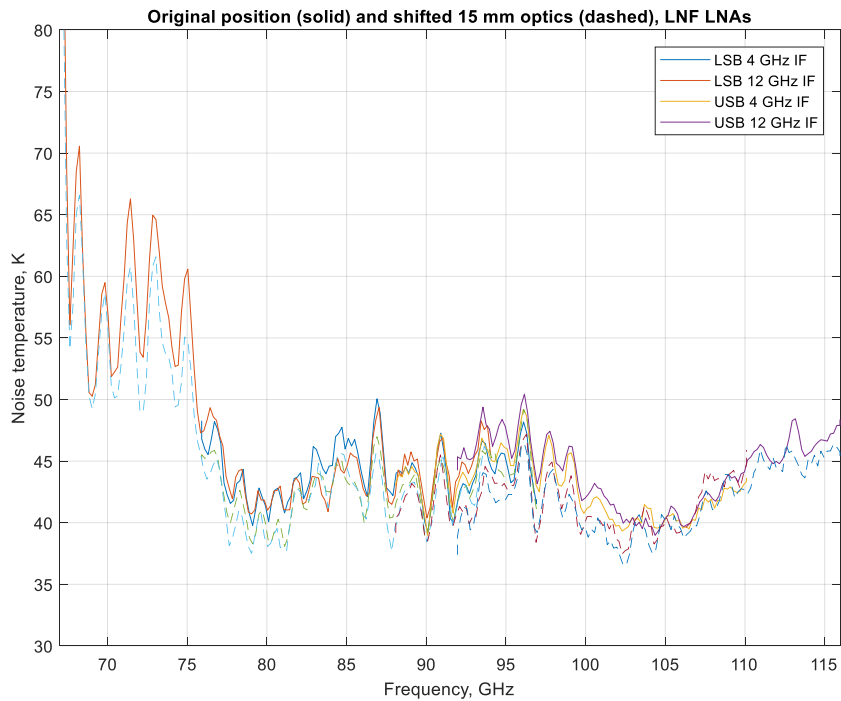

Figure 10. Noise (Kelvin) as function of frequency for the cartridge prototype LNF channel, with INAF Optics shifted by 15 mm towards the lens.

9.3.2 WP3.2 Band 2 full tests:

limited to this WP, four test campaigns in total were performed at Cryowaves INAF/OAS laboratory with the support of ESO. One on 2018 and three on 2019. The summary of the activities is reported in Table 2

Table 2. Summary of activities performed during cryogenic test campaigns in 2018/2019

From 13/11/2018 to 23/11/2018	Test campaign focused on noise measurements of CCA with NAOJ optics
<ul style="list-style-type: none"> • test with CCA and WCA with the objective to optimize the WCA performances • Stability and test of bias module with oscilloscope • Noise performance measurements with PDR INAF configuration • Implementation of the ESD board • Noise performance measurements with NAOJ configuration • Noise performance measurements with NAOJ configuration and downconverter • bias UMAN Low Noise Amplifiers optimization • Stability measurements on LNF e UMAN amplifiers • Noise measurements with WCA stand alone and LN2 load • Noise measurements on grooved materials samples with different thickness: <ul style="list-style-type: none"> ○ 3mm + grooves ○ 19mm + grooves ○ 19mm + grooves 	
From 07/02/2019 To 22/02/2019	Test campaign focused on the noise characterization of the CCA with INAF new optics and UdC new optics
<ul style="list-style-type: none"> • test CCA + DOWNCONVERTER • setup of NAOJ configuration and Si Lens • Test with light on / off on Si lens to compare noise in presence of light / dark conditions • Three new flat material samples tested with noise measurements. • Optimization of bias for LNF amplifiers • Noise performance measurements with new optic's INAF configuration • Noise performance measurements with new optic's UdC configuration • Noise performance measurements with NAOJ configuration for comparison with first NAOJ measurements • Optimization of bias for LNF amplifiers • Susceptibility test of Si lens to external light with a 150W light @ 2m and @ 1m 	
From 11/03/2019 To 15/03/2019	Test campaign focused on the characterization of UHMWPE lens procured by NAOJ
<ul style="list-style-type: none"> • Noise measurements with NAOJ optics and downconverter and the following lenses: <ul style="list-style-type: none"> ○ Si Lens procured by Munich ○ HPDE lens procured by UdC ○ UHMWPE lens procured by NAOJ 	

From 17/06/2019 To 21/06/2019	Test campaign focused on the characterization of new Si sample with AR coating procured by ESO and on the performance verification of the complete receiver (WCA fixed by RPG + CCA with amplifiers fixed by LNF)
<ul style="list-style-type: none">• Performance noise measurements of the CCA with NAOJ optics, UHMWPE lens and downconverter: results are in line with those from the March 2019 campaign (UMAN channel).• Noise measurements with Si flat sample with AR coating.• Noise measurements with UHMWPE 27 mm flat sample with AR coating• Electrical debug of the WCA• Performance noise measurements of the CCA with NAOJ optics and WCA: results are in line with those obtained using the downconverter as warm receiver.• Stability measurement of the complete receiver (CCA + WCA).	

in this report there is no intention to present extensive results and conclusions because it is out of the scope of this agreement as they are under ESO management.

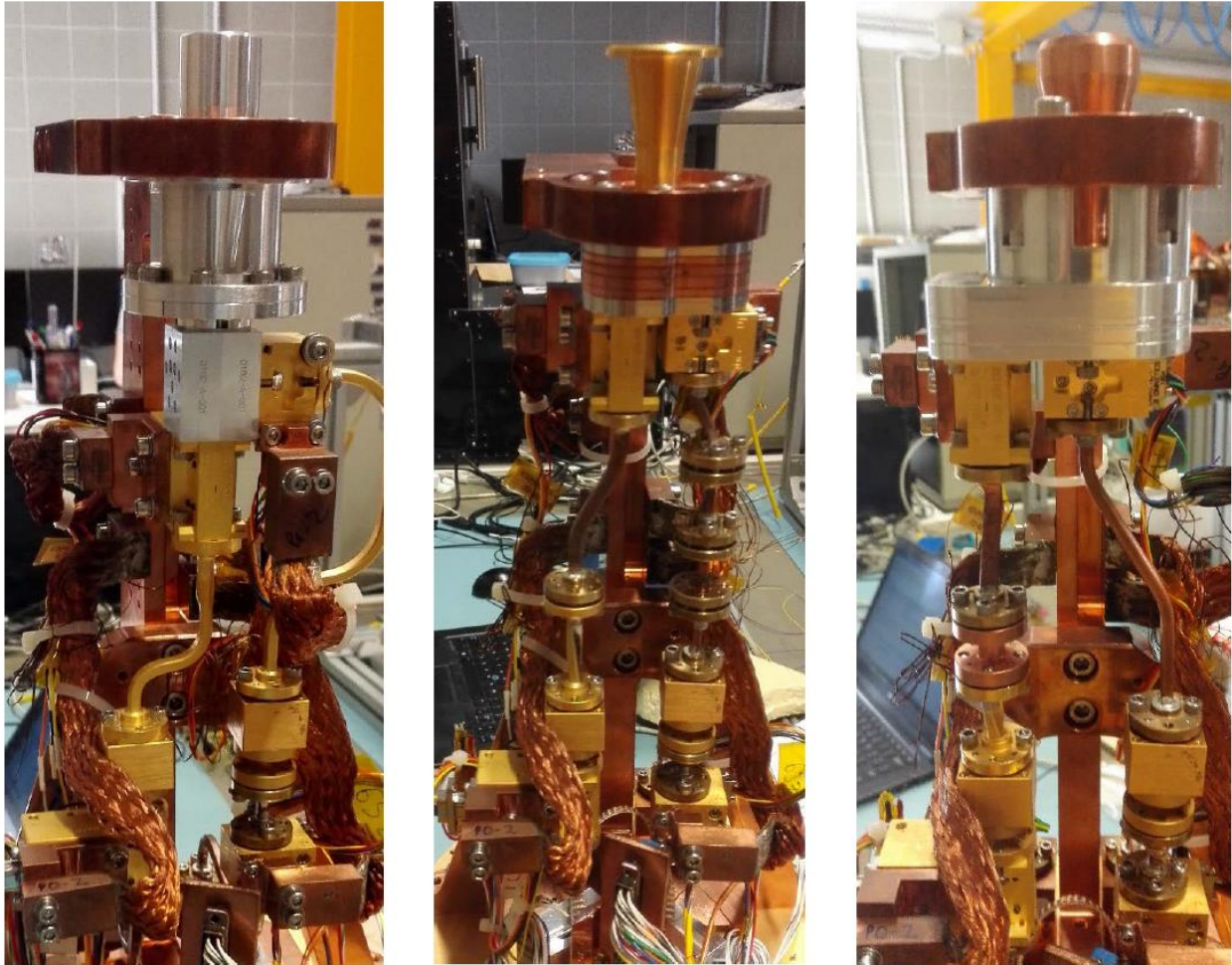

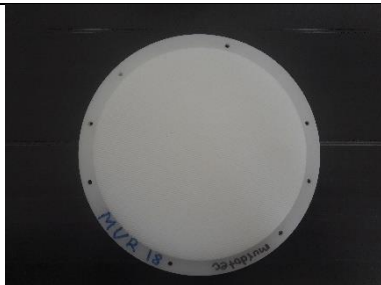



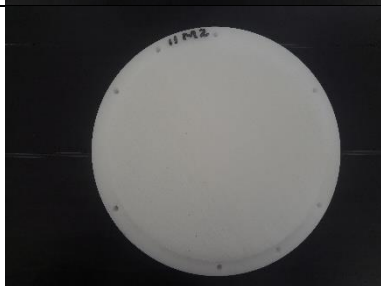



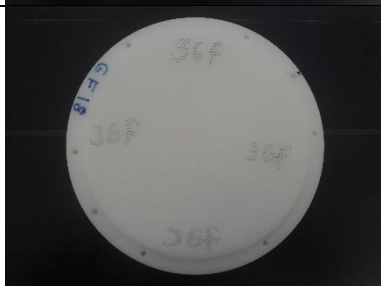

Figure 11. left picture shows the cartridge with the NAOJ optics installed, while the picture at centre shows the new INAF optics mounted. At the right the cartridge has been integrated with the UdC optics configuration.







9.4 WP 4 - VACUUM LENS OPTIMIZATION

9.4.1 WP4.1 dielectric material tests:

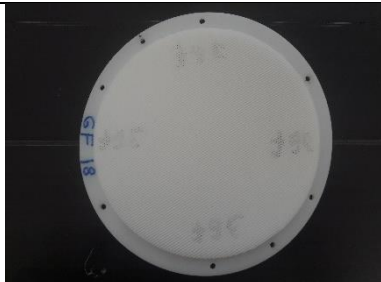
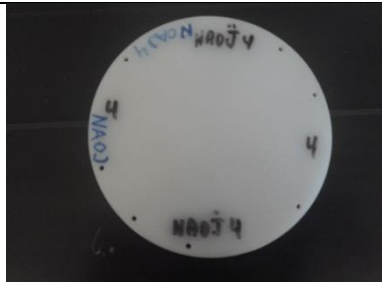
Characterization of several materials and Anti-reflection coating was performed in combination with the noise characterization of the CCA (in combination with the downconverter) and of the complete receiver (CCA + WCA) . Table 2 reports the name imprinted on each sample and the associated picture. The definition, composition, manufacturing and performance of each sample is under ESO responsibility and out of the scope of this agreement. The description that follows is based only on the list of the samples tested at INAF.

Table 3. list and picture of dielectric samples as tested at INAF

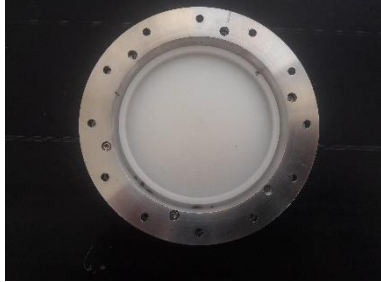
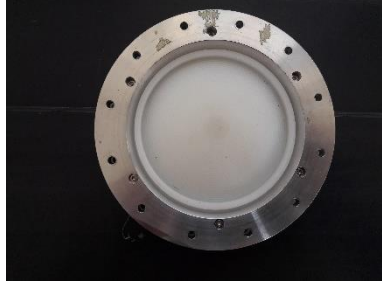
Label	Picture	Label	Picture
Flat AR Lens sample MUR 18 MURDOTEC		Flat AR Lens sample HPDE	
Flat AR Lens sample MURDOTEC		Flat AR Lens sample UHMWPE	
Flat AR Lens sample IIM2		Flat AR Lens sample HPDE	
Flat AR Lens sample MURD		Flat AR Lens sample HPDE 1	
Flat AR Lens sample GF18 36F		Flat sample 36F	

Label	Picture	Label	Picture
Flat AR Lens sample GF18 36F		Flat sample NAOJ4	
Flat AR Lens sample NAOJ18		Silicon Lens prototype	
Lens Prototype V2 for INAF optics, N.3		Lens Prototype V2 for INAF optics, N.4	
Lens prototype V1 for UdC optics		Lens Prototype V1 for INAF optics	
Lens prototype V2 for UdC optics		Silicon flat sample	

10 Final Review Deliverables

In line with Table 1 we describe here the deliverable for the final review.

based on the input provided to INAF we maintained the 3D cad models of the INAF optics configuration and of the UdC optics configuration. 3D CAD model for NAOJ configuration was under NAOJ responsibility. The two 3D models are stored in the following step files:

- B23-Prototype-INAF-Optics-Feb2019.stp
- B23-Prototype-UdC-Optics-Feb2019.stp

Based on the tests performed at Cryowaves INAF/OAS lab, the performance test report for baseline selection review has been produced and entitled '*Band 2 wideband critical components comparison: Optical efficiencies at room temperature, LNAs and prototype receiver noise performances*', has been produced under ESO responsibility and configured as:

- FEND-40.02.02.00-0065-A-REP.pdf

We include here the document tree describing the documentation relevant for this agreement.

coggle
made for free at coggle.it

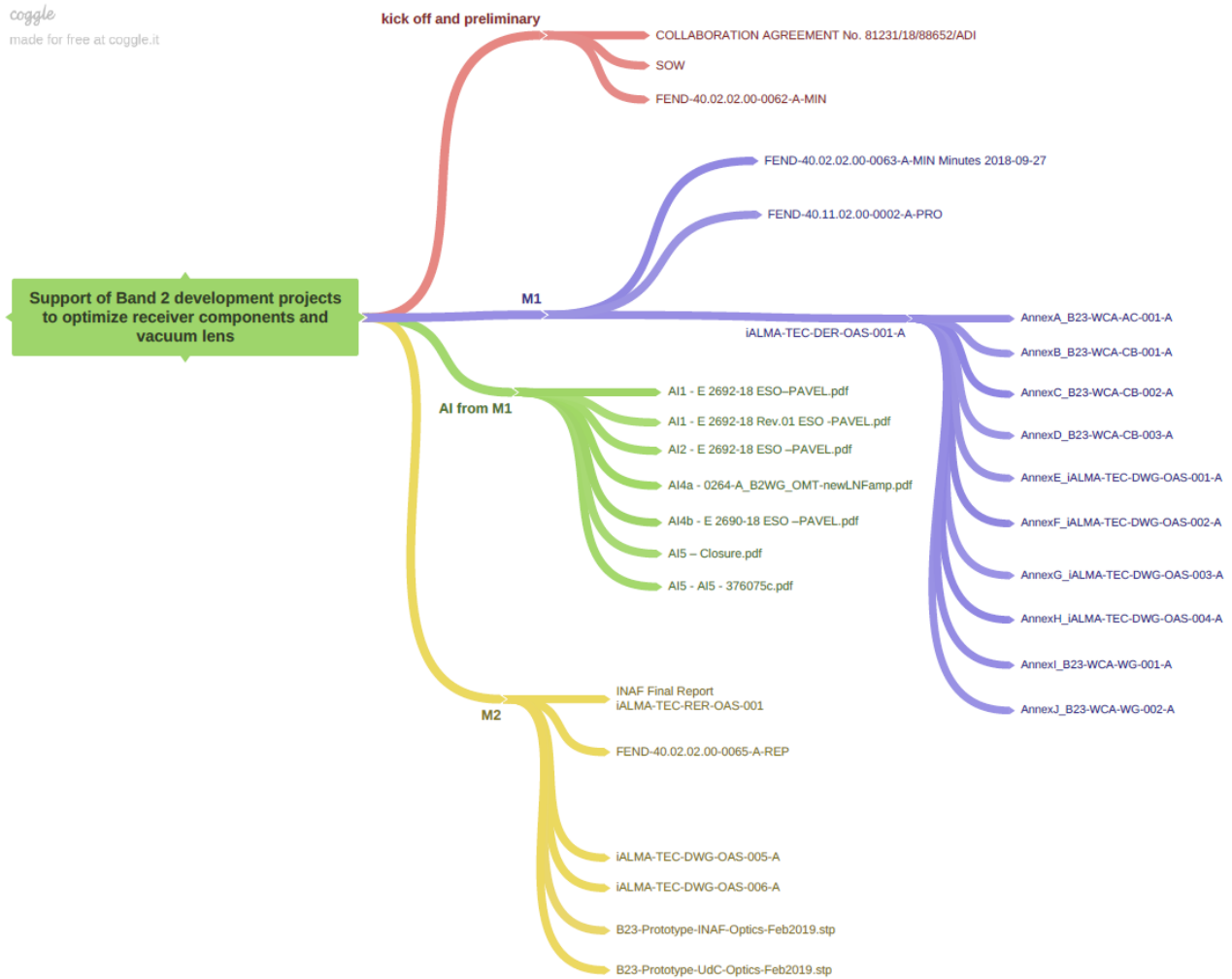

Figure 12. Document Tree of all documentation relevant to this agreement

END OF THE DOCUMENT -----