

# PROCEEDINGS OF SPIE

[SPIDigitalLibrary.org/conference-proceedings-of-spie](https://spiedigitallibrary.org/conference-proceedings-of-spie)

## X-ray mirror prototype based on cold shaping of thin glass foils

Stefano Basso, Marta Civitani, Mauro Ghigo, Joanna Hołyszko, Giovanni Pareschi, et al.

Stefano Basso, Marta Civitani, Mauro Ghigo, Joanna Hołyszko, Giovanni Pareschi, Bianca Salmaso, Gabriele Vecchi, Vadim Burwitz, Carlo Pellicciari, Gisela D. Hartner, Elias Breunig, "X-ray mirror prototype based on cold shaping of thin glass foils," Proc. SPIE 10399, Optics for EUV, X-Ray, and Gamma-Ray Astronomy VIII, 1039911 (29 August 2017); doi: 10.1117/12.2275335

**SPIE.**

Event: SPIE Optical Engineering + Applications, 2017, San Diego, California, United States

# X-ray mirror prototype based on cold shaping of thin glass foils

Stefano Basso<sup>\*a</sup>, Marta Civitani<sup>a</sup>, Mauro Ghigo<sup>a</sup>, Joanna Holyszko<sup>a</sup>, Giovanni Pareschi<sup>a</sup>, Bianca Salmaso<sup>a</sup>, Gabriele Vecchi<sup>a</sup>, Vadim Burwitz<sup>b</sup>, Carlo Pellicciari<sup>b</sup>, Gisela D. Hartner<sup>b</sup>, Elias Breunig<sup>b</sup>

<sup>a</sup> INAF - Osservatorio Astronomico di Brera (Italy)

<sup>b</sup>MPE - Max-Planck-Institut für extraterrestrische Physik

## ABSTRACT

The Slumping Glass Optics technology for the fabrication of astronomical X-ray mirrors has been developed in recent years in USA and Europe. The process has been used for making the mirrors of the Nustar, mission. The process starts with very thin glass foils hot formed to copy the profile of replication moulds. At INAF - Osservatorio Astronomico di Brera a process based on cold shaping is being developed, based on an integration method involving the use of inter-connecting ribs for making stacks. Each glass foil in the stack is shaped onto a very precise integration mould and the correct shape is frozen by means of glued ribs that act as spacers between one layer and the next one (the first layers being attached to a thick substrate). Therefore, the increasing availability of flexible glass foils with a thickness of a few tens of microns (driven by electronic market for ultra-thin displays) opens new possibilities for the fabrication of X-ray mirrors. This solution appears interesting especially for the fabrication of mirrors for hard X-rays (with energy > 10 keV) based on multilayer coatings, taking advantage from the intrinsic low roughness of the glass foils that should grant a low scattering level. The stress frozen on the glass due to the cold shaping is not negligible, but it is kept into account in the errors of the X-ray optics design. As an exercise, we have considered the requirements and specs of the FORCE hard X-ray mission concept (being studied by JAXA) and we have designed the mirror modules assuming the cold slumping as a fabrication method. In the meantime, a prototype (representative of the FORCE mirror modules) is being design and integrated in order to demonstrate the feasibility and the capacity to reach good angular resolution.

**Keywords:** X-ray telescopes, Willow glass, SGO, cold shaping, cold slumping, replication, FORCE, hard X-ray mission

## 1. INTRODUCTION OF COLD SLUMPING

The slumping process of thin glass foils has been already used for X-ray mission, i.e. NUSTAR where the foils are shaped to the theoretical shape by means of hot forming. Each layer is kept into the correct position with graphite spacers machined during integration in order to impose the correct shape and to minimize the glue thickness<sup>[1]</sup>. The angular resolution achieved is about 1 arcmin<sup>[2]</sup>.

The hot slumping is able to obtain optics with thin thickness that is very difficult to reach with a traditional direct shaping. It saves time and cost. Further improvements in term of time and cost could be achieved if the hot forming in the oven is avoided.

The modular approach of x-ray segmented optics based on sectors is useful if the optic is big and the process of a closed shell is too complex to be applied. In this way is it possible to assembly together sectors of shells similarly to the method used for normal incidence telescopes based on segments. Large mirrors are obtained by putting together smaller mirror tiles. If the realization of smaller pieces is easier, on the other hand the alignment problem becomes important and must be well considered. At INAF-Osservatorio Astronomico di Brera (OAB) a big effort has been spent in the last years to provide prototypes based on very thin segments of shells and an integration machine (IMA) has been developed for their aligning and integration. The hot slumped glasses<sup>[3]</sup> were produced in the framework of IXO/Athena project and the achieved angular resolution is in the order of 5-30''<sup>[4]</sup>, expressed as Half Energy Width (HEW).

The first attempts of cold slumping began at OAB in 2005 where flat foils of D263 glass was formed on flat mould with vacuum suction and freeze to the correct shape with the use of a rigid backplane structure and a set of ribs (*Figure 1*). During the next years the tests were mainly focused on the hot slumping approach and the cold slumping was not more studied till 2016, when the good curved moulds became available.

---

\* stefano.basso@brera.inaf.it; phone +39-02-72320496

The cold slumping method is developed with the goal of obtaining X-ray optics with an angular resolution in the range of 15-60" Half Energy Width (HEW) with a very low mass and cost<sup>[5]</sup>. The chosen mission reference is FORCE (Focusing On Relativistic universe and Cosmic Evolution)<sup>[6]</sup>, a Japanese mission studied by Jaxa, which is characterized by broadband (1-80 keV) X-ray imaging spectroscopy. The main parameters are listed in *Table 1*. Other possible applications could be eXTP<sup>[7]</sup>, a mission under study in China and IAXO<sup>[8]</sup>, a helioscope ground based for the detection of solar axions.



Figure 1 – first attempts of cold slumping of flat foils of glass (2005): the thickness of the foils was from 0.125 mm to 0.4 mm

Table 1 – Mirror module parameters for the FORCE mission

<i>Parameter</i>	<i>Value</i>
Focal length	10 m
Shell diameter (min/max)	160 / 440 mm
Shell length (par+hyp)	300+300 mm
Effective Area	782 cm <sup>2</sup> at 1 keV 127 cm <sup>2</sup> at 30 keV
Field of View	7°x7°
Angular resolution (HEW)	15"
Mass	<80 kg

A preliminary design of the mirror module has been previously presented<sup>[9]</sup>, where it was assumed that each X-ray mirror module was integrated with an “indirect” replication approach, i.e. the mould has characterized by a concave shape and the optical reflecting surface of the shells is not in contact with the mould. The second approach for the integration is the “direct” replication and this is the method used for all the cold slumping prototypes we have developed so far. The conceptual scheme is shown in *Figure 2*. The advantage of the direct integration is that there is no degradation due to the not uniformity of the glass thickness because the optical surface is directly in contact with the mould surface, but the quality of the Willow glasses measured in term of thickness is very good: the variation in the thickness has a wavy shape orientated preferentially in one direction and therefore if the orientation of the glass is kept into control during the positioning of the glass this effect is negligible for indirect integration. Concerning the shape, these glasses are characterized essentially by low frequency errors and even if the amplitude is quite high (i.e. 0.1-0.2 mm pick-to-valley) the correct shape can be almost completely recovered by after the integration process. Some example of shape and thickness is shown in section 2.2 for the glasses used in the prototype called WP3.

The thickness of the glass has been chosen considering the mould currently available. In fact the capability to support a strong bending deformation is firmly connected to the thickness, if the radius is small the thickness must be small as well, as it can be seen in *Figure 3*. Other important factors are the edge and the thermal/chemical treatments.

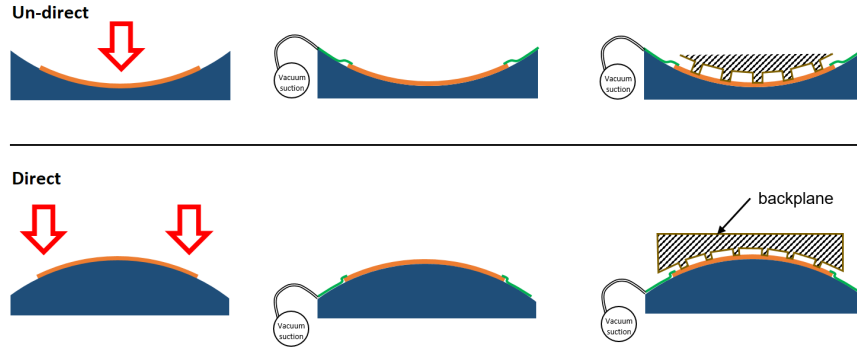

Figure 2 – Scheme of un-direct and direct integration.

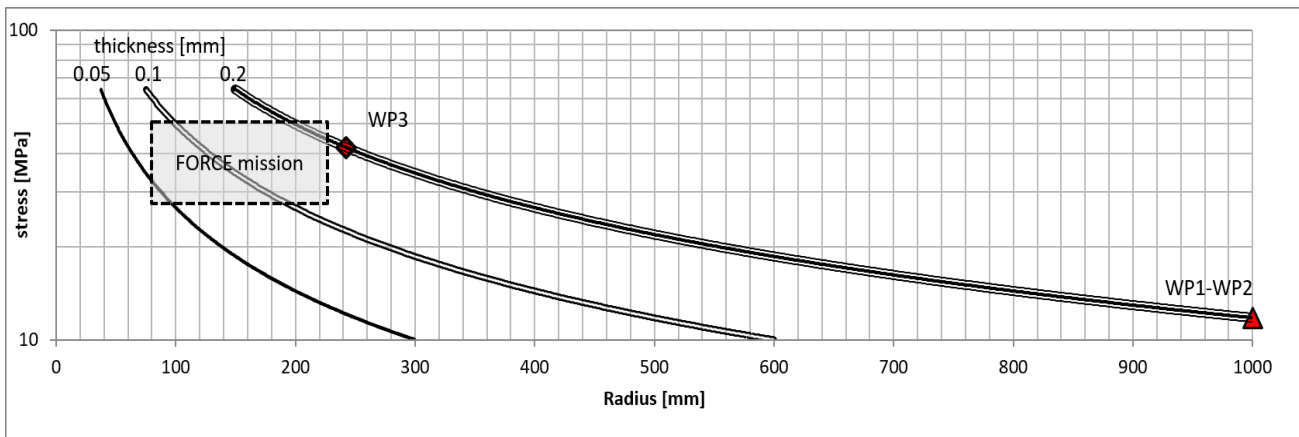

Figure 3 – Maximum principal stress [MPa] on a glass foil forced to a curved shape. WP1, WP2 and WP3 are the integrated prototype. The three thickness are the available thickness provided by Corning.

## 2. PROTOTYPES

In 2016 two breadboards have been integrated by means of IMA integration machines in order to test the problems connected to the cold slumping, WP1 and WP2 (WP is the acronym for Willow Prototype). Willow is a glass type produced by Corning. The goal for this first prototypes was not to reach immediately an optimal angular resolution but instead to demonstrate the feasibility of the process. For this reason we used low cost components. In particular, the backplane material is aluminum and there is not a complex flexing system to decouple thermal expansion. The last prototype WP3, was instead built in order to make a representative optic for FORCE mission, even if only one layer (par+hyp) was assembled. In *Table 2* the main data for the three prototypes made with cold slumping are listed. We have also reported a prototype named POC0-NASA based on glass foils produced via hot slumping, provided by NASA GSFC. This prototype can give is an indication how much is it possible to push the process with the low-cost aluminum moulds that have been developed.

Table 2 – Parameters for the integrated prototypes.

<i>Prototype</i>	<i>WP1</i>	<i>WP2</i>	<i>WP3</i>	<i>POC0-NASA</i>
Slumping	Cold	Cold	Cold	Hot
Year	2016	2016	2017	2016
Radius [mm]	1000	1000	242.5	242.5
Size [mm]	200 x 200	200 x 200	200 x 127	200 x 127
Focal length [m]	20	20	8.4	8.4
Glass thickness [mm]	0.2	0.2	0.2	0.4
Backplane material	Aluminium	Aluminium	Titanium	Titanium
N° of layers	1	1	1	1
Glass material	Willow	Willow	Willow	D263
Gap at Intersection Plane [mm]	20	20	50	50
Ribs thickness [mm]	2.8	2.8	0.7	2.8
Ribs material	BK7	BK7	Borofloat33	Borofloat33
Number of ribs	6	6	5	3
Integration mould	BK7	BK7	Aluminum	Aluminum

## 2.1 WP1 AND WP2 PROTOTYPES

The WP1 and WP2 make use of BK7 moulds with high quality with a focal length of 20 m and a radius of curvature of 1 m developed in the past for IXO project. The WP1 was the first prototype made with cold slumping tested in X-ray at PANTER/MPE facility. The results are described in ref.<sup>[10]</sup>, but summarizing, the focal spot had a PSF with 49" HEW @ 1.49 keV. The glass thickness for both WP1 and WP2 was 0.2 mm and the introduced stress was in the order of 10 MPa, much less than the stress foreseen for the FORCE module. The Willow foils was provided in the final size of 200 x 200 mm with laser cutting by Corning. The ribs used was made in BK7 with a radial thickness of 2.8 mm and a shape accuracy of 20 µm.

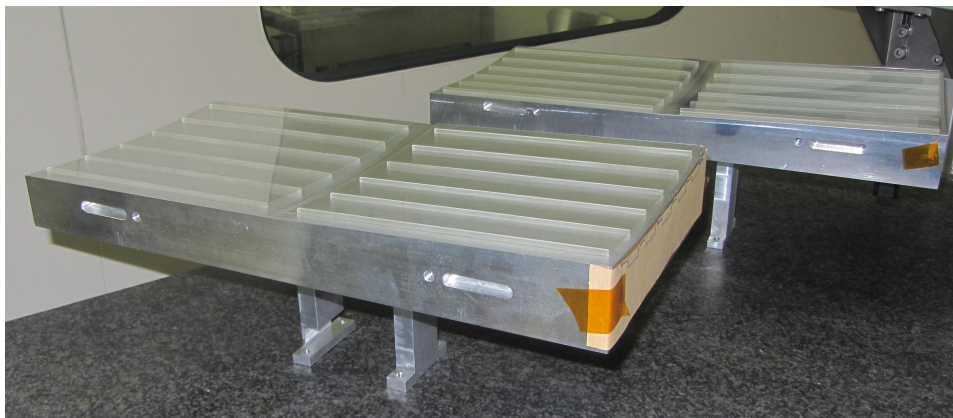

Figure 4 – WP1 and WP2

The WP2 was identical to the WP1 (Figure 4) and it was measured in UV vertical bench at OAB, as also the WP1 in order to compare the repeatability of the process. The UV measurements confirmed the X-ray results. It was also possible to change the temperature of the facility in order to test the behaviour as function of the temperature (Figure 5). This is an important topic because during the storage and transportation of the module the temperature goes far from the nominal 20 °C. As expected for a big mismatch of the CTE (3 ppm/°C for Willow and 23 ppm/°C for aluminium) the PSF changes a lot with the temperature. The interesting result was that the shape does not go back to the original shape

when the temperature goes back to 20 °C as can be seen in *Table 3*. The HEW values are computing in UV (370 nm) and for X-ray value the diffraction contribution (16.9'') must be further removed. For a Titanium backplane (CTE is 8 ppm/°C) this effect is reduced by a factor 4 if the behavior is linear. Anyway, the observed phenomenon shows that the temperature of the module should be kept within about ±3 degrees also for the Titanium backplane. This effect is possibly caused by the instability of the thin foils; in fact the PSF degradation seems stronger when the temperature is decreased and the glass foil is consequentially subjected to compression. The effect should be reduced also if the distance of the ribs is reduced.

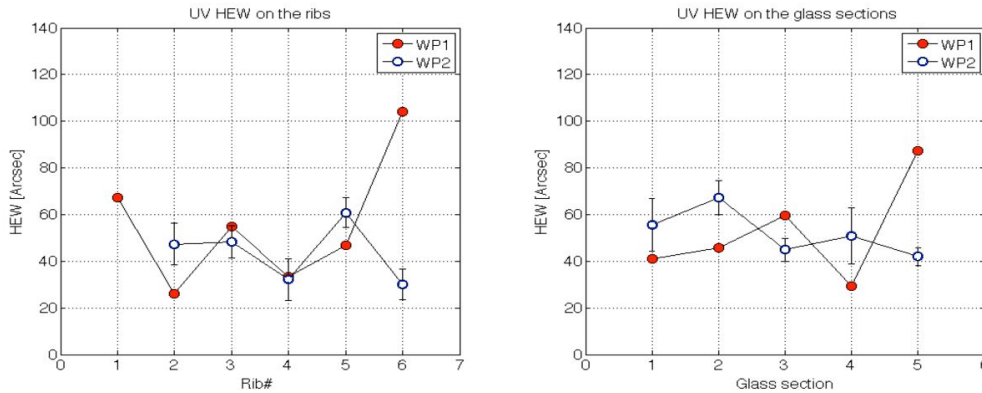

Figure 5 – WP1 and WP2 measurement in UV vertical bench @OAB. The wavelength is 370 nm and the diffraction contribute is 16.9''. The optics were masked with azimuthal window with a width of 20mm in order to test different parts of the optics.

Table 3 – PSF evolution in UV as function of the temperature. The distance of the ribs was about 38 mm.

Day	Temp. [°C]	HEW UV [arcsec]
1	20	47
2	24	53.9
3	17	70.6
4	20	57.8
7	20	61.7

## 2.2 WP3 PROTOTYPE

In order to produce a prototype representative for the FORCE mission a quite small radius of curvature is needed. Two set of moulds were available in OAB with a radius of curvature below 300mm, both made of aluminum that was diamond turned in order to obtain the desired profile. The parameters of the two independent moulds, one with a parabolic shape and the other with a hyperbolic shape (*Figure 6*), have been reported in *Table 4*. They permit to integrate glass foils with size of 200 x 130 mm and with the thickness of 0.2 mm, with a theoretical stress after integration of 42 MPa. The only process applied to the mould is the diamond turning because the concept of cost reduction was a main topic, but therefore their shape quality is not the best.

Table 4 – Moulds data

Parameter	Value
Optical configuration	Wolter-I
Focal length	8.4 m
Radius of curvature @ Intersection Plane	242.5 mm
Size	250x150 mm
Angular resolution (HEW)	15''

An improvement for the optical point of view could be a following step of figuring polishing in order to reduce the mould contribute to less than the current 15". Another improvement to the mould could be the deposition of a chemical Nickel (Kanigen) layer. In this way we will increase the durability of the mould, because the risk of scratching the surface decreases.

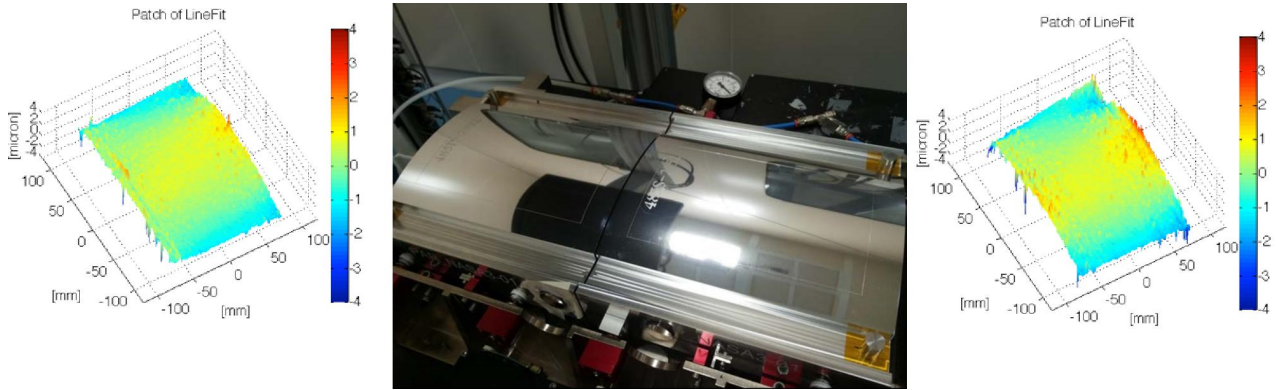

Figure 6 – Aluminum moulds used for WP3. The shape quality is not good (HEW 15"), but they were developed in order to realize low cost moulds.

Concerning the glass foils, from 200 x 200 mm sheets we mechanically cut (with a commercial glass cutter) one side in order to reduce the size to 200 x 127 mm. The thickness of the glasses measured before the cutting is shown in Figure 7. It is clear that there is a preferential direction for the waviness due to the thickness variation and therefore the cutting edge has been chosen in order to minimize this effect along in the longitudinal direction. The shape of the foils has been measured after cutting: the parabola has a pick-to-valley of 164 µm and the hyperbola of 107 µm (Figure 8).

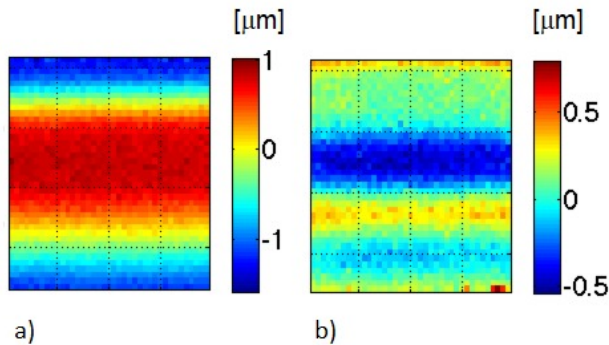

Figure 7 – Thickness variation in the glass foils used in WP3 parabolic side (a) and hyperbolic side (b).

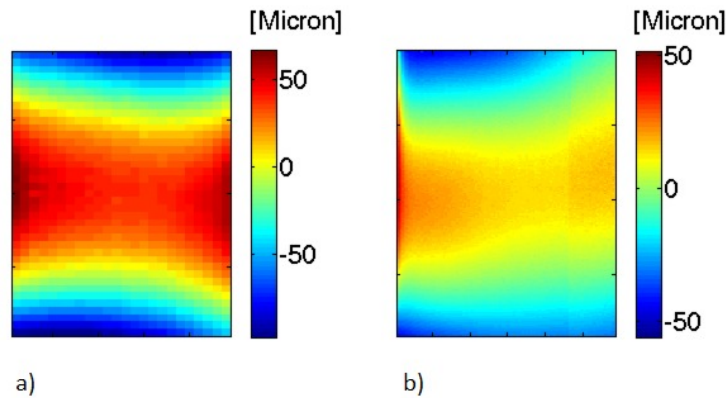

Figure 8 – Shape of the glass foils used in WP3 parabolic side (a) and hyperbolic side (b) after cutting to 200x127mm and before integration

The procurement of the ribs followed the same concept of cost reduction already adopted for the moulds. For previous programs, the ribs were realized grinding and polishing a thicker sheet of glass in order to obtain the the desired shape. The cost was pretty high (~80€/each) while the process was able to manufacture only ribs with thickness greater than 2 mm. The module of FORCE is foreseen to have ribs with a thickness in the range of 0.7-1.4 mm and for this reason for WP3 have been used ribs with a thickness of 0.7 mm. In order to demonstrate the feasibility of ribs with a very thin thickness, a new method has been used. The borofloat33 ribs were provided simply cutting them from a thin glass sheet. In this way it is not possible to realize ribs with a real wedge (in order to follow the tilted angle of two following layer of shells), but the deviation from the parallelism is in the order of precision of the planarity of the ribs their self and it will be absorbed by the glue buffer layer.

The cost of the ribs of the new process is also strongly reduced (3€/each) and making a selection is it possible to limit the planarity within 10 µm. The shape and the uniformity of the thickness of a sample of 5 ribs are shown in *Figure 9*.

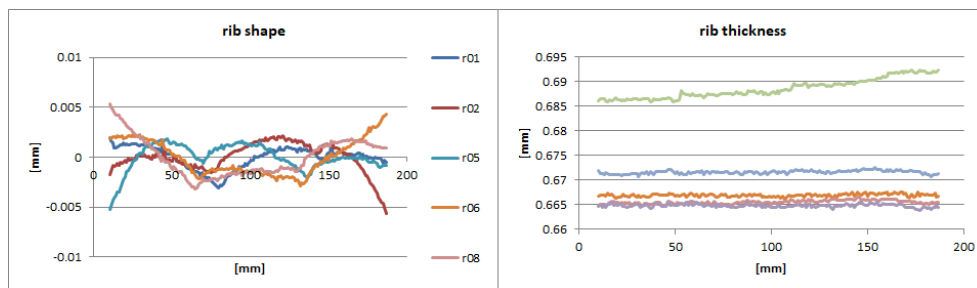

Figure 9 – Shape and thickness of a sample of 5 ribs.

For the WP3 the nominal thickness of the rib should be 1.4 mm. However we aimed at testing the difficulties to integrate very thin ribs. In order to succeed in the integration of such a thin ribs we changed the mask for alignment (*Figure 10*). While in the previous prototypes we used rigid masks to align ribs (the masks had reference contact points with the external edge of the moulds) in the new process a plastic foil (0.13 mm thickness) was cut with a cutting plotter in the appropriate shape. The small thickness lets the plastic foils follow the mould curvature and then they are simply fixed to the optical surface of the mould by means of kapton strips.

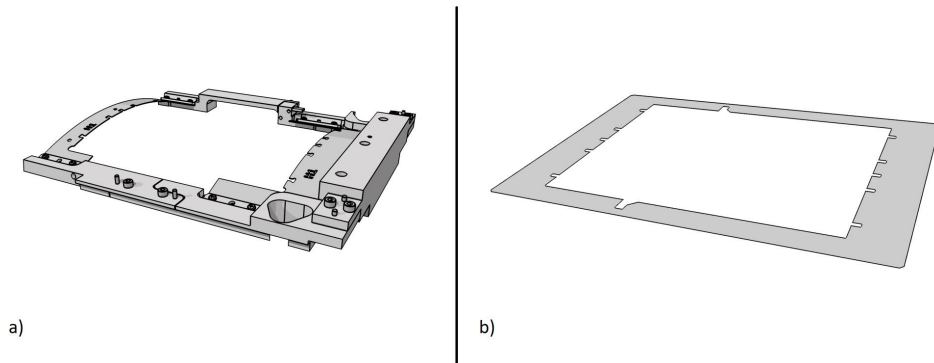

Figure 10 – Rib mask systems. A) The old configuration used in the previous prototypes and B) the new configuration used for WP3.

Aligning the glass is not a critical step as instead is for hot slumped glasses. Any mask for glass positioning has been used for that step of the integration. The mechanical structure (*Figure 11*) is composed by a Titanium backplane and stainless steel flexures that connect the backplane to an aluminum holder, used to interface the IMA and measuring supports.

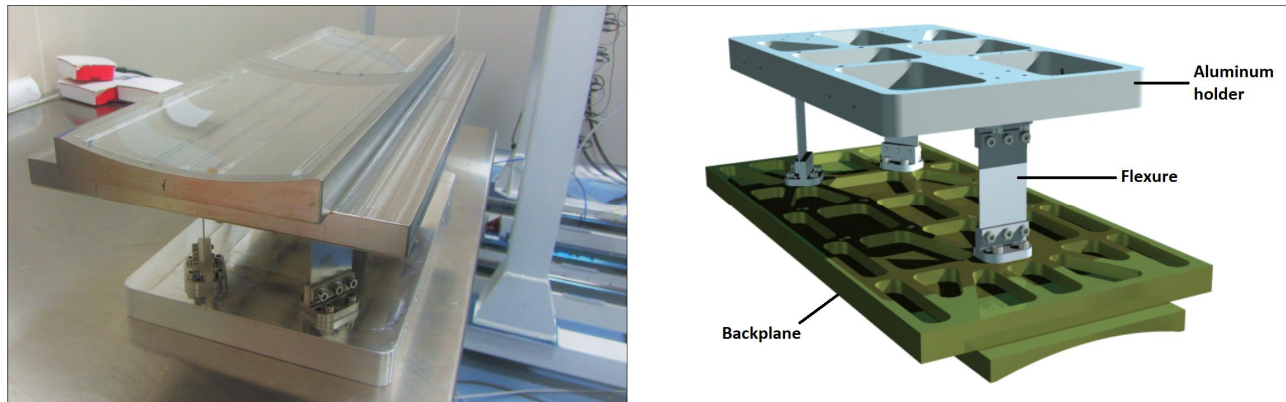

Figure 11 – WP3 and its mechanical structure

The azimuthal width of the foils is 127 mm where 5 ribs for each glass are distributed in a not uniform distance; more precisely the distance between the ribs is 38, 19, 19 and 38 mm. Outside the external ribs a portion of few millimeters is needed as usual for the vacuum suction. In these few millimeters the shape is not constrained and all spring-back appears.

Unfortunately during the positioning of the mould one of the aligning mirror used by the autocollimator of the IMA detached and it was not possible to control the angle between parabola and hyperbola. The process of gluing this mirror foresees an accurate measurement of the couple of the moulds with a 3D measuring machine (not currently available at OAB). A recovery action will be pursued in the next months. The integration was anyway finalized using a manual aligning approach, i.e. using the backplane as reference and with no close loop active. As a consequence the gluing of the ribs did not proceed in the correct way and not all the ribs resulted to be well fixed onto the backplane. The metrology has been done with CUP profilometer<sup>[11]</sup>, which have shown that only about 50% of the glass foils are well glued. The map of the longitudinal profile is shown in *Figure 12*. It should be noted that the region under the ribs well fixed shows very encouraging metrology results.

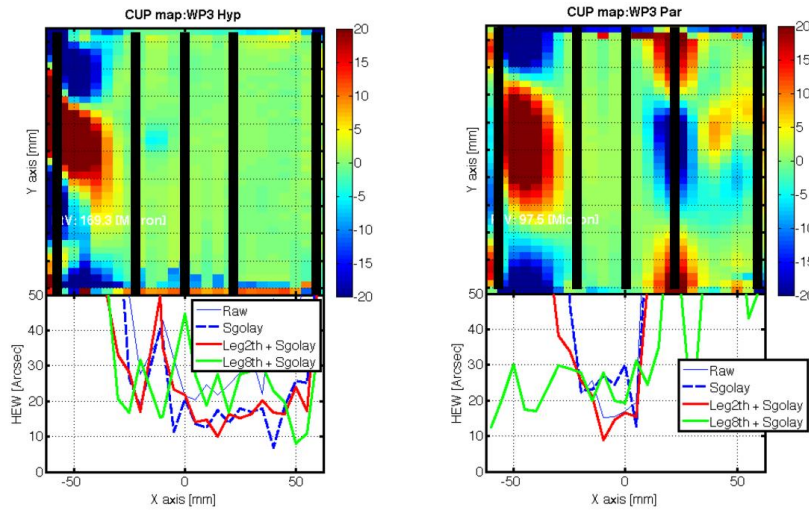

Figure 12 – Map of the longitudinal profile of the WP3: the black bars are the location of the ribs.

### 2.3 POC0-NASA PROTOTYPE

This prototype was developed using the aluminum moulds with the aim to integrate some very good glass foils developed via hot slumping by Goddard Space Flight Center. The results achieved are somehow representative on how much is possible to push the cold slumping technique with the developed low cost aluminum moulds. X-ray measurements (from 1.5 keV to 4.8 keV) have been performed at PANTER/MPE facility (*Figure 13*) in August 2017 using the TRoPIC detector. The data have been just taken a few weeks before the preparation of this paper. A preliminary analysis shows that one half of the prototype is better than the other, like it is possible to see in *Figure 14*. In order to better characterize the optic, a mask with several windows has been placed between the optic and the X-ray source. The results are reported in *Table 5*.

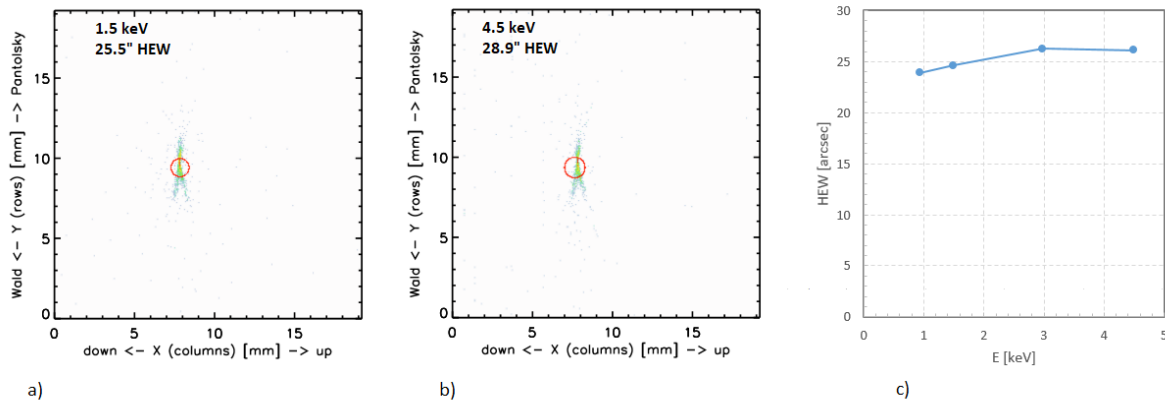

Figure 13 – POC0-NASA: x-ray measurement in full illumination at 1.5 keV (a) and 4.5 keV (b) and the trend at different energies (c).

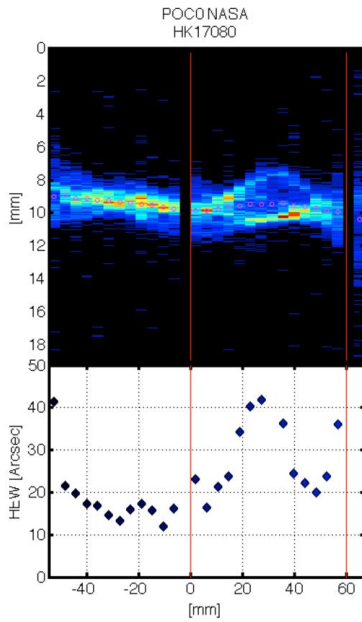

Figure 14 – POC0-NASA pencil beam measurement @ 1.49 keV. The three ribs are marked.

Table 5 – characterization of the different part of the POC0-NASA at 1.5 keV

window	HEW [arcsec]
100%	25.5
Ribs excluded	24.1
Rib 1	18.1
Rib center	26.6
Rib 2	28.0
Left side	~15''
Right side	~30''

The measurement in X-ray have been compared to the metrology recorded in OAB. The correlation is good as can be seen in *Figure 15*.

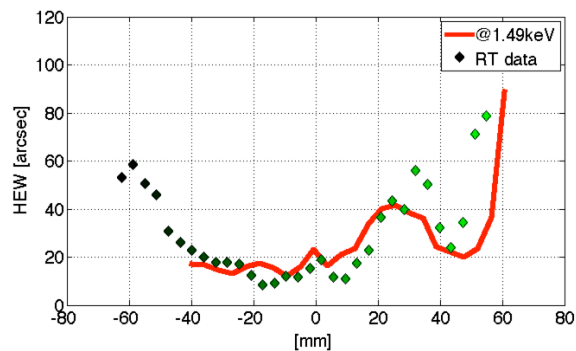

Figure 15 – Comparison of the POC0-NASA optical quality measured with x-ray at 1.49 keV at PANTER facility and the raytracing (RT) from surface metrology with CUP at OAB.

### 3. CONCLUSION

The cold slumping of very thin glass foils is a technique to produce X-ray optic with the potentiality to reach a low ratio mass/effective area. The method is attractive especially for making mirrors to work at high energy where the natural low roughness of flat glass foils is preserved and a high throughput is necessary. The low cost is a benefit, and the angular resolution should be in the order of 15-60" HEW, perhaps better.

At INAF-OAB some prototypes have been developed, like also low cost moulds. The moulds made in aluminum simply machined with diamond turning limit the achievable angular resolution to about 15-20". Another solution to reduce the cost for the mould procurement could be the adoption of active moulds that adjust their shape. A study of this topic is under investigation and the concept is explained in ref<sup>[12]</sup>.

In order to increase the optical quality of cold slumped glasses an assessment of the mould should be done but the results are promising considering that the mirror shells are very thin (0.05-0.2 mm) and the gain in the mass reduction is consistent. The reached HEW is in line with the expectation (49" for WP1) for prototypes with a low bending but we understood the source of errors and we push our effort to obtain the same result and also better for glass foils with a much bigger bending deformation, considering that the maximum stress contribute for the cold shaping is considered 50 MPa. Vibration tests should be performed to understand that the considered stress is reasonable.

### ACKNOWLEDGMENT

This research is supported by ASI. Many thanks go to W. Zhang and GSFC staff for providing the slumped glasses used in POC0-NASA prototype. The aluminum moulds have been fabricated by LT-ULTRA (Germany).

### REFERENCES

- [1] W. Craig, H. An, K. Blaedel, F. Christensen, et al., "Fabrication of the NuSTAR Flight Optics", Proc. of SPIE Vol. 8147, 81470H, (2011), doi: 10.1117/12.895278
- [2] H. An, K. Madsen, N. Westergaard, S. Boggs, F. Christensen, W. Craig, C. Hailey, F. Harrison, D. Stern, W. Zhang, "In-flight PSF calibration of the NuSTAR hard X-ray optics", Proc. SPIE 9144, 91441Q (2014)
- [3] B. Salmaso, S. Basso, C. Brizzolari, M. Civitani, M. Ghigo, G. Pareschi, D. Spiga, G. Tagliaferri, G. Vecchi, "Production of thin glass mirrors by hot slumping for X-ray telescopes: present process and ongoing development", Proc. of SPIE 9151-103 (2014)
- [4] M. Civitani, S. Basso, C. Brizzolari, M. Ghigo, G. Pareschi, B. Salmaso, D. Spiga, G. Vecchi, E. Breunig, V. Burwitz, G. D. Hartner, B. Menz, "Slumped Glass Optics with interfacing ribs for high angular resolution X-ray astronomy: a progress report", Proc. of SPIE Vol. 9603, 96030P (2015), doi: 10.1117/12.2188598
- [5] M. Civitani, S. Basso, O. Citterio, M. Ghigo, B. Salmaso, G. Pareschi, G. Vecchi, "Cold shaping of thin glass foils: a fast and cost-effective solution for making light-weight astronomical x-ray optics", Proc. of SPIE Vol. 9603, 960310 (2015), doi: 10.1117/12.2188580
- [6] K. Mori, T. G. Tsuru, K. Nakazawa, Y. Ueda, T. Okajima, H. Murakami, H. Awaki, H. Matsumoto, Y. Fukazawa, H. Tsunemi, T. Takahashi, W. W. Zhang, "A broadband x-ray imaging spectroscopy with high-angular resolution: the FORCE mission", Proc. of SPIE. 9905, 99051O. (2016) doi: 10.1117/12.2231262
- [7] S. N. Zhang, M. Feroci, A. Santangelo, et al., "eXTP: Enhanced X-ray Timing and Polarization mission", Proc. SPIE. 9905, 99051Q. (2016) doi: 10.1117/12.2232034
- [8] E. Armengaud, et al., "Conceptual design of the International Axion Observatory (IAXO)", Journal of Instrumentation, Volume 9, Issue 05, article id. T05002 (2014).
- [9] S. Basso, M. Civitani, G. Pareschi, "Design of a medium size x-ray mirror module based on thin glass foils", Proc. of SPIE. 9905, 990574. (2016) doi: 10.1117/12.2232893
- [10] M. Civitani, S. Basso, et. Al. "Cold and Hot Slumped Glass Optics with interfacing ribs for high angular resolution X-ray telescopes", Proc. of SPIE Vol. 9905, 99056U (2016) doi: 10.1117/12.2232591
- [11] M. Civitani, M. Ghigo, O. Citterio, P. Conconi, D. Spiga, G. Pareschi, L. Proserpio, "3D characterization of thin glass x-ray mirrors via optical profilometry", Proc. of SPIE. 7803, 78030L. (2010) doi: 10.1117/12.863879
- [12] M. Civitani, S. Basso, G. Pareschi, "Adjustable integration molds for X-ray optics with cold shaping: requirements and conceptual design", Proc. SPIE 9905-263, (2016)