



Rapporti Tecnici INAF INAF Technical Reports

Number	220
Publication Year	2023
Acceptance in OA@INAF	2023-01-09T17:17:21Z
Title	SRT, Medicina and Noto's 3-band receivers: performances simulations with MATLAB RFTtoolbox
Authors	BALDINI, Veronica
Affiliation of first author	IRA Bologna
Handle	http://hdl.handle.net/20.500.12386/32847 , https://doi.org/10.20371/INAF/TechRep/220

SRT, Medicina and Noto's 3-band receivers: performances simulations with MATLAB RFTtoolbox

Technical Report

Veronica Baldini (INAF-IRA)

Reviewers: Alessandro Orfei (INAF-IRA), Pietro Bolli (INAF-OAA)

PON project "Enhancement of the Sardinia Radio Telescope for the study of the Universe at the higher radio frequencies". "PIR 2018", project code: PIR01_00010.

INDEX

1	Introduction.....	5
2	Receivers expected performances	5
3	MATLAB RF Toolbox and software architecture.....	7
3.1	Receiver chain elements creations.....	7
3.2	MATLAB simulation software architecture	8
3.2.1	Notes on the receiver input power calculation.....	9
3.3	.s2p files parameters	10
4	SIMULATIONS OF THE RECEIVERS	10
4.1	3-band K receivers	11
4.1.1	3-band K LCP and RCP line simulations	12
4.1.1.1	Notes on the component measurement files included in the simulations	12
4.1.1.2	3-band K LCP and RCP simulation plots.....	14
4.1.1.3	Notes on the simulations.....	16
4.1.2	3-band K LO line.....	17
4.1.2.1	Notes on the component measurement files included in the LO lines simulations	17
4.1.2.2	3-band K LO simulation plots.....	17
4.1.2.3	Notes on the simulations.....	18
4.2	3-band Q receivers	18
4.2.1	Notes on the component measurement files included in the LCP and RCP simulations	19
4.2.1.1	3-band Q LCP and RCP simulation plots	21
4.2.1.2	Notes on the simulations.....	23
4.2.2	3-band Q LO line	24
4.2.2.1	Notes on the component measurement files included in the LO line simulations	24
4.2.2.2	3-band Q LO simulation's plots	24
4.2.2.3	Notes on the simulations.....	25
4.3	3-band W receivers.....	26
4.3.1	Notes on the component measurement files included in the LCP and RCP simulations	26
4.3.1.1	3-band W HF simulation plots	28
4.3.1.2	Notes on the simulations.....	30
4.3.1.3	3-band W HF sun simulations.....	31
4.3.1.4	3-band W LF simulation plots.....	32
4.3.1.5	Notes on the simulations.....	34
4.3.1.6	3-band W LF sun simulations.....	35
4.3.2	3-band W LO line	36
4.3.2.1	Notes on the component measurement files included in the LO line simulations	36

4.3.2.2	3-band W LO simulation plots	37
4.3.2.3	Notes on the simulations.....	37
4.4	Results and evaluations of the simulations.....	38
5	Conclusions.....	39
APPENDIX A:	Components measurement files	40
Bibliography.....		45

ACRONYMS

BPF – Band Pass Filter

CDR - Critical Design Review

HF – High Frequency

HPF – High Pass Filter

IF - Intermediate Frequency

LCP - Left Circular Polarization

LF – Low Frequency

LO – Local Oscillator

LPF – Low Pass Filter

Med – Medicina

NF – Noise Figure

OMT – Orthomode Transducer

RCP – Right Circular Polarization

RF – Radio Frequency

SRT – Sardinia Radio Telescope

TE – Transverse Electric

1 INTRODUCTION

In the context of the PON funding called “Enhancement of the Sardinia Radio Telescope for the study of the Universe at the higher radio frequencies” the realization of 3-band receivers (K band (18-26 GHz), Q band (34-50 GHz) and W band (80-116 GHz)) for the three main Italian radio-telescopes, SRT, Medicina and Noto is foreseen.

The design and construction of the receivers are under Korean Institute KASI’s (Korea Astronomy and Space Science Institute) responsibility.

The scope of this technical document is to report the main receiver parameters behavior computed with MATLAB simulations software.

Thanks to the receiver components measurement files and to the RF tools of MATLAB it was possible to simulate the gain, the noise figure (and noise temperature) and the output power of the chains of the three receivers.

These simulations can be useful to compare the estimation of the receivers at the CDR level to the real built receivers also for a better integration of the receivers with the FBCB (Full Band Conversion Board).

This board is designed to interface all the receivers to the foreseen backends.

2 RECEIVERS EXPECTED PERFORMANCES

The 3-band receivers (see Figure 1) are composed by a quasi-optics system shared by the three bands, the feed horn systems (with the circular polarizers, OMTs, couplers, isolators and LNAs) for each band that are hosted inside a 20K cooled cryostat and the receiver chain for the filtering and down-conversion operations. All the output signals are directed to the Full Band Conversion Board, that is composed by 19 conversion boards with 38 inputs, operating between 2 and 18 GHz (Orfei A. , 2019).

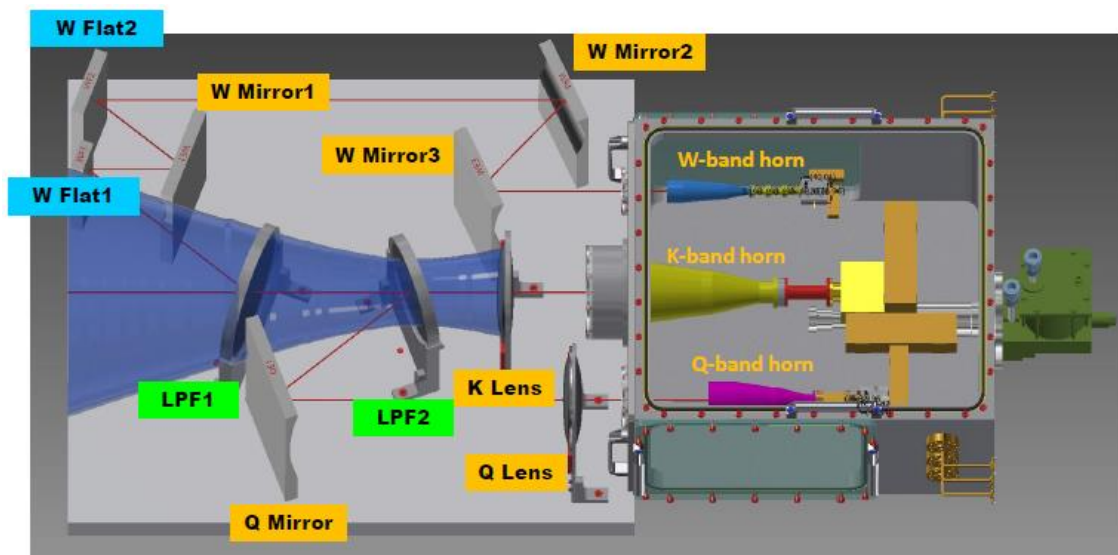

Figure 1 Optical components of the 3-band receivers (SRT case) (KASI, 2020)

Table 1 shows the original requirements of the 3-band receivers while Table 2 shows the expected performances for each receiver’s band. These values are taken from the KASI’s evaluations presented at CDR (see CDR documentation (KASI, 2020)). Soon after the CDR some modifications of the requirements reported

in the SoW have been agreed by INAF and KASI: the gain of the Q band was set to be 42 ± 2 dB, while for the W band 43 ± 4 dB. The P1dB also changed to > -10 dBm and > -20 dBm for solar observations in W-band.

Parameter	K-band	Q-band	W-band
Frequency range (GHz)	18-26	34-50	80-116
Instantaneous bandwidth (GHz)	8	16	2 x 16
Frequency coverage	Simultaneous observation capability in the three bands		
Receiver noise temperature (K) (including quasi-optics losses)	≤ 60	≤ 70	≤ 100
Receiver net gain (dB)	35	35	30
Receiver gain flatness (dB)	± 4	± 4	± 5
Output power levels (dBm)	From -50 to -10	From -50 to -10	From -50 to -10
Output return loss (dB)	< -15	< -15	< -15
Output 1 dB compression point (dBm)	> 0	> 0	> 0

Table 1 3-band receivers requirements (Bolli, 2020), taken from CDR, subsequently amended

Parameter	K-band			Q-band			W-band		
	18	22	26	34	42	50	80	98	116
Gain in band (dB)	40.1	39.6	35.1	43	43	40	39	48	42
Receiver noise temp. (k)	52	51	53	65	63	66	87	83	86
System temperature (k)	82	110	92	104	119	193	182	180	258
[sky temp., (k)]	[30]	[59]	[39]	[39]	[56]	[127]	[95]	[97]	[172]
Output power levels (dBm)	-40	-40	-45	-33	-33	-34	-35	-26	-31
Output power levels (dBm) with sun	-20	-20	-25	-14	-14	-17	-44	-37	-42
Output 1dB CP (dBm)	-5	-5	-6	-4	-6	-7	-16	-14	-15

Table 2 Expected performances of the 3-band receivers at the center and extremes frequencies of the band (Bolli, 2020) at the time of CDR.

3 MATLAB RF TOOLBOX AND SOFTWARE ARCHITECTURE

MATLAB is a numerical calculation platform equipped with interactive applications and it is used in different science and technological fields. For the simulations described in this document, the RF MATLAB Toolbox has been used (MathWorks, RF Toolbox, 2021).

The RF Toolbox provides applications and functions for the design and analysis of RF components network. In particular, the RF Budget Analyzer application (MathWorks, RF budget analyzer, 2021) allows to analyze receiver chains in terms of receiver parameters (gain, output power, noise figure, intercept point, etc.).

With the RF Budget Analyzer application, it is possible to create or visualize the receiver chain, setting the parameters of each component either on the graphical interface or manually.

3.1 RECEIVER CHAIN ELEMENTS CREATIONS

Within the RF Toolbox it is possible to configure each component of a receiver line as one of the following elements:

- Generic RF element
- Amplifier
- Modulator/Demodulator
- S parameter element
- Filter
- Transmission line

For each component, its parameters can be set from the graphical interface or directly from a configuration file. These two ways can be interchangeable. In the 3-band simulations each receiver line has a proper elements configuration file called `load_env_3bandX_real.m`, where "X" is the receiver considered. Only constant parameters can be stored in this file (not frequency dependent).

An example of graphical interface for a modulator and for a generic RF element are given in Figure 2 and in Figure 3.

Modulator Element	
Name	Mixer_MM2_0530LS
Available Power Gain	-9 dB
Noise Figure	9 dB
OIP2	Inf dBm
OIP3	10 dBm
LO Frequency	14 GHz
Converter Type	Down
Input Impedance	50 Ohm
Output Impedance	50 Ohm

Figure 2 Graphical interface for the setup of a mixer parameters

Generic RF Element		
Name	Isolator_RFL18G26GB	
Available Power Gain	-0.8	dB
Noise Figure	0.8	dB
OIP2	Inf	dBm
OIP3	Inf	dBm
Input Impedance	50	Ohm
Output Impedance	50	Ohm

Figure 3 Graphical interface for the setup of a generic RF element parameters

Once each chain component has been setup, MATLAB RF Toolbox can calculate, through the Friis formula, the overall gain, output power, noise figure, third order compression point, the signal to noise ratio and the output frequency.

These calculations are automatically performed from the RF Budget Analyzer application, by setting fixed values of input power, RF frequency and bandwidth.

3.2 MATLAB SIMULATION SOFTWARE ARCHITECTURE

For our purposes it is fundamental to simulate the receiver chains at variables input frequency values and at different input powers in order to evaluate the behavior of the receiver in the whole band. Each chain component is characterized at each frequency band and its parameters are frequency-variable. Furthermore, the input power is a variable value within the RF frequency and with the elevation angle of the telescope. RF Budget Analyzer by itself does not allow to select a variable input frequency or power.

For these reasons a custom-made software has been developed to analyze the 3-band receiver chains more deeply. The software uses the RF Toolbox and RF Budget Analyzer but implements other functionalities.

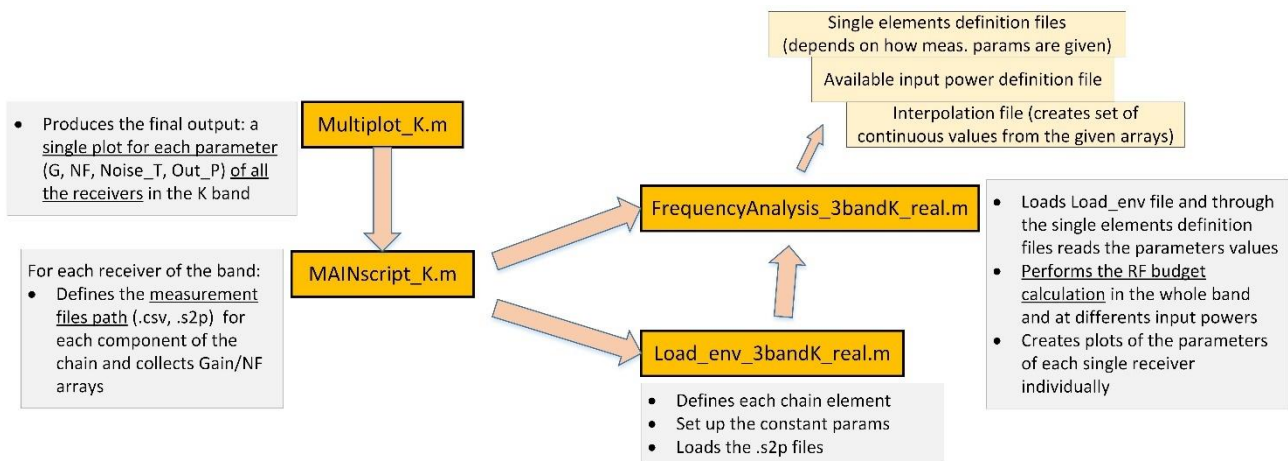

Figure 4 3-band K MATLAB simulation software architecture

Figure 4 shows the main architecture of the software developed, here the K-band is given as example.

The main software files for each band (K, Q, W) implemented are:

- **Load_env_3bandK_real.m**

In this file each element of the chain is defined, and its parameters are set. The component parameter can be set here only with constant values or with an .s2p file included. It is a kind of file that can also be automatically generated if the RF Budget Analyzer GUI is used. See also Paragraph 3.1.

- ***FrequencyAnalysis_3bandK_real.m***

This file loads the elements features stored in the Load_env_3bandK_real.m file and calls some other project files. Each element whose parameters are measured and shown in the .csv file or has parameters stored in array has a proper function that selects the way of loading of the information (e.g. finds the gain column in the .csv file). This happens for each kind of component. The path of the parameters measured files are provided by the MAINscript_K.m file. The FrequencyAnalysis file performs the calculation of the RF budget by scanning each component parameters at regular intervals of frequencies in order, at the end, to calculate the RF budget in the whole band. The calculation can be performed for different input power levels, to which are associated different output power levels.

This MATLAB script generates also a plot of the Gain, NF, noise temperature and output power for each receiver.

- ***MAINscript_K.m***

As said, in this file all the information regarding the path of the measurement file and its name are stored. Each component of each line (LCP, RCP or LO) of each receiver (Med, Noto, SRT) has been mounted and has different serial number with a proper measurement file. Due to the very wide band of the W-band (36 GHz) the receiver has been split into two sub-bands 16 GHz wide, therefore the high frequency measurement file and low frequency measurement file will be provided.

In the MAINscript file some parameters through arrays are also given (e.g. gain vs frequency, or noise temperature vs frequency)

- ***Multiplot_K.m***

This script collects the data produced by the receiver parameters calculation and gives a global plot for each parameter with all the receivers together as output. This allows a better comparison among the receivers.

3.2.1 Notes on the receiver input power calculation

As said, the input power can be a variable parameter. It is expressed by the following formula:

$$P_{in} = kT_{sys}B$$

Where k is the Boltzmann constant, B is the signal bandwidth, T_{sys} is the total system temperature generically expressed by the following formula:

$$T_{sys} = T_{sky} + T_{rx} + T_{GND} + T_{spill}$$

The system temperature depends on different factors: the sky brightness temperature T_{sky} , the receiver noise temperature T_{rx} , the ground temperature T_{GND} and the temperature caused by spillover reflections T_{spill} . Usually, the most influent values in this calculation are the T_{sky} and the T_{rx} . Really, T_{sky} , T_{GND} and T_{spill} should be weighted by the antenna illumination function but we use a simplified formula, both because the amount of the inaccuracy is not important for our purposes and also because the various parameters of the illumination function are not available.

The receiver noise temperature can be calculated converting the noise figure of the whole receiver chain. The sky temperature can be revealed from formulas that consider the models of atmospheric absorption of water vapor and oxygen at different frequencies (Cortès, 2004) and (Orfei A. , Indagine sui siti di Medicina e Noto per il loro utilizzo nella banda 90 GHz, 2006). Especially at high frequencies the vapor and oxygen absorption depends on the elevation angle of the telescope, and so does the sky temperature.

With these premises in the MATLAB code a variable input power is set for different elevation angles of the telescopes (in particular for 15° and 90°).

3.3 .S2P FILES PARAMETERS

The .snp file is a Touchstone file type (EIA IBIS Open Forum, 2002) . It collects the S parameters of 2, 3, 4 or more ports component. In our case .s2p files were available for some components.

For those components where an .s2p file is also available, the element is declared twice in the Load_env file. The first will be declared as “generic RF element”, with gain and NF specified (or passed through the MAIN_script and Freq_Analysis scripts) while the second, with the S21 column set to 0, is a “S-parameter element”. In this way both the gain/NF and mismatch information are taken into account.

.s2p files can be read and modified, for example, with Notepad++ program if necessary.

4 SIMULATIONS OF THE RECEIVERS

The simulations of each of the three receivers are described in the following paragraphs. The main lines (LCP and RCP) have been simulated, together with the LO line. Also the sun observation mode was considered and simulated. The noise calibration lines have not been simulated.

For each receiver some notes on the measurement files used in the simulations are given. The parameter measured can be:

- The gain
- The noise temperature
- The S parameters

No intercept point was measured so the overall receiver intercept point was not included in the simulations. The measurement files provided by KASI (or by the manufacturer) and added to the simulations can be of different format:

1. Constant values. Constant values are set in the load_env_3bandX.m file when no frequency variable file is provided. Usually, the value is taken or from the datasheet of the component or from the estimation declared in the CDR. The parameter set as constant is the gain (and the NF, declared or calculated)
2. .txt or .xls or .csv file. The gain, and, if provided, the NF or noise temperature have been measured by KASI in the whole frequency band and stored in one of these file formats. In the MATLAB project the values are directly loaded from a .csv file or copied in the MAIN_Script.m file for each band.
3. .s2p file. If available, the S parameters of the component are stored in .s2p file and included in the simulations. As said, an element characterized by .s2p file is doubled in the MATLAB chain: the first contain the gain features and the second the .s2p file with the S21 related column set to 0. This happens also because both (.csv o .xls) gain and .s2p files can be available for a set of components.

Multiple plots are provided for each receiver line: gain, output power, NF and noise temperature. Each plot shows the behavior of that parameter for each receiver (Medicina lcp, Medicina rcp, Noto lcp, Noto rcp, SRT lcp and SRT rcp). Each component parameter has been calculated at a specific temperature (usually 20 K if

inside the cryostat, 290 K if outside and 160 K if it is a vacuum window o a W/G flange of interface between the cryostat and the hot part of the receiver).

For each receiver, two graphs for the output power levels are produced, at 15° and 90° of elevation.

In the receivers block diagrams the TE01 or TE10 modes are marked. TE01 is associated to the line B while TE10 to the line A. The serial numbers of the component mounted are reported in (Orfei A. , CTRs block diagram update & serial numbers, based on the revision by ST. Han, 2021) where there is the association of each serial number to the corresponding receiver line. In these tables lcpA, lcpB, rcpA, rcpB are marked as the receiver lines. The real association with the right or left polarization will be done during the commissioning phases of the receivers.

Each of the following subparagraphs is organized as follows:

- General notes on the receiver (with block diagram)
- Notes on the measurement files of the components
- Results of the simulations
- Notes and comments on the simulations

4.1 3-BAND K RECEIVERS

Figure 5 shows the final design of the 3-band K receivers with their main components. This schematic is valid for Medicina, Noto and SRT receivers. Some changes are present in the final design respect to the design presented at the CDR: some components have been added (like the cold WG adapters, the W/G bend etc.) and some further details, especially on the cables and waveguides, have been provided (e.g. the type and conversion loss of the SUS cables used). These changes may affect the overall performances of the receivers and are present in every receiver.

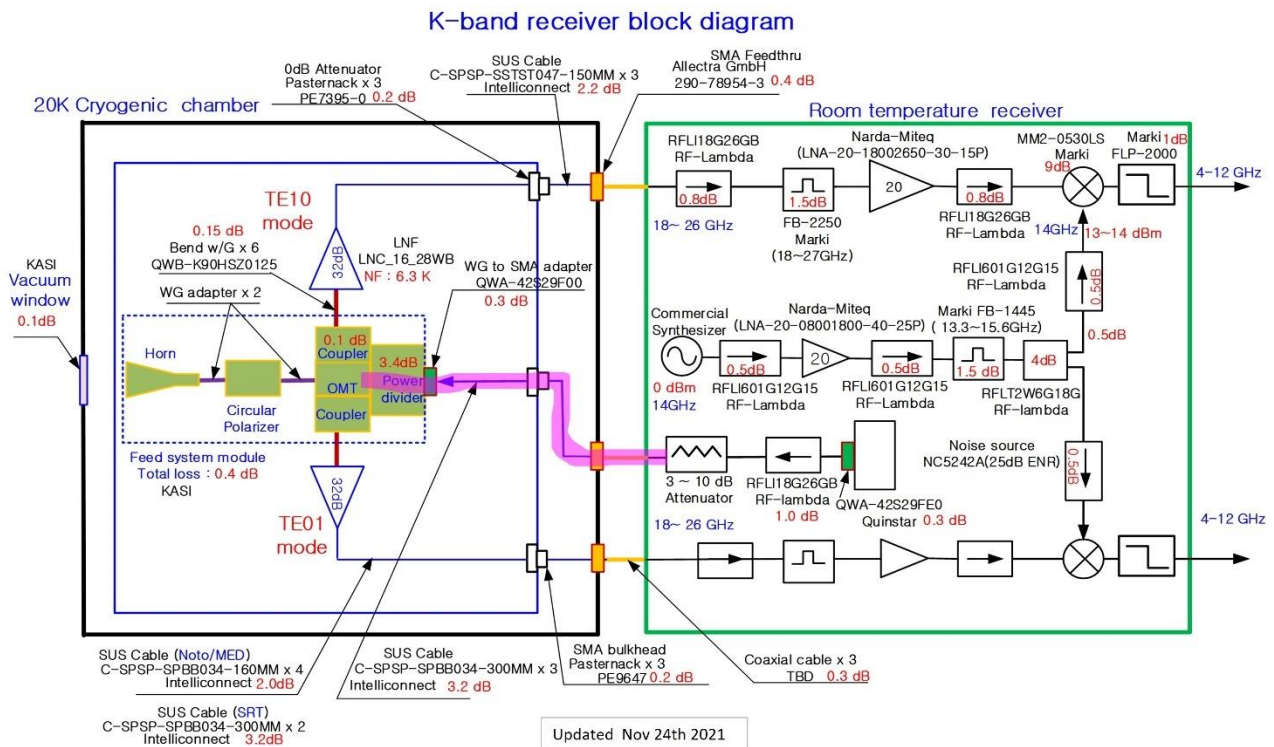

Figure 5 Block schematics of the 3-band K receivers

4.1.1 3-band K LCP and RCP line simulations

4.1.1.1 *Notes on the component measurement files included in the simulations*

For some cold components, only constant values of gain and noise figure were provided, therefore no measured files have been included in the simulations.

The horn, the circular polarizer, the OMT and the coupler are considered as a unique feed system module, with 0.4 dB of constant loss.

The serial number of each component correspondent to each receivers line is reported in Table 3, taken from (Orfei A. , CTRs block diagram update & serial numbers, based on the revision by ST. Han, 2021). For the simulation the corresponding measurement files have been used. If the measurement files were not available, constant values taken from the block diagram were taken. In some cases, when the component has a pretty constant value within the band, a constant value was considered.

Component	main RF chains K-band		SEQUENCE of SERIAL NUMBERS and CONVERSION LOSS (dB)					files used
	Model	MED Lcp(B)	MED rcp(A)	NOTO lcp(B)	NOTO rcp(A)	SRT lcp(B)	SRT rcp(A)	
QO		0.46 dB						-
Window		0.1 dB						-
Horn		Feed system module: 0.4 dB total loss considered (waveguide adapters included)						-
Polarizer								-
OMT-Coupler								-
Bend W/G	QWB- K90HSZ0125	0.15 dB						-
LNA	LNF- LNC16_28WB	No serial number available, used SN130						.txt, .s2p
SUS cable	C-SPSP- SPBB034- 160MM (Noto/Med) C-SPSP- SPBB034- 300MM (SRT)	2 dB or 3.2 dB						-
SMA bulkhead	Pasternack PE9647	0.2 dB						-
SUS cable	C-SPSP- SSTST047- 150MM	2.2 dB						-
Thru	290-78954-3	No serial number available, used sn20101500012						.xls, .s2p
Coax cable		0.3 dB						-
Isolator	RFLI18G26GB	20101500014	20101500019	20101500021	20101500025	20101500020	20101500028	.csv, .s2p
RF Filter	FB2250	Serial number not available, used SN04						.csv, .s2p
AMP	LNA-20- 18002650-30- 15P	2182784	2182780	2182781	2182779	2182778	2182785	.csv
Isolator	RFLI18G26GB	20101500016	20101500026	20101500018	20101500023	20101500024	20101500017	.csv, .s2p
Mixer	MM2-0530LS	No serial number available, used sn1. Interpolation from .pdf						.pdf
IF Filter	FLP2000	No serial number available, used sn1						.csv, .s2p

Table 3 Sequence of serial numbers, measured files or constant conversion loss considered in the simulations

In Table 3 the conversion loss considered is reported, when no serial number and/or measured file was available. That value is considered as constant within the band.

It has to be noted that the gain of the cyogenic LNA is on average 2 dB under the estimation provided at CDR. Gain and NF of the SUS cable of 160 mm (for Med and Noto) and 300 mm (for SRT) are considered constant in the whole band but different for the two types.

4.1.1.2 3-band K LCP and RCP simulation plots

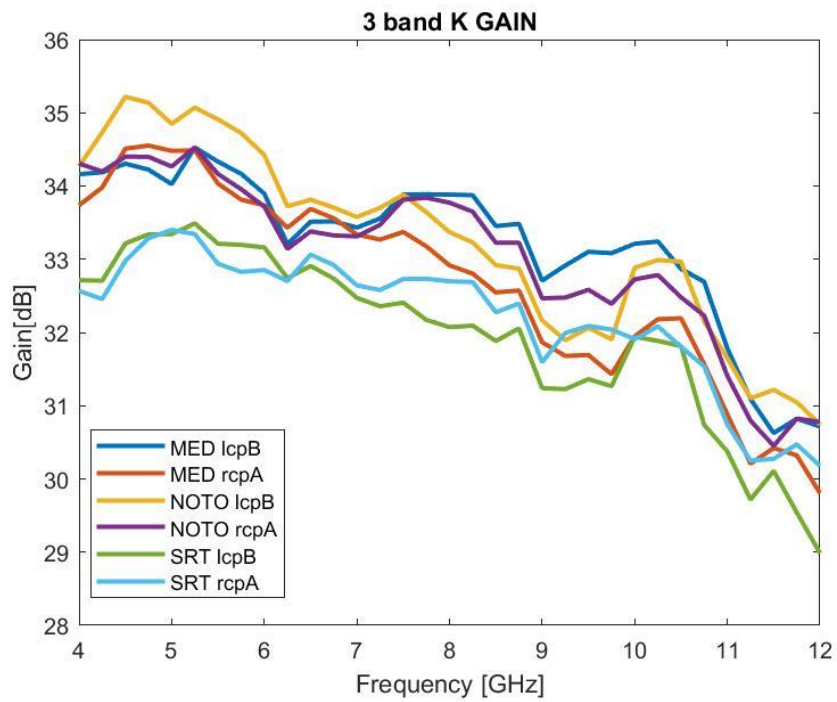

Figure 6 3-band K receivers gain

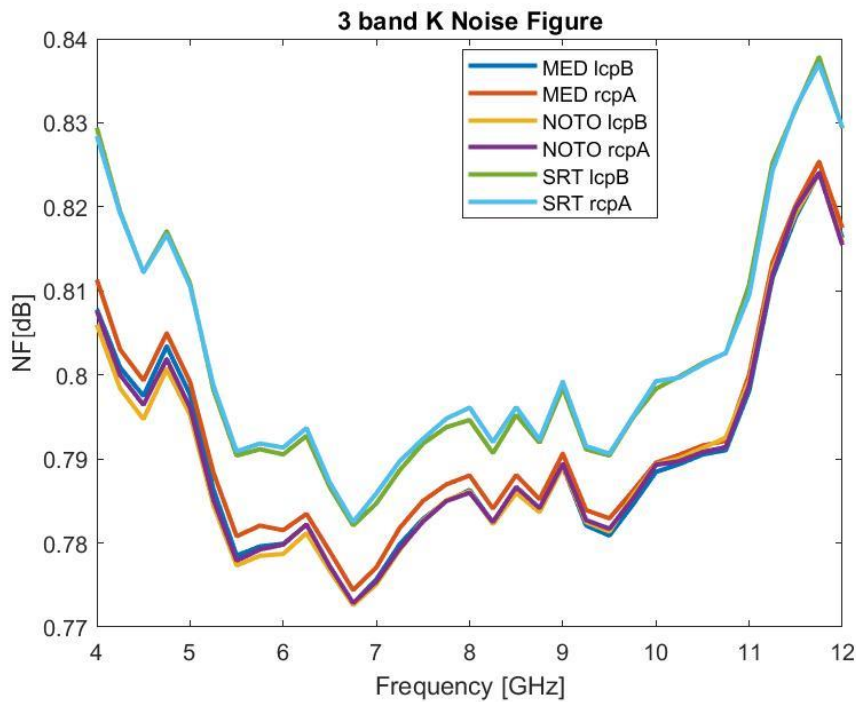

Figure 7 3-band K receivers noise figure

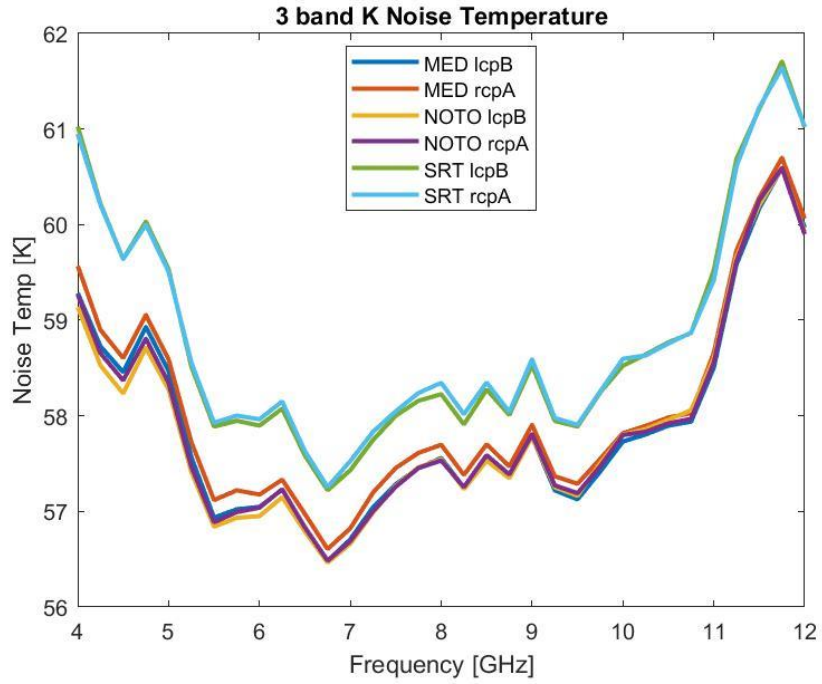

Figure 8 3-band K receivers noise temperature

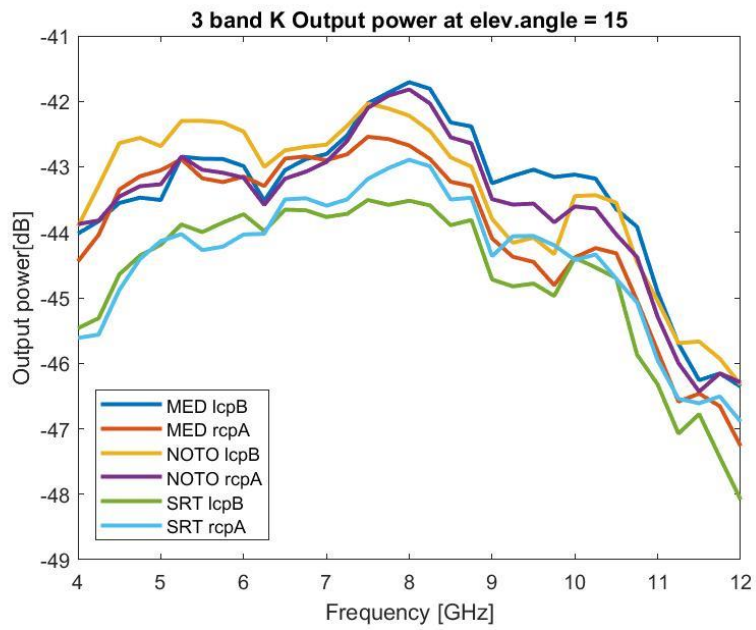

Figure 9 3-band K receivers output power levels at 15° of elevation

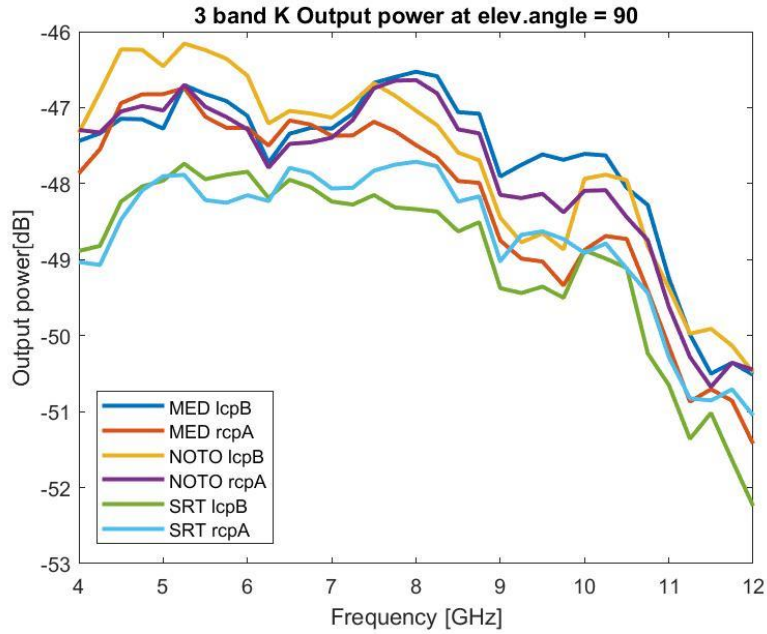

Figure 10 3-band K receivers output power levels at 90° of elevation

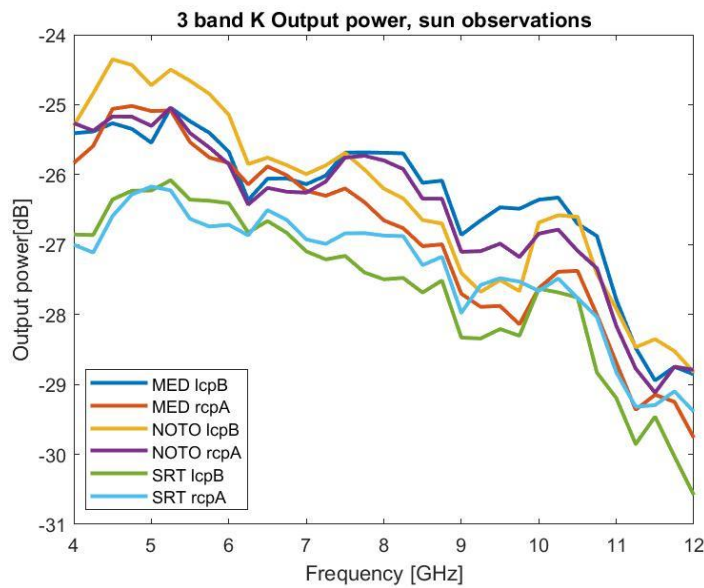

Figure 11 Output power levels for sun observations, K-band ($P_{in} \approx -59.5$ dBm),

4.1.1.3 Notes on the simulations

Figure 6 shows a gain at least 5 dB under the CDR estimated values. The introduction of new elements or higher loss components in the cryostat may be one of the causes of this behavior.

The SUS cables are different for Noto/Med and for SRT, with more than 1 dB of conversion loss of difference. This is one of the causes of the worst performance for the SRT receiver lines respect to the other receivers. Another important consideration is that the measurements of the gain of the cryogenic LNAs are about 2 dB under the declared value at CDR.

Due to this, it can be seen a light worsening of the expected performances also in the noise figure and noise temperature plot.

Figure 11 shows the output power in the case of solar observations. The sun temperature considered in the K band is 10000 K. The receiver temperature is negligible in this case. The input power calculated and set in the simulations is -59.5 dBm.

The output power estimation in case of solar observation in the K band are from -19.5 dBm (at 18 GHz) to -24.5 dBm (at 26 GHz). (KASI, 2020)

4.1.2 3-band K LO line

4.1.2.1 Notes on the component measurement files included in the LO lines simulations

For the LO lines of the K-band please have a look to the Table 4 for the serial number association and measurement file used in the simulations.

Component	LO chains K-band Model	SEQUENCE of SERIAL NUMBERS			files used
		MED LO	NOTO LO	SRT LO	
Isolator	RFLI601G12G15	20091800276	20091800277	20091800284	.csv, .s2p
Amp Miteq	LNA-20-08001800-40-25P	2179645	2179646	2179644	.csv
Isolator	RFLI601G12G15	20091800283	20091800274	20091800273	.csv, .s2p
BPF filter	FB-1445 (13.3 ~ 15.6 GHz)	No serial number available, considered sn3			.csv, .s2p
Power divider	RFLT2W6G18G	20060100055	20060100050	20060100053	.csv, .s2p
Isolator lcp(B)	RFLI601G12G15	20091800275	20091800272	20091800280	.csv, .s2p
Isolator rcp(A)	RFLI601G12G15	20091800279	20091800281	20091800282	.csv, .s2p

Table 4 Sequence of serial numbers and available measure files, 3-band K receivers, LO lines

4.1.2.2 3-band K LO simulation plots

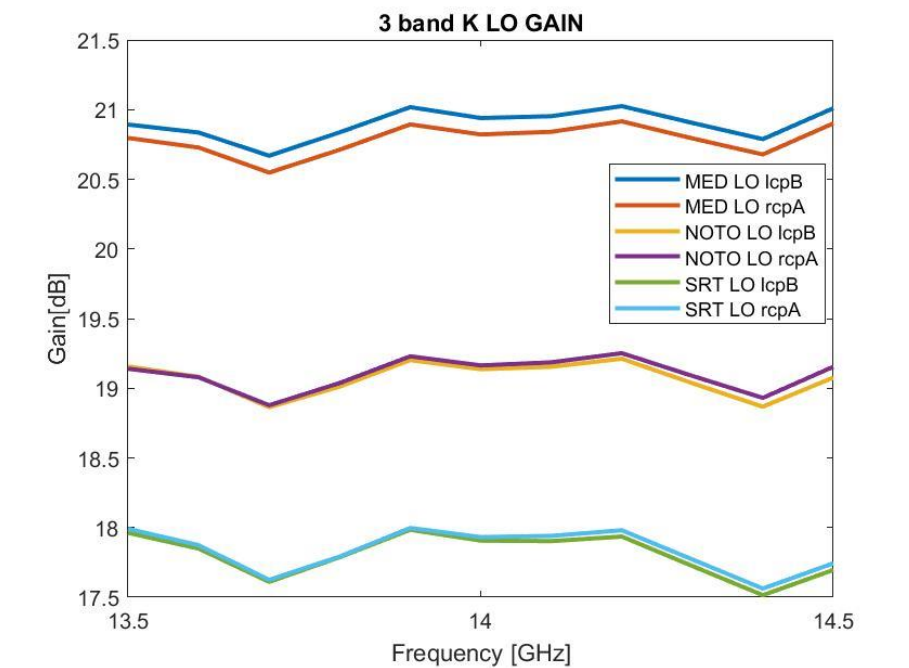

Figure 12 Gain of the LO line for each K-band receiver

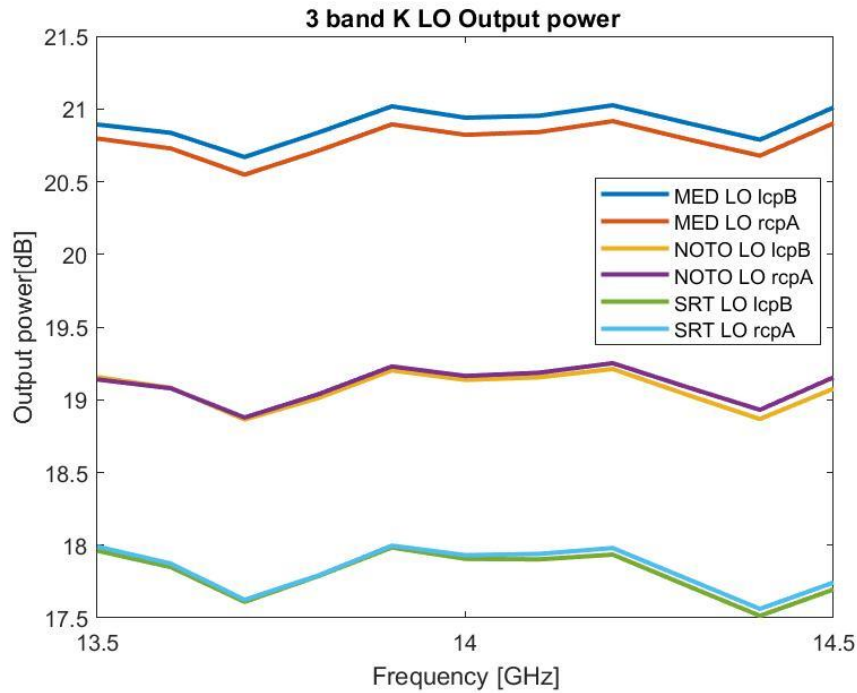

Figure 13 Output Power of the LO line for each K-band receiver

4.1.2.3 Notes on the simulations

The simulations are performed for a 1 GHz bandwidth near the LO frequency (14 GHz).

The expected input power at the LO mixer port is 9 to 17 dBm. The input power set at the synthesizer is 0 dBm.

The LNA Narda Miteq has quite different gain values for each serial number (from 23 to 25-26 dB), this produces different values of output gain for the different receivers. The power levels are a little above the expected range, but the power output of the synthesizer can be accordingly regulated.

4.2 3-BAND Q RECEIVERS

Figure 14 shows the Q-band receivers for Medicina and Noto, while Figure 15 shows the block diagram of the SRT receiver. The LCP and RCP lines of each receiver as well as the Med/Noto and SRT have some differences (e.g. the SUS waveguides conversion loss). As for the K-band, the final design of the Q-band shows some differences with the previous design, especially in the cold section.

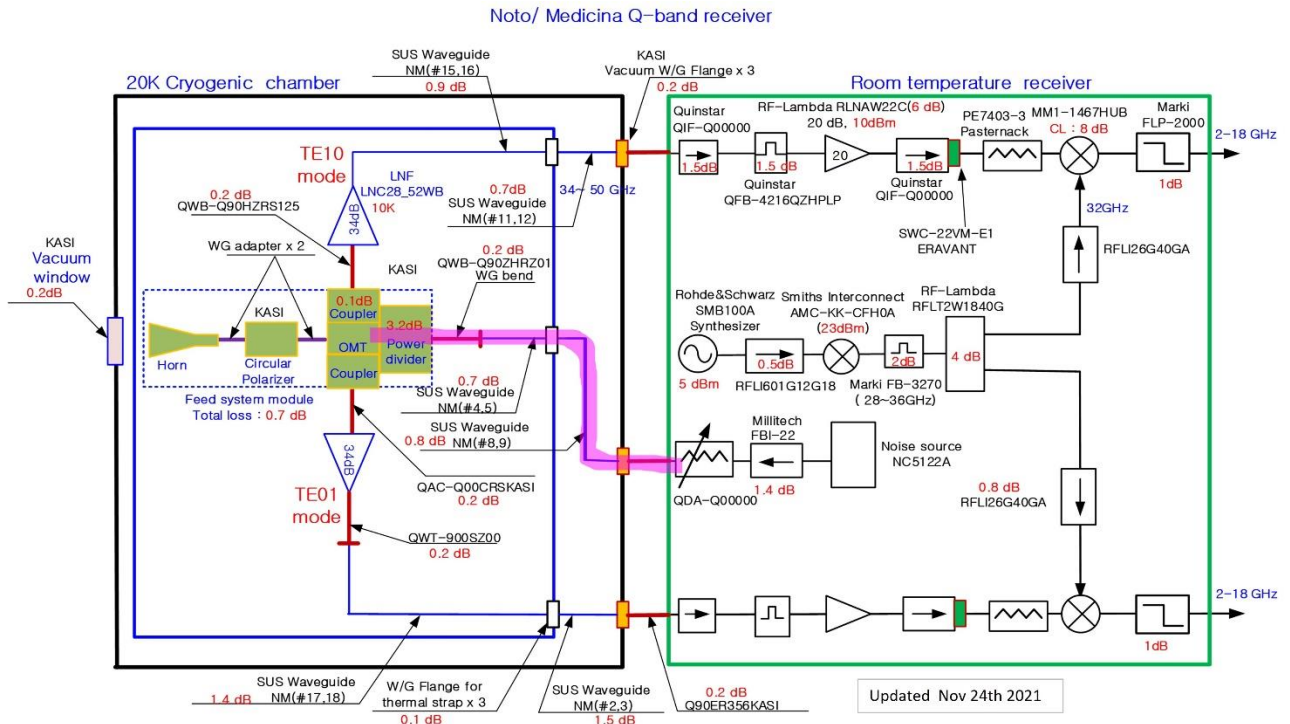

Figure 14 Medicina and Noto Q-band receivers block diagram

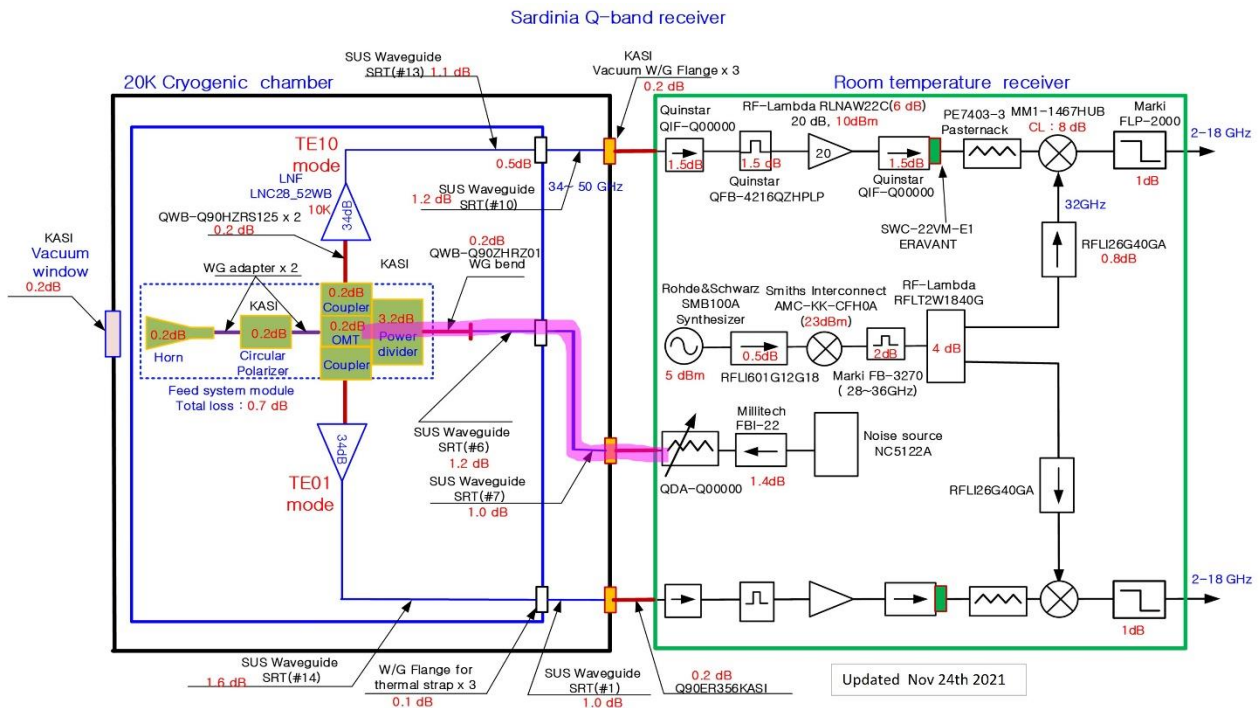

Figure 15 SRT Q-band receiver block diagram

4.2.1 Notes on the component measurement files included in the LCP and RCP simulations

Horn, circular polarizer, OMT and coupler are considered as a unique Feed system module, with 0.7 dB of constant loss, as reported in the block diagram.

If not specified hereafter, the serial number of each component correspondent to each receivers line is reported in Table 5, taken from (Orfei A. , CTRs block diagram update & serial numbers, based on the revision

by ST. Han, 2021). When no measurement file was provided, the conversion loss considered (generally taken from block diagram) is reported.

Component	main RF chains Q-band Model	SEQUENCE of SERIAL NUMBERS or CONVERSION LOSSES (dB)						files used
		MED Lcp(B)	MED rcp(A)	NOTO lcp(B)	NOTO rcp(A)	SRT lcp(B)	SRT rcp(A)	
QO		0.38 dB						-
Window		0.2 dB						-
Horn		0.7 dB (waveguide adapters included)						-
Polarizer								-
OMT-Coupler								-
Waveguide	QWB-Q90HZRS125	0.2 dB						-
SUS waveguide		0.9 dB (Noto, Med), 1.1 dB (SRT)						-
LNA	LNF-LNC28_52WB	No serial number available, considered sn065						.txt, .s2p
W/G straps	KASI, Thermal straps	0.1 dB						-
SUS waveguide		0.7 dB (Med, Noto, TE10), 1.5 dB (Med, Noto, TE01), 1.2dB (SRT, TE10), 1.0 (SRT, TE01)						-
W/G Thru	Brass with gold plate	0.2 dB						-
Cable	Q90ER356 KASI	0.2 dB						-
Isolator	QIF-Q00000	No serial number available, considered sn1444800009						.csv, .s2p
RF Filter	QFB-4216QZHPLP	1445000001	1445000005	1445000004	1445000003	1445000000	1445000002	.csv, .s2p
AMP	RLNAW22C	20111000011	20111000005	20111000014	20111000013	20111000009	20111000010	.xls
Isolator	QIF-Q00000	No serial number available, considered sn1444800009						.csv, .s2p
Adapter	SWC-22VM-E1-V	10779-07	10779-02	10779-05	10779-01	10779-03	10779-04	.xls
Attenuator	PE7403-3	3 dB						-
Mixer	MM1-1467HUB	No serial number available, considered sn03, values from .pdf interpolation						-
IF Filter	FLP2000	No serial number available, considered sn02						.csv, .s2p

Table 5 Sequence of serial numbers or conversion losses considered, 3-band Q receivers

No serial number was provided for the mixers and the measurement files of the conversion losses don't seem consistent: they are available only from 46 GHz and the values are up to 3dB higher than expected from the datasheet. The values of conversion loss included in the simulations are taken from the mixer datasheet. These values are at least 1 dB lower than the ones declared at the CDR (-7.5/-8 dB in comparison to -6.5 dB of the CDR tables).

Medicina, Noto and SRT receivers shows some differences in the Q band (see Figure 14 and Figure 15), e.g. in the waveguide and cable choice. In particular, two SUS waveguides have different values of conversion

loss for each telescope (and for each receiver polarization line). These values have been set in the MATLAB code as constant values since no measurement files were available.

4.2.1.1 3-band Q LCP and RCP simulation plots

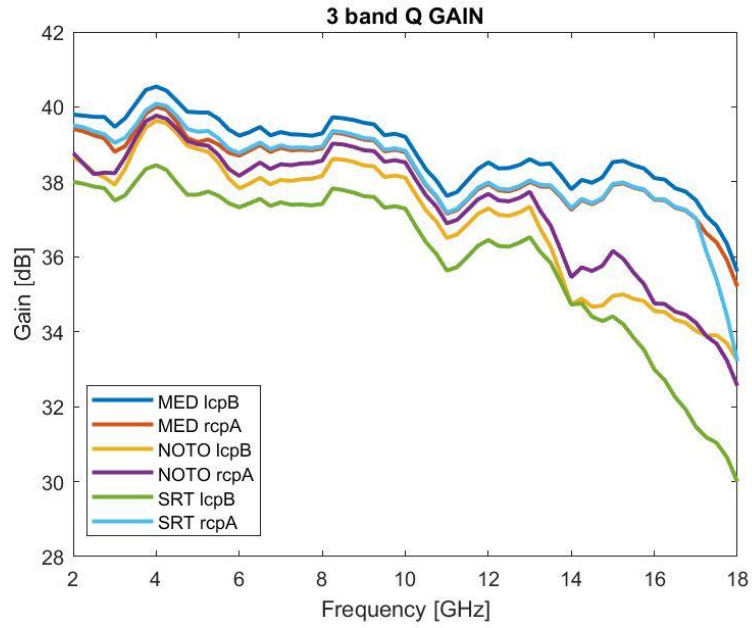

Figure 16 3-band Q receivers gain

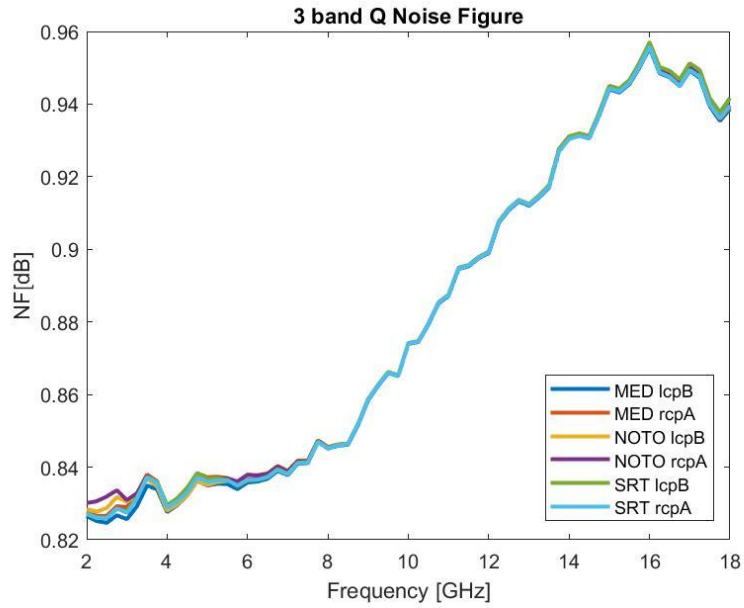

Figure 17 3-band Q receivers noise figure

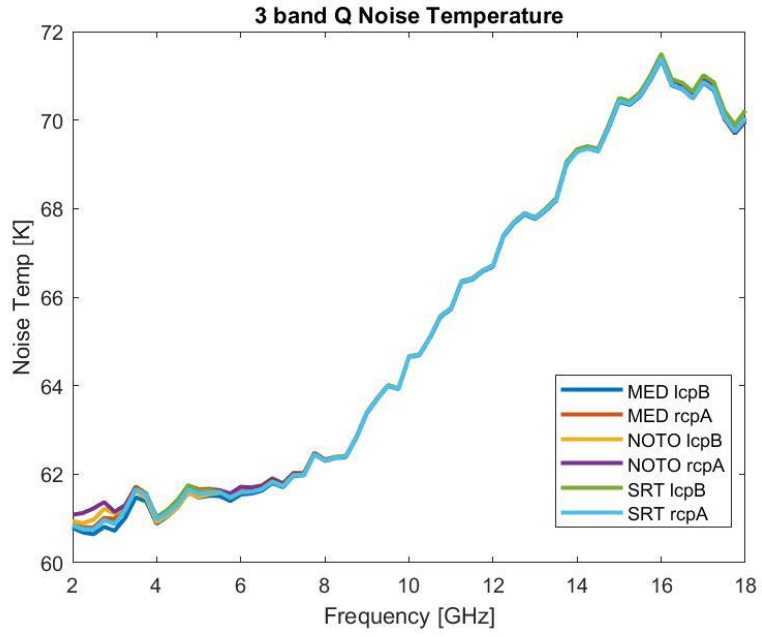

Figure 18 3-band Q receivers noise temperature

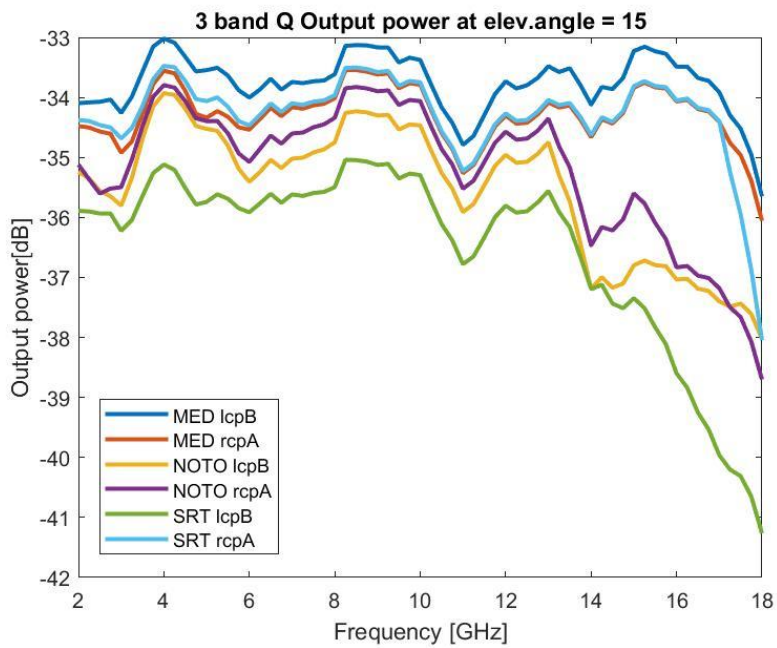

Figure 19 3-band Q receivers output power at 15° of elevation

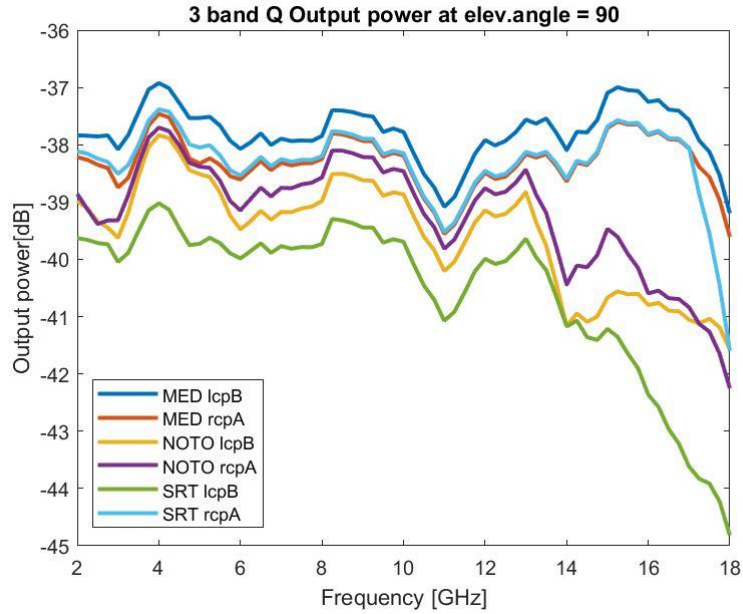

Figure 20 3-band Q receivers output power at 90° of elevation

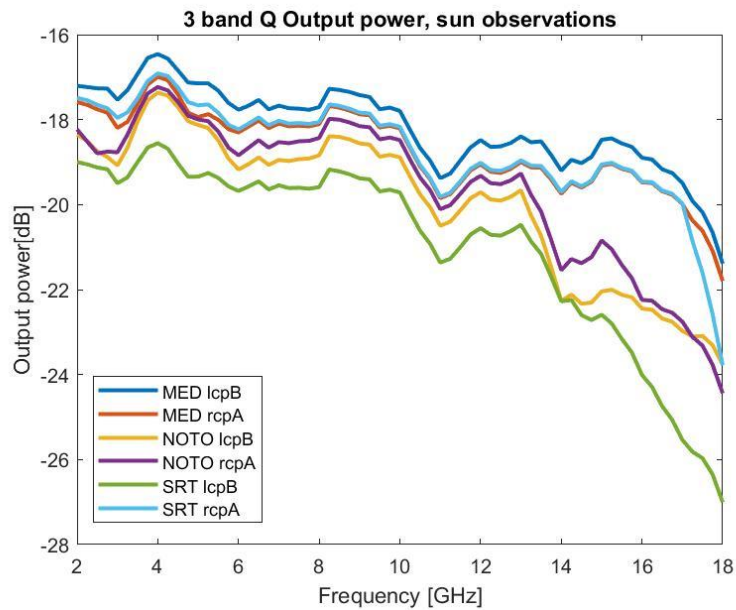

Figure 21 Output power levels for sun observations, Q-band ($P_{in} \approx -57$ dBm),

4.2.1.2 Notes on the simulations

Even in these receivers, the new cold components and cables added to the final design caused a worsening in the gain simulations, respect to the values declared at CDR. The worsening happens also because the cryogenic LNAs have about 31 dB of measured gain, against the 34 dB declared in the CDR.

The collapse of the gain at the higher frequencies of the Q-band for each receiver is caused by the RLNAW22C behavior at that frequencies.

The mixer conversion loss has different values at higher or lower frequency of the band: it is about -7 dB at 34 GHz and -9 dB at 50 GHz.

Figure 21 shows the output power in the case of solar observations. The sun temperature considered in the Q band is 9000 K. The receiver temperature is negligible in this case. The input power calculated and set in the simulations is -57 dBm.

The output power estimation in case of solar observation in the Q band are from -13.9 dBm (at 34 GHz) to -17.3 dBm (at 50 GHz). (KASI, 2020).

4.2.2 3-band Q LO line

4.2.2.1 Notes on the component measurement files included in the LO line simulations

Table 6 shows the association between the serial number and the receiver and if the measurement file was available. For the multipliers only .pdf file were available. Constant values of gain were considered (about 20.7 dB).

<i>Component</i>	<i>LO chains Q-band</i> <i>Model</i>	SEQUENCE of SERIAL NUMBERS			Measure file available and used
		MED LO	NOTO LO	SRT LO	
Isolator	RFLI601G12G18G	20070700029	20070700031	20070700026	.csv, .s2p
LO x2 active multiplier	AMC-KK-CFH0A	3000	3002	3001	.pdf
BPF filter	FB-3270	No serial number available, considered sn03			.csv, .s2p
Power divider	RFLT2W1840G	20092400006	20092400007	20092400005	.csv, .s2p
Isolator lcp	RFLI26G40GA	20111600097	20111600106	20111600115	.csv, .s2p
Isolator rcp	RFLI26G40GA	20111600107	20111600101	20111600111	.csv, .s2p

Table 6 Sequence of serial numbers and measurement files available, 3-band Q LO lines

4.2.2.2 3-band Q LO simulation's plots

Figure 22 and Figure 23 shows the gain and the output power at the end of the LO line, just before the LO input port of the mixer.

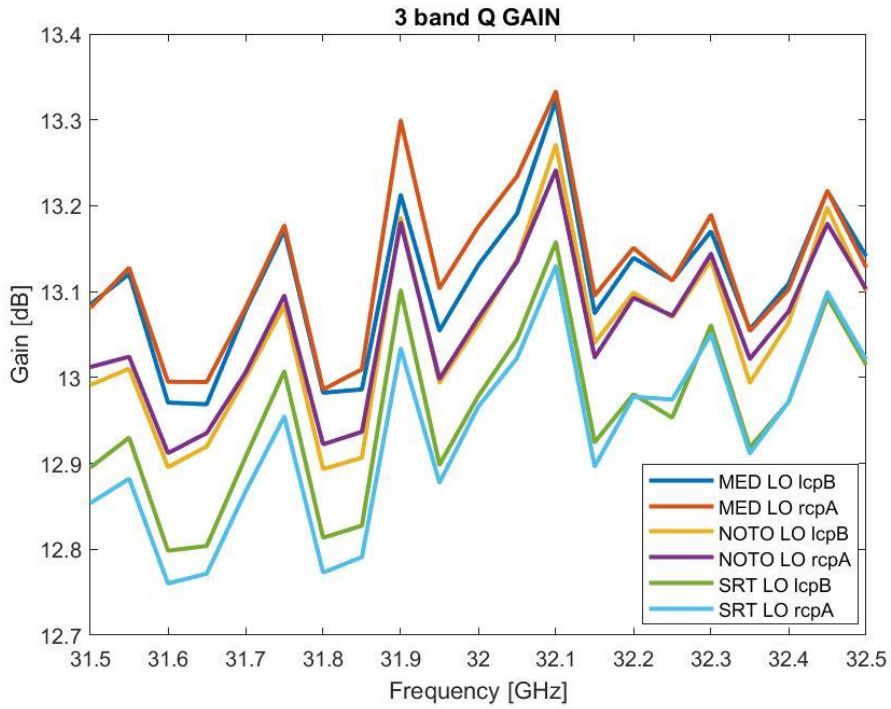

Figure 22 Gain simulations of the Q-band receivers LO line

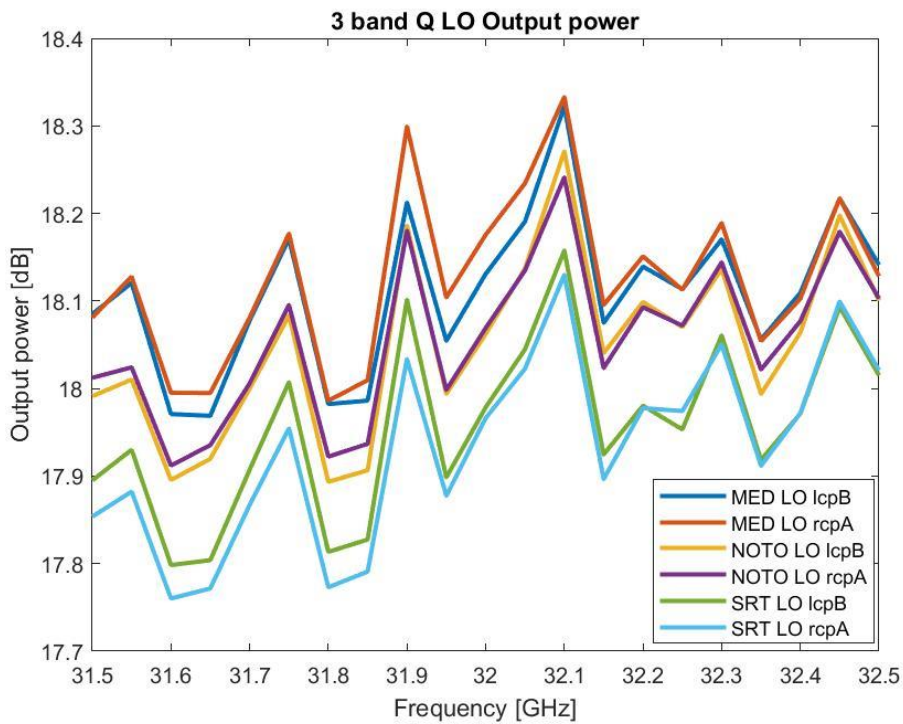

Figure 23 Output power simulations of the Q-band receivers LO line

4.2.2.3 Notes on the simulations

The expected input power at the mixer LO port must be between 11 and 20 dBm. The synthesizer power in the simulations is set to 5 dBm. In particular, the power levels are within the expected range.

4.3 3-BAND W RECEIVERS

Figure 24 shows the block diagram of the W-band receivers. Two different MATLAB project have been created: one for the lower frequency section (80-96 GHz) and one for the higher frequency section (100-116 GHz). For both these groups the simulations of RCP and LCP lines were performed.

Also for these receivers the two main lines (TE10 and TE01 as marked in the scheme) have different components, in particular some cables or waveguides.

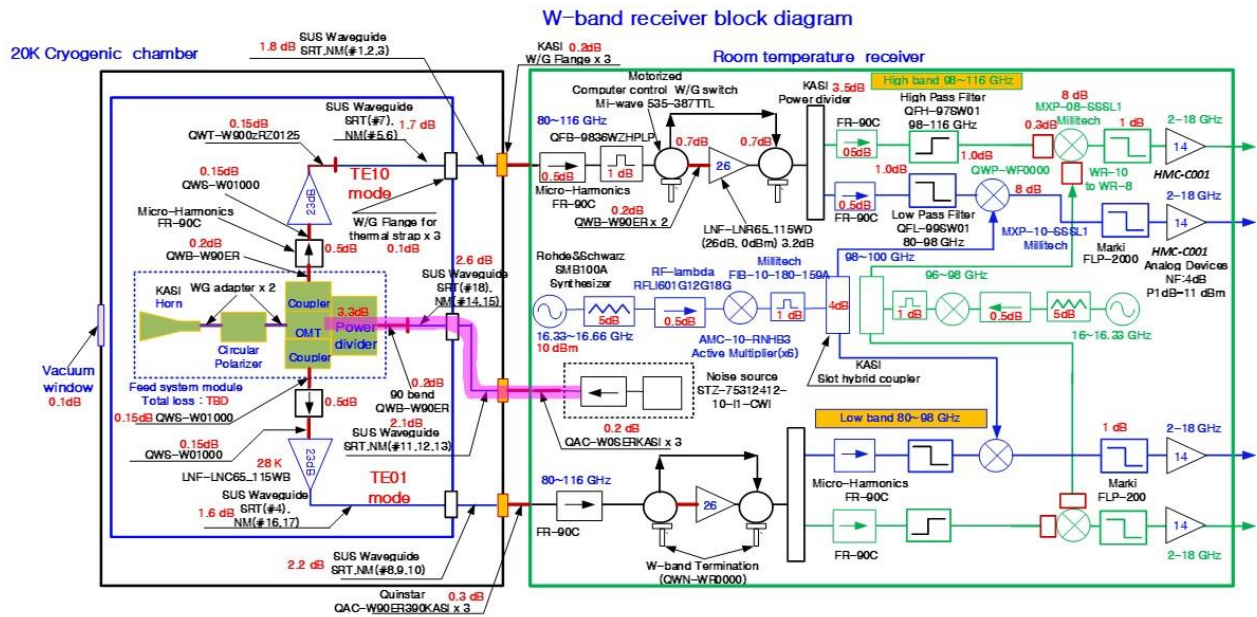

Figure 24 W-band receivers block diagram

4.3.1 Notes on the component measurement files included in the LCP and RCP simulations

The serial number of each component correspondent to each receivers line is reported in Table 7, taken from (Orfei A. , CTRs block diagram update & serial numbers, based on the revision by ST. Han, 2021). When not available, a random serial number was chosen for every component of the same type (and the corresponding measurement file) or a constant value of conversion loss (and noise figure). The constant value is usually taken from the receiver block diagram.

Component	Main RF chains W-band Model	SEQUENCE of SERIAL NUMBERS and CONVERSION LOSS (dB)						files used
		MED lcp(B)	MED rcp(A)	NOTO lcp(B)	NOTO rcp(A)	SRT lcp(B)	SRT rcp(A)	
QO		0.32 dB						-
Window		0.1 dB						-
Horn		0.2 dB						-
Polarizer		0.2 dB						-
OMT-Coupler		0.2dB						-
Waveguide	QWB-W90ER(TE10) QWS-W01000 (TE01)	0.2 dB (TE10), 0.15 (TE01)						-
Isolator cryo	FR-90C	No serial number available, considered sn026						.xls, .s2p
Waveguide	QWS-W01000	0.15 dB						-
LNA	LNF-LNC65_115WB	No serial number available, considered sn134						.txt
Waveguide	QWT-W900zRZ0125	0.15 dB (only TE10)						-
Waveguide		1.7 dB (TE10), 1.6 dB (TE01)						-
W/G Thermal strap	KASI	0.1 dB						-
Waveguide		1.8 dB (TE10), 2.2 dB (TE01)						-
W/G Vacuum Feedthru	KASI Brass with gold plate	0.2 dB						-
Cable	QAC-W90ER390KASI	0.3 dB						-
Isolator	FR-90C	0015	0017	0031	0030	0019	0023	.s2p and .pdf datasheet
RF Filter	KASI	No serial number, same .csv for every line						.csv
1st Switch	535-387TTL	0.5 dB						.s2p not considered
Termination	QWN-WR0000							
AMP	LNF-LNC65_115WD	129Z	141Z	130Z	138Z	127Z	126Z	.txt
2nd Switch	535-387TTL	0.5 dB						.s2p not considered
Termination	QWN-WR0000							
Power divider	KASI	4 dB constant value						-
Isolator (Low)	FR-90C	0033	0029	0022	0025	0016	0012	Used .s2p + interpolation from manufacturer pdf
Isolator (High)	FR-90C	0011	0032	0021	0028	0027	0018	Used .s2p + interpolation from manufacturer pdf
LPF filter	QFL-99SW01	14793-00005	00008	00007	00006	00003	300004	.csv, .s2p
HPF filter	QFH-97SW01	14792-00003	00004	00002	00005	00006	00007	.csv, .s2p
WR10toWR8	QWP-WF0000	No serial number available, 0.5 dB considered						-
Mixer W_{low}	MXP-10	3000	3002	3008	3007	3009	3001	Interp. from .pdf
Mixer W_{high}	MXP-08	3005	3010	3006	3009	3008	3007	Interp. from .pdf
IF Filter	FLP2000	No serial number available, considered sn01						.csv, .s2p
IF AMP (Low)	HMC-C001	2091	2105	2094	2107	2119	2096	.xls
IF AMP (High)	HMC-C001	2114	2104	2086	2093	2122	2087	.xls

Table 7 Sequence of serial numbers, files available or conversion loss/gain considered. 3-band W receivers

For the W band, as can be seen in Figure 24, no total loss for the Feed System Module is provided. Therefore, the losses of each single components (taken from Figure 24) was considered, with a total amount of that section (the Feed System Module) of about 0.8 dB.

The first isolator of each receiver is the sn26, regenerated and measured by KASI. For all the other isolators, values taken from the constructor measurements were considered because the KASI measurement were not consistent in the 110-116 GHz range.

The mixers conversion loss values were taken from an interpolation made from a .pdf measurement file. For the W/G switches 0.5 dB of conversion loss was considered, not 0.7 dB as in the block diagram. The values are set as constant since they don't change significantly in the band.

The QFB filters have been substituted with custom-made KASI filters. The conversion losses of these filters are lower than the QFB. They have been interpolated from a PDF measurement files and inserted in the simulations. The use of these new filters reduces the overall noise figure.

4.3.1.1 3-band W HF simulation plots

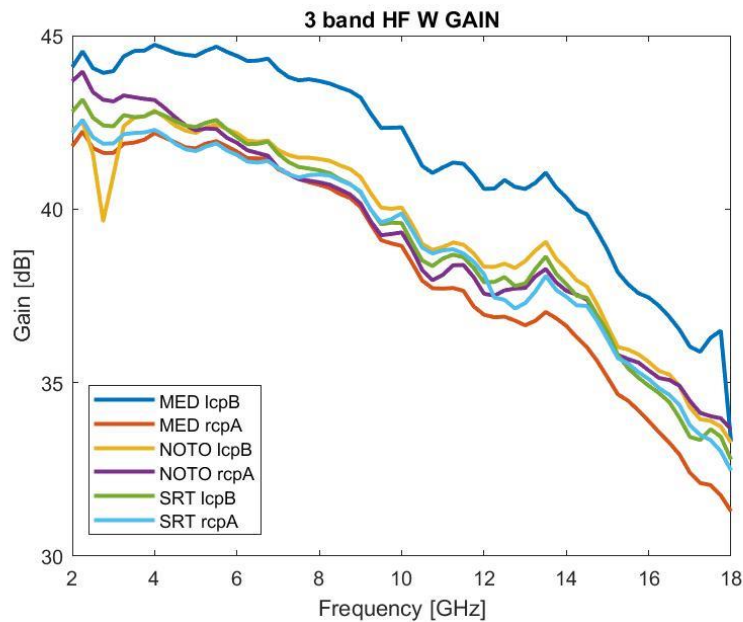

Figure 25 3-band W high frequency receivers gain

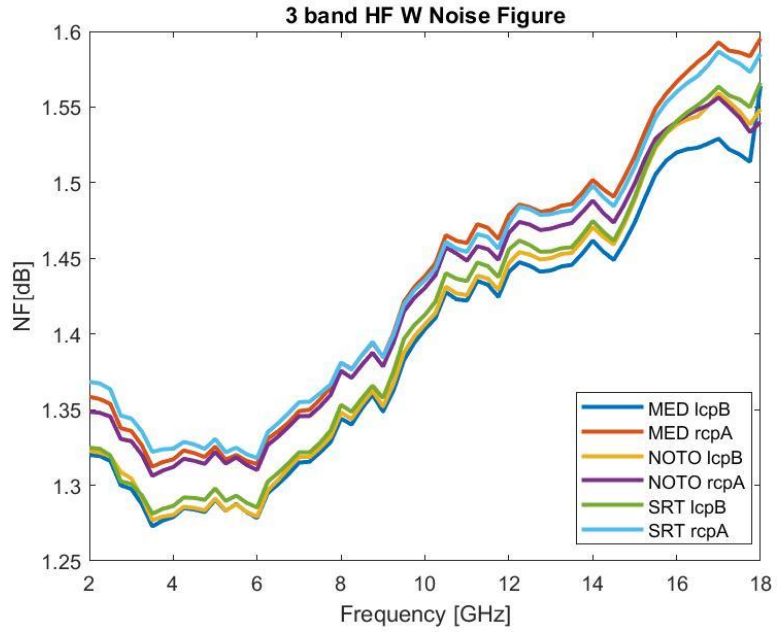

Figure 26 3-band W high frequency noise figure

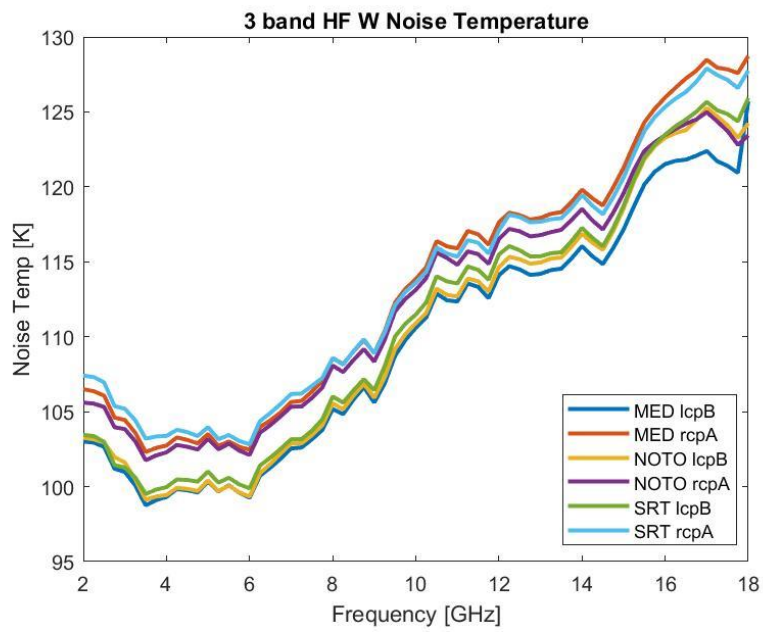

Figure 27 3-band W high frequency noise temperature

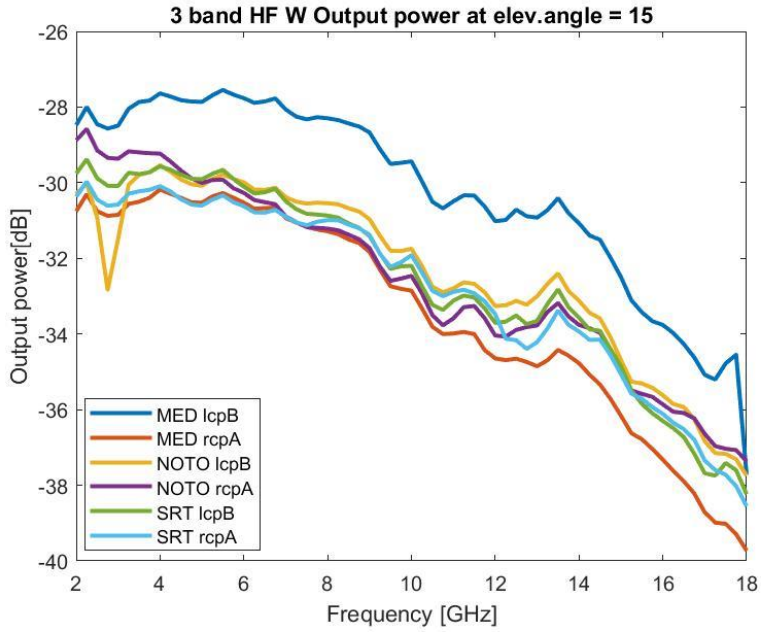

Figure 28 3-band W high frequency output power levels at 15° of elevation

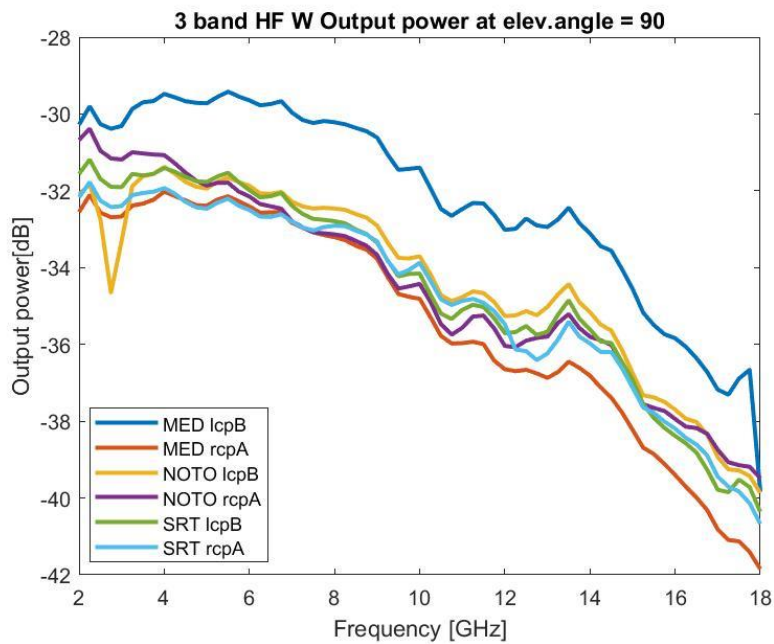

Figure 29 3-band W high frequency output power levels at 90° of elevation

4.3.1.2 Notes on the simulations

Medicina lcpB HF line has the best overall performance.

The Noto lcp line shows a notch at about 3 GHz IF, this is caused by the mounted LNA HMCC-001 sn2086 that requires a substitution.

The measured gain of the cryogenic LNAs are 2dB lower than the datasheet values.

Especially the noise figure is higher than the CDR estimated values: the main responsible are the losses of the connections between the 20 to 300 K stages of the cryostat and the warm section of the receiver. These are not sufficiently masked by the low gain of the cryogenic LNA.

4.3.1.3 3-band W HF sun simulations

The activation of a W/G switch in the W band excludes the LNF_LNR65_115WD amplifier in case of solar observations. Without this element the noise temperature of the receiver results about 1100 K. The sun temperature considered in the W band is 7000 K. The system temperature is about 8100 K. With these values the input power calculated and set in the simulations is -53.9 dBm.

Figure 30 and Figure 31 show the gain and the output power of the receiver in case of solar observations.

The output power estimation in case of solar observation in the W band are from -37.2 dBm (at 98 GHz) to -42 dBm (at 116 GHz). (KASI, 2020)

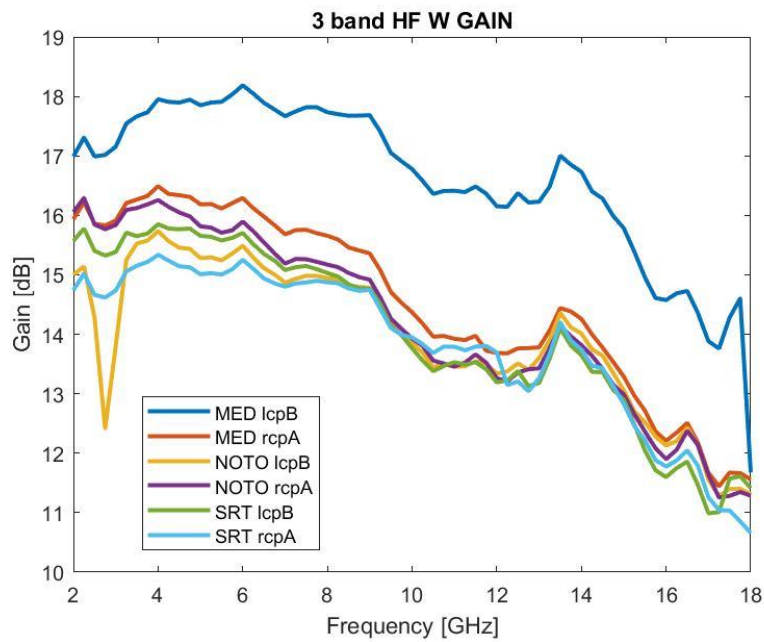

Figure 30 3-band W high freq. receiver gain in case of sun observation ($P_{in} \approx -53.9$ dBm)

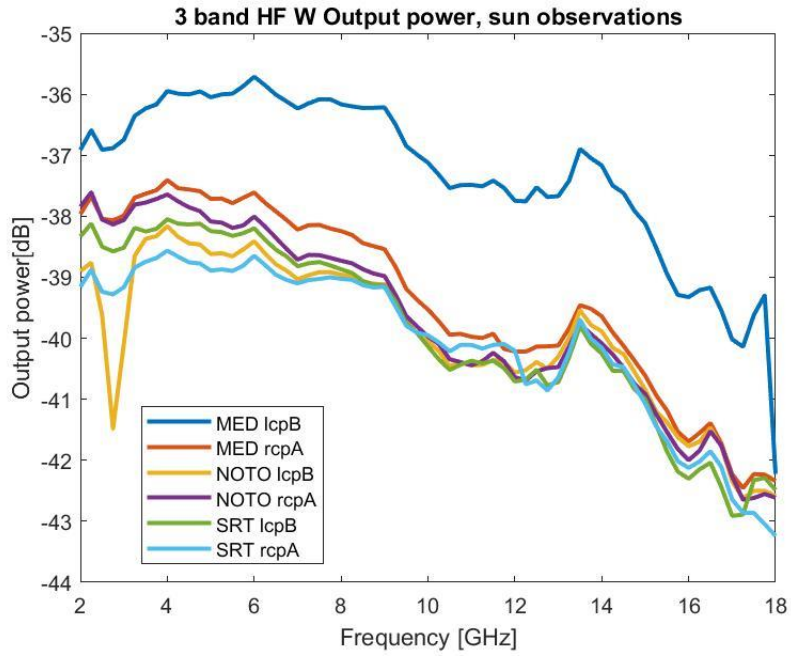

Figure 31 3-band W high freq. receiver output power in case of sun observation ($P_{in} \approx -53.9$ dBm)

4.3.1.4 3-band W LF simulation plots

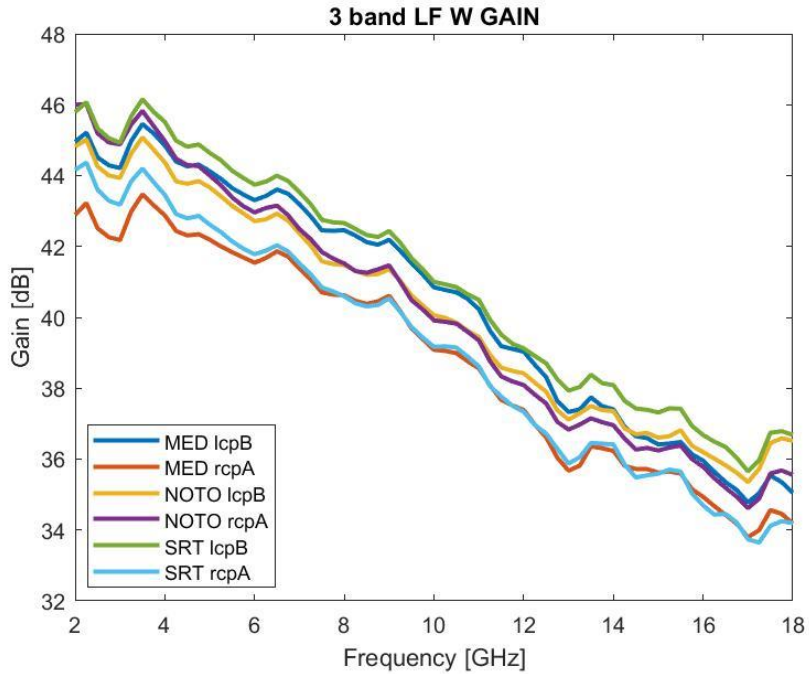

Figure 32 3-band W low frequency gain simulations

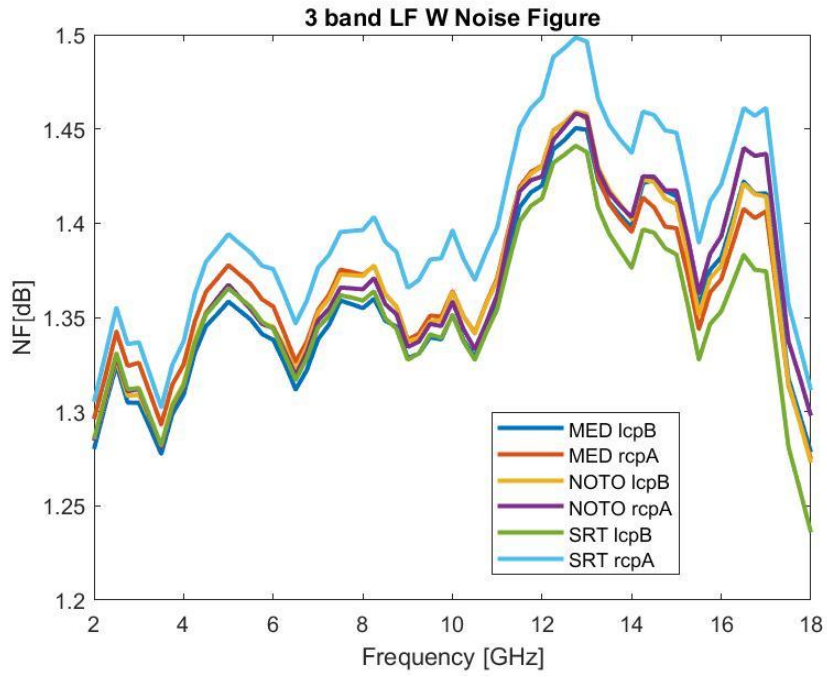

Figure 33 3-band W low frequency noise figure simulations

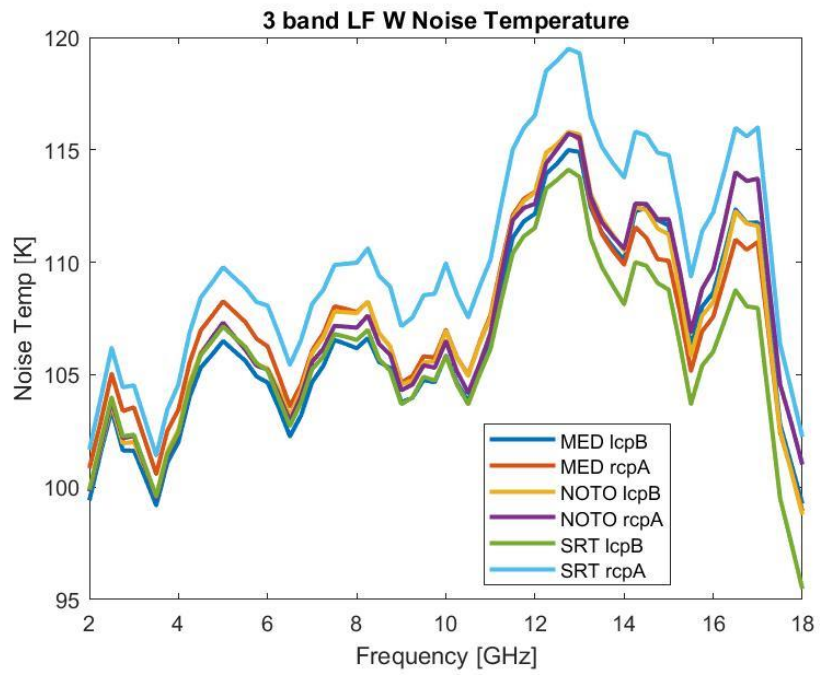

Figure 34 3-band W noise temperature

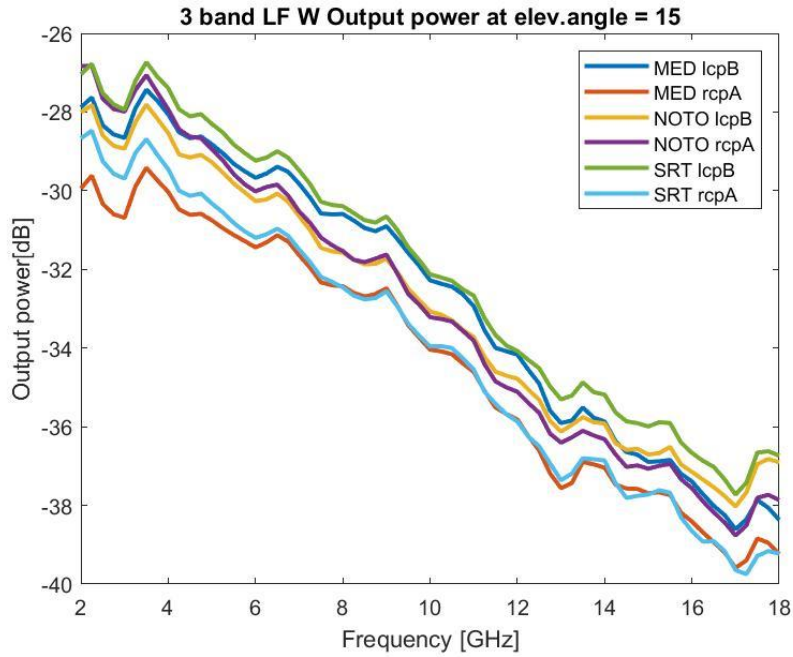

Figure 35 3-band W output power levels at 15° of elevation

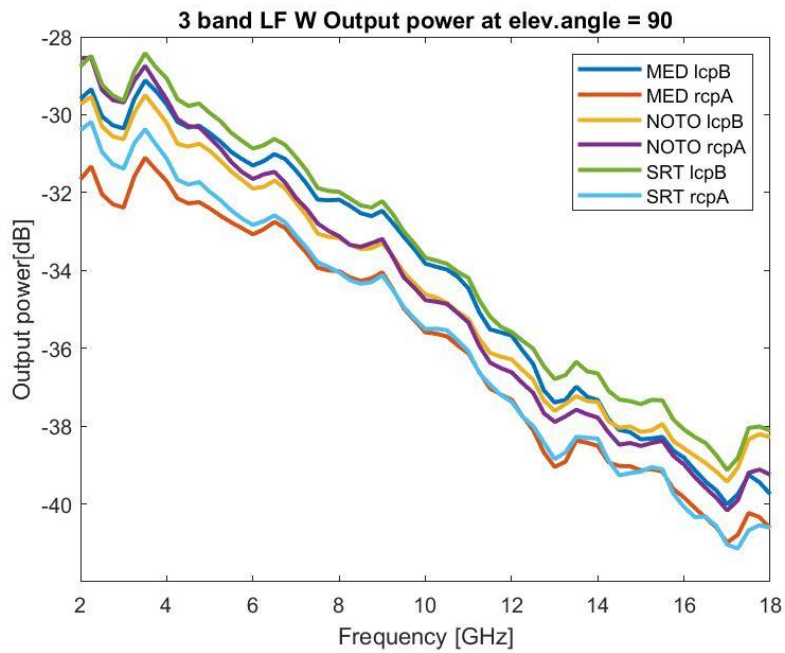

Figure 36 3-band W output power levels at 90° of elevation

4.3.1.5 Notes on the simulations

Please see also paragraph 4.3.1.2.

The noise figure and noise temperature are quite fluctuating functions. This can be caused by the oscillating values of the amplifiers noise temperatures. In the SRT rcpA receiver line the higher conversion losses isolators are installed (sn23 and sn29, with more than 1.2 dB of conversion loss respect of 0.7 of the others). The SRT rcpA noise figure can be the worst also for this reason.

4.3.1.6 3-band W LF sun simulations

The activation of a W/G switch in the W band excludes the LNF_LNR65_115WD amplifier in case of solar observations. Without this element the noise temperature of the receiver results about 1400 K. The sun temperature considered in the W band is 7000 K. The system temperature is about 8500 K. With these values the input power calculated and set in the simulations is -53.7 dBm.

Figure 37 and Figure 38 show the gain and the output power of the receiver in case of solar observations for the lower frequency lines of the W band receivers.

The output power estimation in case of solar observation in the W band are from -43.8 dBm (at 80 GHz) to -37.2 dBm (at 98 GHz). (KASI, 2020)

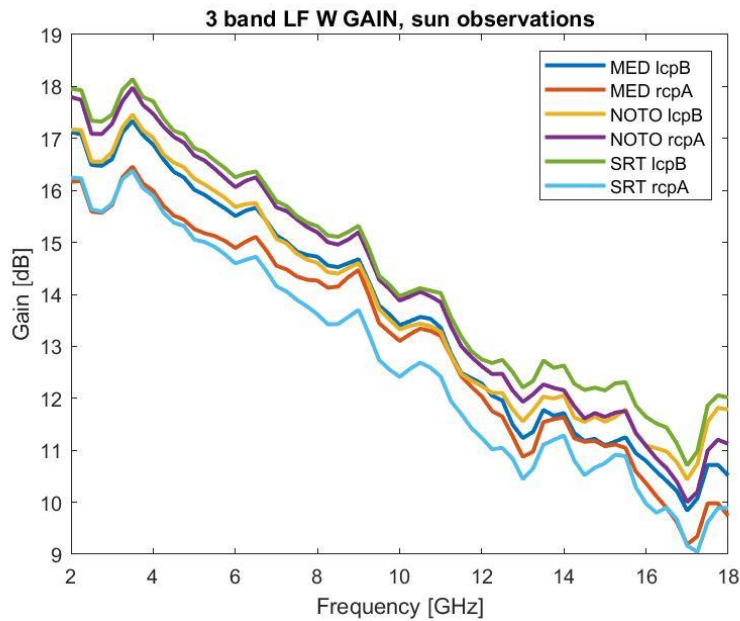

Figure 37 3-band W low freq. receiver gain in case of sun observation ($P_{in} \approx -53.7$ dBm)

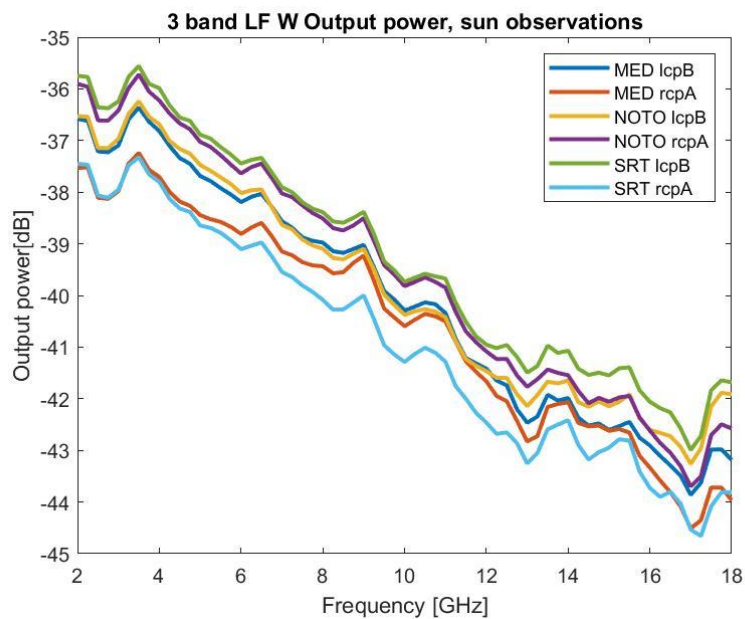

Figure 38 3-band W low freq. receiver output power in case of sun observation ($P_{in} \approx -53.7$ dBm)

4.3.2 3-band W LO line

4.3.2.1 Notes on the component measurement files included in the LO line simulations

The association between the serial number of the components and the receiver is reported in Table 8.

Component	LO chains W-band Model	SEQUENCE of SERIAL NUMBERS or CONVERSION LOSSES (dB)						Measurement file available and used
		MED LO (Low)	MED LO (High)	NOTO LO (Low)	NOTO LO (High)	SRT LO (Low)	SRT LO (High)	
Attenuator	Mini-circuit BW-K6- 2W44	5 dB						-
LO isolator before x6	RFLI601G1 2G18G	200707 00030	200707 00032	20070700 025	200707 00027	200707 00028	200707 00034	.csv, .s2p
LO x6 active multiplier	AMC-10- RNHB3	20.7 dB						Not considered
BPF for LO	FIB-10- 180159A	3007	3004	3002	3006	3006	3005	.s2p, .csv
LO Slot hybrid coupler	KASI	No serial number available, considered 4 dB						-
Termination	QWN- WR0000	0.5 dB						Not considered

Table 8 Sequence of serial numbers, file available or conversion loss/gain considered. 3-band W receivers, LO lines

The multiplier AMC-10-RNHB3 has only PDF measurement files and has quite constant values inside the considered band, for this reason constant values of parameters were set. Also for the termination a constant value was selected.

4.3.2.2 3-band W LO simulation plots

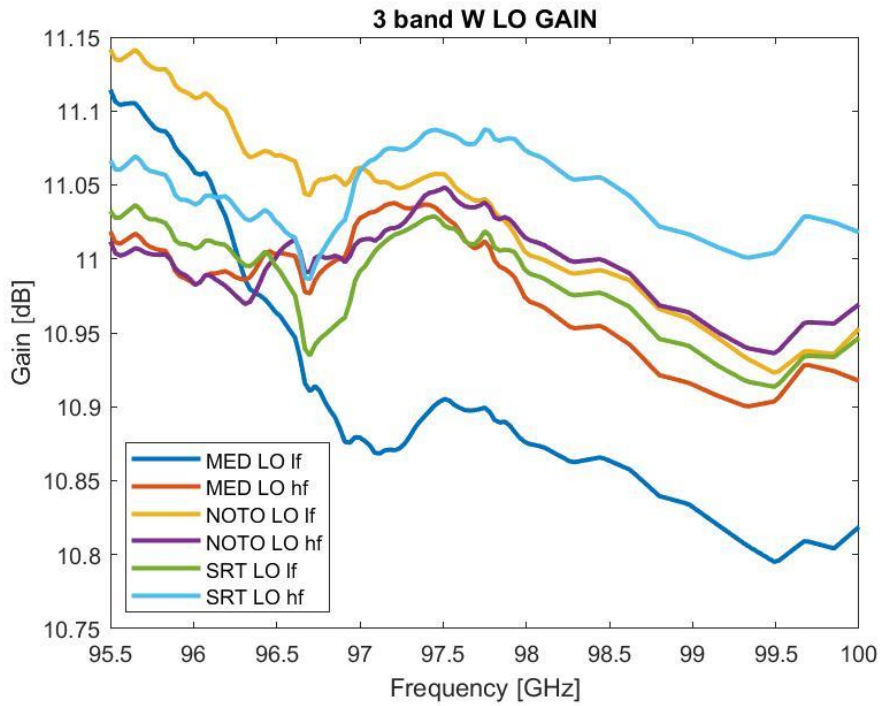

Figure 39 Gain of W-band LO lines

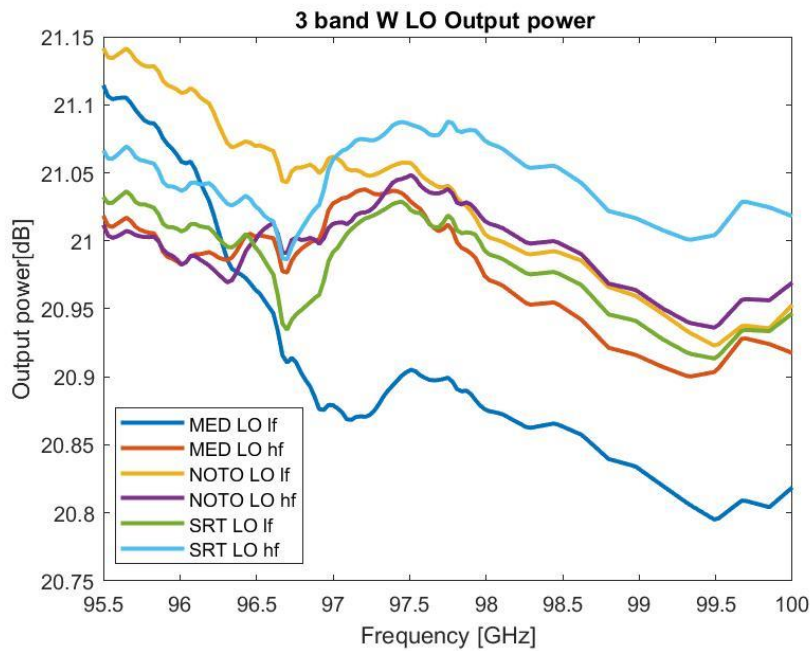

Figure 40 Output Power of W-band LO lines

4.3.2.3 Notes on the simulations

Figure 39 and Figure 40 show the gain and the output power of the LO lines of the W band receivers. The figures show both the high and low frequency lines. For the HF, the LO frequency is between 96 and 98 GHz while for the LF the LO frequency is between 98 and 100 GHz.

The output power is about 20 dBm. The input power at the LO port of the mixer is expected to be around 13 dBm both for MXP10 and MXP8 components. For these simulations the output power set in the synthesizer is 10 dBm, consequently the correct synthesizer power output level is 3 dBm.

4.4 RESULTS AND EVALUATIONS OF THE SIMULATIONS

Table 9 summarizes the main results of the simulations. The gain and the output power levels are expressed as the average values plus/minus the possible variations, the last have been calculated at two different elevations. The noise figure and noise temperature are expressed as the maximum (worst) reached value. The specifications included in the Statement of Work of the 3-band project are reported in the columns: Gain from spec., T_noise max from spec. and allowed output power levels.

Receiver	Gain ± ΔG [dB]	Gain from spec ± ΔG [dB]	NF max [dB]	T_noise max [K]	T_noise max from spec.[K]	Out Power 15°elev ± ΔP [dBm]	Out Power 90°elev ± ΔP [dBm]	Out Power allowed range [dBm]
K (18-26 GHz)	32.1±3.1 (29 to 35.2)	35±4 (31 to 39)	0.83	61.5	60	-45±3 (-48 to -42)	-49±3 (-52 to -46)	-50 to -10
Q (34-50 GHz)	35±5 (30 to 40)	42±2 (40 to 44)	0.97	72	70	-37±4 (-41 to -33)	-41±4 (-45 to -37)	-50 to -10
W (80-96 GHz)	40±6 (34 to 46)	43.5±4 (39.5 to 47.5)	1.5	119	100	-33±6 (-39 to -27)	-34.5±6.5 (-40.5 to -28.5)	-50 to -10
W (100-116 GHz)	38±7 (31 to 45)		1.6	129		-34±6 (-40 to -28)	-36±6 (-42 to -30)	

Table 9 Summary of the 3-band receivers simulations

All the simulations show a worsening of the performance of the receivers respect to the CDR declared values. Generally, it may be due to the following reasons:

- The introduction of new components not considered in the CDR (e.g. the cables and waveguides introduced in the cooled sections of the receivers. These components have quite high conversion losses)
- The higher losses and noise of the measured components respect to the values declared in the datasheets (e.g. this happens frequently for the cryogenic amplifiers)
- The low gain of the cryogenic amplifier for the W-band, resulting in poor masking of the noise of the subsequent chain

The worsening of the performances is more pronounced at higher frequency. The worst case is the W-band receivers for the higher frequency receiver lines.

For each receiver, the gains follow a monotonous trend.

- The comparison shows that the gains calculated are essentially complied in K-band, while the Q-band is not compliant, but this doesn't seem placing out of spec the max noise. The W-band is also not compliant and place out of spec the noise.
- The max noise is complied in K-, Q-, while W-band is outside specifications of 30%.
- The output power is complied at every band. This overcome the slight out of spec for Q-band.

On the basis of the results obtained Table 10 indicates the best and worst receiver (mainly in term of overall gain and NF in the whole band): in the case the results should be very similar, more than one receiver is indicated.

Receiver	Best receiver	Worst receiver
K (18-26 GHz)	Noto lcpB Med lcpB	SRT lcpB SRT lcpA
Q (34-50 GHz)	Med lcpB	SRT lcpB
W (80-96 GHz)	SRT lcpB	SRT rcpA
W (100-116 GHz)	Med lcpB	Med rcpA SRT rcpA

Table 10 3-band best and worst receivers for each band

The simulations of the sun observations case show values of output power inside the range estimated in the CDR for all the bands.

5 CONCLUSIONS

The MATLAB simulations of the 3-band receivers allow to evaluate their expected performances. In particular the gain, the output power, the noise figure and the noise temperature have been simulated. MATLAB calculates the receivers parameters using the Friis formulas, including also the mismatch calculation between the components by means of the insertion of .s2p S parameters files.

These calculations could be very similar to the reality because the files (.s2p, .csv or .xls of the gain, conversion losses and noise temperature) are the measurements of each component mounted in each receiver line. Really, not all components had its own measurement file. Moreover, some of them lack of the serial number, thus the link between the device mounted in the chain and its measure is lost. While these prevent a comprehensive simulation, on the other hand the amount of collected data was so big and careful to provide a credible view of the receivers performance, allowing MATLAB results to provide a comparison to be done at the time of the laboratory characterization of the 3-bands as well as possible improvement actions of CTRs.

APPENDIX A: COMPONENTS MEASUREMENT FILES

Most of the receivers components are equipped with measurement files. Hereafter some examples of measurement files are given.

.s2p measurement file

The following is an example of .s2p file of the filter FLP2000, sn3, for the Q band. In this case the S parameters are expressed in dB and phase. The frequency is in Hz.

```
!Agilent Technologies,N5245A,MY51251326,A.09.33.09
!Agilent N5245A: A.09.33.09
!Date: Thursday, February 04, 2021 09:36:52
!Correction: S11(Full 2 Port(1,2))
!S21(Full 2 Port(1,2))
!S12(Full 2 Port(1,2))
!S22(Full 2 Port(1,2))
!S2P File: Measurements: S11, S21, S12, S22:
# Hz S dB R 50
17890750000 -15.585978 -27.297407 -1.6451395 55.964073 -1.654129 55.766563 -14.574801 -44.636063
18023200000 -15.478209 -46.762867 -1.7099159 39.307964 -1.6862638 39.371536 -14.378766 -56.057438
18155650000 -14.920305 -67.50013 -1.7429533 22.834898 -1.7642854 22.850254 -13.763926 -67.046379
18288100000 -14.369716 -86.991241 -1.7753578 6.2132411 -1.7555118 6.3113503 -13.380874 -79.895569
18420550000 -14.221467 -106.73882 -1.8017417 -11.077591 -1.841749 -10.849423 -13.067324 -93.249947
18553000000 -13.939776 -126.66604 -1.8861477 -28.200836 -1.8746151 -28.273014 -12.838335 -105.7653
18685450000 -14.131713 -146.64113 -1.9038604 -46.107399 -1.9356258 -45.976051 -12.663404 -119.32708
18817900000 -14.11023 -167.6293 -1.9736065 -63.861252 -1.9457576 -63.999981 -12.490249 -133.10916
18950350000 -14.44985 170.76024 -2.0014665 -82.503769 -2.0378067 -82.387657 -12.308047 -145.1606
19082800000 -15.104384 146.17137 -2.10794 -101.1985 -2.0673816 -101.49925 -12.18867 -158.42123
19215250000 -16.346632 116.20854 -2.1514039 -120.99876 -2.1469922 -121.25165 -12.123603 -167.77188
19347700000 -17.766752 78.420204 -2.2653399 -141.70193 -2.2139885 -141.73686 -11.844096 -175.39345
19480150000 -18.436825 27.698418 -2.4216809 -163.25377 -2.4100339 -163.24312 -11.180004 176.83971
19612600000 -16.088596 -30.430874 -2.6866813 174.2299 -2.6446445 173.76585 -10.049698 169.80437
19745050000 -12.270204 -74.18959 -3.1816344 150.29425 -3.1135395 149.92509 -8.2620859 160.7894
19877500000 -9.0262804 -109.94268 -3.9437709 125.63047 -3.8995397 125.32679 -6.4614649 147.70251
20009950000 -6.5642042 -141.60309 -4.9328656 100.30982 -4.9528313 100.52209 -4.8519621 131.60907
20142400000 -4.7762594 -170.18288 -6.3139815 75.842018 -6.3086948 75.751106 -3.537179 113.89575
20274850000 -3.5394685 163.99226 -8.0605669 52.864246 -8.034935 52.412128 -2.6838293 95.676369
20407300000 -2.6859324 140.38458 -9.9628305 30.863098 -9.9681139 30.717823 -2.030786 78.349876
20539750000 -2.1711257 118.45913 -11.961027 10.84487 -11.94958 10.561826 -1.6182342 61.38623
20672200000 -1.7614224 98.714119 -13.979068 -7.4942484 -14.014895 -8.222023 -1.3294662 45.559856
20804650000 -1.5109071 80.653603 -16.026588 -24.944273 -16.085508 -25.039482 -1.1559535 30.867712
20937100000 -1.3171062 63.51466 -18.076435 -41.012646 -17.979221 -41.028564 -0.99228728 16.749191
21069550000 -1.1673845 47.43961 -20.213448 -56.269756 -19.973217 -55.450813 -0.87476468 3.3519959
21202000000 -1.0419652 32.223991 -22.143335 -70.310738 -22.030016 -69.677086 -0.80672783 -9.1162996
21334450000 -0.98972785 17.724174 -23.931564 -84.880394 -23.988388 -83.955147 -0.7665661 -21.148602
21466900000 -0.91724604 3.7752962 -26.048094 -97.191116 -25.845575 -97.424164 -0.69384921 -32.974983
21599350000 -0.86412305 -9.3523216 -27.734324 -110.4558 -27.633829 -108.60637 -0.65355957 -43.942261
21731800000 -0.78498834 -22.511719 -29.672619 -124.05921 -29.642063 -120.48711 -0.54602051 -54.894657
21864250000 -0.77859449 -34.553352 -31.462282 -134.73758 -31.23554 -135.83636 -0.58230692 -65.629181
```

21996700000 -0.67040205 -46.536736 -33.200603 -142.09612 -33.597389 -143.93436 -0.5009681 -75.75811
22129150000 -0.61810517 -58.129486 -34.665508 -151.74341 -34.773285 -157.905 -0.50154775 -85.858528
22261600000 -0.58281344 -69.168602 -36.170071 -164.77632 -36.309151 -165.13062 -0.48875338 -95.616631
22394050000 -0.60160059 -80.034592 -39.012638 -172.85802 -37.322647 -176.08163 -0.4656949 -104.82671
22526500000 -0.57007813 -90.593864 -40.553249 -173.98907 -39.636459 171.53888 -0.42455006 -114.13329
22658950000 -0.53724873 -100.81475 -42.645409 156.97435 -41.66185 164.3847 -0.41809848 -123.10252
22791400000 -0.53254193 -110.79153 -44.094688 147.91574 -42.423538 155.9193 -0.42522326 -131.93275
22923850000 -0.50116491 -120.35415 -45.283257 132.52788 -45.364006 144.90202 -0.40447012 -141.21297
23056300000 -0.45914266 -129.91727 -44.092648 138.13184 -47.410679 149.24916 -0.39051977 -149.40506
23188750000 -0.49348652 -139.36839 -46.605366 132.09171 -48.976078 121.18221 -0.37523356 -157.48643
23321200000 -0.51089221 -148.29694 -47.873447 128.4292 -51.532387 122.58747 -0.42399567 -166.05762
23453650000 -0.47540197 -157.09149 -50.238194 109.70434 -49.625019 107.99583 -0.43169427 -174.1292
23586100000 -0.47559333 -165.86269 -57.011906 97.468849 -51.048439 79.552887 -0.42902237 178.00438
23718550000 -0.49082521 -174.83603 -58.027962 129.78828 -54.350014 72.767014 -0.43098676 169.97571
23851000000 -0.47445938 176.94458 -51.052593 78.6409 -52.400822 96.036865 -0.42059267 162.30409
23983450000 -0.53323925 168.86299 -50.840572 72.368439 -57.130608 72.953896 -0.4555127 154.55122
24115900000 -0.45446318 160.37169 -53.395496 74.326355 -59.129253 64.492706 -0.42338279 147.05931
24248350000 -0.46607202 152.33643 -57.129581 56.904644 -56.119804 41.598709 -0.39880729 139.64165
24380800000 -0.50018233 144.2188 -59.44368 98.903725 -71.209274 55.978706 -0.44779089 132.23351
24513250000 -0.54680437 136.64859 -65.01107 37.766655 -59.726475 83.023506 -0.48604289 124.5607
24645700000 -0.5308013 128.73656 -72.221748 72.620293 -57.446865 -26.142778 -0.5145008 117.45647
24778150000 -0.53836805 120.92165 -58.036507 46.062477 -54.911816 -77.481392 -0.50566882 110.42676
24910600000 -0.50536001 113.1614 -59.90041 110.91999 -60.236237 126.4398 -0.53361881 102.97712
25043050000 -0.51142299 105.64697 -55.537163 53.197403 -54.968102 -28.45628 -0.50495887 96.020149
25175500000 -0.48392248 98.103989 -57.977394 151.64818 -60.110462 -80.038322 -0.50414336 89.137276
25307950000 -0.51678324 90.441154 -62.973995 89.095627 -63.45863 -63.321434 -0.51832771 82.039597
25440400000 -0.49917686 83.281059 -62.470966 -22.658043 -56.146584 27.678669 -0.52204257 74.893768
25572850000 -0.49646968 75.796371 -67.773354 -149.6633 -62.814484 -11.33226 -0.48580703 68.145416
25705300000 -0.48500353 68.740417 -56.077541 -107.65383 -61.003281 107.31374 -0.5067544 61.352921
25837750000 -0.44045219 61.457764 -63.069908 -38.415215 -64.538872 -62.363937 -0.49041316 54.478298
25970200000 -0.46738255 54.310841 -61.299763 -8.6580181 -79.479774 21.96686 -0.44029236 48.015995
26102650000 -0.4121069 47.230652 -63.923042 91.924583 -63.180763 11.62993 -0.41046846 40.825157
26235100000 -0.38730752 40.246567 -60.436958 -3.5936315 -72.230942 125.13148 -0.4415589 34.444206
26367550000 -0.42895415 33.038246 -64.587936 40.159103 -58.564396 -107.71964 -0.38635719 27.621546
26500000000 -0.34724838 26.459335 -64.948921 -152.09673 -62.133183 -24.943457 -0.37807429 21.144613

Example of a .csv measurement file.

The following is an example of a .csv measurement file of the QFB filter sn1445000001 for the Q band. It is reported only 2 GHz of scan.

```
Freq [GHz],"dB(S(Port1,Port1)) ["]","dB(S(Port2,Port1)) ["]"
34,-22.715496,-0.985858139999999
34.025,-23.424524,-0.9827879099999994
34.05,-24.110241,-0.9772697099999998
34.075,-24.85829,-0.9697048700000005
34.1,-25.470512,-0.9656344099999996
34.125,-26.08094,-0.9609813100000001
34.15,-26.456736,-0.9573369000000003
34.175,-26.784349,-0.9552051999999998
34.2,-26.931479,-0.9525364600000003
34.225,-26.807131,-0.9529113200000004
```

34.25,-26.691408,-0.94883162
34.275,-26.352884,-0.946528670000005
34.3,-25.99262,-0.947588150000001
34.325,-25.706226,-0.946808520000003
34.35,-25.477491,-0.946248769999997
34.375,-25.319326,-0.948526979999997
34.4,-25.263123,-0.943282659999996
34.425,-25.149872,-0.945207420000004
34.45,-25.183214,-0.945627209999996
34.475,-25.08066,-0.94122392
34.5,-25.13497,-0.93941569
34.525,-25.285393,-0.938551489999999
34.55,-25.510981,-0.935380339999995
34.575,-25.913763,-0.93472904
34.6,-26.33741,-0.933363380000003
34.625,-26.750469,-0.931881250000001
34.65,-27.175514,-0.93351102
34.675,-27.458868,-0.930972579999998
34.7,-27.665855,-0.930291950000002
34.725,-27.969893,-0.930190559999997
34.75,-28.071373,-0.92824692
34.775,-28.301506,-0.928568420000001
34.8,-28.410839,-0.926211060000002
34.825,-28.281322,-0.92549062
34.85,-28.035858,-0.927215699999998
34.875,-27.54916,-0.925564889999997
34.9,-26.973576,-0.926946999999999
34.925,-26.460115,-0.926131839999998
34.95,-25.927799,-0.930439530000001
34.975,-25.393385,-0.930089890000001
35,-25.008997,-0.93166876
35.025,-24.598337,-0.934695239999998
35.05,-24.340399,-0.935071889999999
35.075,-24.116625,-0.938780129999996
35.1,-23.785416,-0.939370450000004
35.125,-23.529251,-0.941450300000002
35.15,-23.215605,-0.942528840000004
35.175,-22.947374,-0.943865900000002
35.2,-22.760492,-0.946552750000004
35.225,-22.760887,-0.946859540000001
35.25,-22.836866,-0.947313249999999
35.275,-22.981693,-0.949867369999999
35.3,-23.079741,-0.95111549
35.325,-23.221661,-0.952865
35.35,-23.304377,-0.953442929999998
35.375,-23.438728,-0.954235909999998
35.4,-23.700176,-0.95307833
35.425,-24.021214,-0.952816550000002

35.45,-24.413534,-0.954878869999997
35.475,-24.748066,-0.952056590000001
35.5,-25.175764,-0.952194630000002
35.525,-25.603609,-0.955250500000001
35.55,-26.137142,-0.955379069999999
35.575,-26.66231,-0.954656419999998
35.6,-27.153896,-0.957799019999999
35.625,-27.585281,-0.957207079999997
35.65,-27.806826,-0.957533719999999
35.675,-28.211437,-0.960223670000002
35.7,-28.584351,-0.960498389999997
35.725,-29.031631,-0.959585610000001
35.75,-29.186758,-0.95923382
35.775,-29.202108,-0.963598250000002
35.8,-28.899994,-0.963815029999998
35.825,-28.5923,-0.965400339999999
35.85,-28.430943,-0.969348610000001
35.875,-28.15917,-0.970434309999999
35.9,-28.075262,-0.971505170000005
35.925,-27.778732,-0.974158999999996
35.95,-27.581175,-0.976959050000002
35.975,-27.476503,-0.980202499999996

Example of a .txt measurement file.

The following is an example of a .txt measurement file of the LNF-LNR65_115WD sn129 amplifier for the W band, where also the noise temperature is reported. It is taken from a screenshot of the file, just for the first measurement frequencies.

```

!Output loss file: DISABLED
!Sweep_index: 1
!DUT model number: LNF-LNR65_115WD
!DUT serial number: 129Z
!Station: RT1
!Setup: Room temperature
!Method: rt-noise
!Measurement end: 2020-12-06 14:45:32
!Measurement length [s]: 45.57352137565613
!Saved by LNF Software Version: 0.9.99
freq [Hz]      Gain [dB]      Te [K]      Gain_nfa_corr [dB]      Te_nfa_corr [K]      NF [dB]      Te_raw [K]      NF_raw [dB]      Phot      Phot_raw      Pcold      Pcold_raw      Tcold [K]
64500000000.0  24.594          382.755    24.594                382.755              3.65459    2617.74         10.0116    1678.66    6.78311     674.587    5.03601     296.5
65150000000.0  24.6285         422.124    24.6285               422.124              3.90158    434.75          3.9779     1431.08    1585.63     719.373    803.967     296.5
65800000000.0  26.0548         429.138    26.0548               429.138              3.94414    436.048         3.98567    2642.67    2717.43     1008.79    1043.41     296.5
66450000000.0  25.4452         453.404    25.4452               453.404              4.08827    461.561         4.13566    2326.86    2092.34     906.001    820.075     296.5
67100000000.0  26.0509         360.565    26.0509               360.565              3.50893    369.574         3.56865    3255.52    2940.98     912.64    832.567     296.5
67750000000.0  26.3727         378.987    26.3727               378.987              3.63019    388.509         3.69158    3083.19    2805.27     1010.38    927.982     296.5
68400000000.0  26.185          364.574    26.185                364.574              3.53561    370.176         3.57262    3244.18    4105.52     947.012    1205.62     296.5
69050000000.0  25.6191         374.591    25.6191               374.591              3.60157    380.784         3.64185    3443.67    4617.73     843.896    1139.47     296.5
69700000000.0  25.7956         349.525    25.7956               349.525              3.4346     357.313         3.48716    2844.23    3653.91     846.076    1096.11     296.5
70350000000.0  25.6262         397.921    25.6262               397.921              3.75141    406.314         3.80407    3233.05    4226.51     874.661    1153.48     296.5
71000000000.0  25.5585         370.664    25.5585               370.664              3.57582    376.402         3.61338    3319.33    5503.28     827.348    1380.54     296.5
71650000000.0  25.6005         359.309    25.6005               359.309              3.50053    363.779         3.53033    3023.56    5678.31     821.156    1549.79     296.5
72300000000.0  25.1376         400.049    25.1376               400.049              3.76482    405.356         3.79809    2892.48    5693.29     783.997    1551.7      296.5
72950000000.0  25.1213         366.24     25.1213               366.24               3.54665    371.489         3.58125    2633.94    5520.54     743.139    1566.4      296.5
73600000000.0  25.3171         339.084    25.3171               339.084              3.36311    343.168         3.39121    2610.43    5893.91     745.561    1691.07     296.5
74250000000.0  25.3457         342.464    25.3457               342.464              3.38638    345.789         3.40915    2972.85    6870.37     754.486    1750.41     296.5
74900000000.0  24.7052         328.373    24.7052               328.373              3.28853    332.055         3.31431    2198.71    5224.62     636.671    1519.19     296.5
75550000000.0  25.0086         332.259    25.0086               332.259              3.31573    337.565         3.35261    2112.41    3983.49     686.989    1302.85     296.5
76200000000.0  25.0229         330.794    25.0229               330.794              3.3055     337.67          3.35333    2523.34    4210.58     687.644    1156.56     296.5
76850000000.0  24.9261         325.694    24.9261               325.694              3.26967    331.694         3.31179    2770.35    4903.11     667.015    1189.14     296.5
77500000000.0  24.4358         316.209    24.4358               316.209              3.20225    320.697         3.23427    2011.53    4353.97     586.723    1276.54     296.5
78150000000.0  24.8803         303.578    24.8803               303.578              3.1108     307.416         3.13879    2188.91    4809.09     636.561    1404.87     296.5
78800000000.0  24.4563         315.021    24.4563               315.021              3.19372    319.38          3.2249     2385.62    5615.94     588.361    1392.47     296.5
79450000000.0  24.6236         305.541    24.6236               305.541              3.12513    310.327         3.1599     2354.96    5333.37     601.993    1371.41     296.5
80100000000.0  24.5225         306.961    24.5225               306.961              3.13548    311.443         3.16797    2008.5     4605.62     589.52     1358.88     296.5
80750000000.0  24.9775         310.602    24.9775               310.602              3.16188    314.204         3.18786    2400.42    5396.77     658.583    1487.03     296.5
81400000000.0  24.9072         295.798    24.9072               295.798              3.0535     298.816         3.07581    2272.15    5441.19     632.218    1519.55     296.5
82050000000.0  25.1647         329.748    25.1647               329.748              3.29817    332.973         3.32071    2146.4     4881.43     709.284    1618.64     296.5

```

BIBLIOGRAPHY

- Bolli, P. (2020). A compact triple band receiver system working at K-, Q- and W- band for Medicina, Noto and Sardinia Radio Telescopes. *RadioNet Conference*.
- Cortès, M. G. (2004). *Antenna noise temperature calculations*. SKA technical memo series.
- EIA IBIS Open Forum. (2002). *Touchstone file format specification*.
- KASI. (2020). *Critical Design Review for the compact triple band receiver system*.
- MathWorks. (2021). *RF budget analyzer*. Retrieved from https://it.mathworks.com/help/rf/rf-budget-analysis.html?s_tid=CRUX_lftnav.
- MathWorks. (2021). *RF Toolbox*. Retrieved from <https://it.mathworks.com/products/rftoolbox.html>.
- MathWorks, T. (2021). https://it.mathworks.com/help/rf/rf-budget-analysis.html?s_tid=CRUX_lftnav. Retrieved from RF budget analyzer.
- Orfei, A. (2006). *Indagine sui siti di Medicina e Noto per il loro utilizzo nella banda 90 GHz*.
- Orfei, A. (2019). *Nuovo sistema ricevitori e back-end a SRT*.
- Orfei, A. (2021). *CTRs block diagram update & serial numbers, based on the revision by ST. Han*.