



<b>Publication Year</b>	2022
<b>Acceptance in OA</b>	2023-02-08T09:22:54Z
<b>Title</b>	ASTRI Mini-Array Top Level Software Architecture
<b>Authors</b>	BULGARELLI, ANDREA, SCHWARZ, Joseph Hilary, TOSTI, Gino, COSTA, Alessandro, LUCARELLI, Fabrizio, MACCARONE, MARIA CONCETTA, CONFORTI, Vito, SCIACCA, Eva, GIANOTTI, Fulvio, SANGIORGI, Pierluca, GALLOZZI, Stefano, PARMIGGIANI, Nicolo', ZAMPIERI, Luca, BIGONGIARI, Ciro, GERMANI, STEFANO, LOMBARDI, Saverio, VERCELLONE, STEFANO, SCUDERI, Salvo, CALANDUCCI, ANTONIO SALVATORE
<b>Handle</b>	<a href="http://hdl.handle.net/20.500.12386/33222">http://hdl.handle.net/20.500.12386/33222</a>
<b>Volume</b>	ASTRI-INAF-DES-2100-001

# ASTRI Mini-Array

## Top Level Software Architecture



Prepared by:	Name:	<i>Andrea Bulgarelli</i>	Signature:		Date:	Jun 18, 2021
Verified by:	Name:	<i>Gino Tosti</i>	Signature:		Date:	Jun 18, 2021
Approved by:	Name:	<i>Gino Tosti</i>	Signature:		Date:	Jun 18, 2021
Released by:	Name:	<i>Salvatore Scuderi</i>	Signature:		Date:	Jun 18, 2021



**ASTRI Mini-Array**  
Astrofisica con Specchi a Tecnologia Replicante Italiana



Code: ASTRI-INAF-DES-2100-001

Issue:

2.5

Date:

Jun 18, 2021

Page:

2/119

	Name
<b>Main Authors</b>	<i>Andrea Bulgarelli, Joseph Schwarz, Gino Tosti, Alessandro Costa, Fabrizio Lucarelli, Maria Concetta Maccarone, Vito Conforti, Eva Sciacca, Fulvio Gianotti, Pierluca Sangiorgi, Stefano Gallozzi, Nicolò Parmiggiani, Luca Zampieri</i>
<b>Contributing Authors</b>	<i>Ciro Bigongiari, Stefano Germani, Saverio Lombardi, Stefano Vercellone, Salvo Scuderi, Antonio Salvatore Calanducci</i>



## Table of Contents

<b>1. Introduction</b>	<b>8</b>
1.1. Purpose	9
1.2. Scope	9
1.3. Requirements specification	9
<b>2. Related Documents</b>	<b>10</b>
2.1. Applicable documents	10
2.2. Reference documents	10
<b>3. Architectural approach and context</b>	<b>11</b>
3.1. Architectural development approach	11
3.2. The ASTRI Mini-Array top level requirements	12
3.3. Mini-Array Sites	13
3.4. Mini-Array Software System context diagram	14
3.5. Definitions	15
3.5.1. Systems, Subsystems, Assemblies and Devices	15
3.5.2. Assembly state machine	19
3.5.3. System/subsystem state machine	20
3.5.4. Software components state machine	22
3.5.5. Faults, Failures, Alarms	23
3.6. The Mini-Array System Logical View	25
3.6.1. Telescope System	27
3.6.1.1. Telescope Local Control System	29
3.6.2. Environmental Monitoring System	31
3.6.3. Atmosphere Characterisation System	32
3.6.4. Array Calibration System	34
3.6.5. Site Infrastructure Systems	36
3.6.6. Safety and Security System	37
3.6.6.1. Integrated Safety System	38
3.6.6.2. Integrated Security System	38
3.6.7. ICT System	39
3.7. The Mini-Array System Physical view	40
3.7.1. Physical view of the Array Observing Site	40
3.7.2. Physical view of the ASTRI MA Data Center	43
3.8. Observing Cycle	45
3.8.1. Science User perspective	48
3.8.2. Maintenance perspective	48
3.8.3. Observation perspective	48
<b>4. Mini-Array Software System Overview</b>	<b>50</b>
4.1. ASTRI Mini-Array Software Main Systems	51
4.2. Operation of the MA software system	52
4.3. Telescope domain and science domain	55



<b>5. Software Architecture functional decomposition</b>	<b>56</b>
5.1. On-Site Startup Systems	56
5.2. Supervisory Control and Data Acquisition system (SCADA)	59
5.2.1. SCADA Context diagram	59
5.2.2. SCADA main concepts	60
5.2.3. Software Framework and Middleware	63
5.2.4. SCADA main functional requirements	63
5.2.5. SCADA architectural communication patterns	66
5.2.5.1. Communication pattern #1: identification of an assembly event with a control software/collector	66
5.2.5.2. Communication pattern #2: identification of an assembly alarm with a control software or a collector	67
5.2.5.3. Communication pattern #3: reading of error codes	68
5.2.6. SCADA System Logical View	69
5.2.7. Central Control System	72
5.2.8. Array Data Acquisition System	76
5.2.8.1. Cherenkov Camera Pre-processing	77
5.2.9. Online Observation Quality System	79
5.2.10. Logging System	81
5.2.11. Monitoring System	83
5.2.12. Alarm System	86
5.2.13. Operator Human Machine Interface	90
5.2.14. Telescope Control System	91
5.2.15. Environmental Monitoring System Collector	93
5.2.16. Atmosphere Characterisation Control System	94
5.2.17. Array Calibration Control System	96
5.3. Archive System	97
5.4. Data Processing System	100
5.4.1. Stereo Event Builder and off-line software array trigger	102
5.4.2. Cherenkov Data Pipeline	102
5.4.2.1. A-SciSoft	103
5.4.2.2. Cherenkov Data Calibration and Reconstruction	103
5.4.2.3. Cherenkov Data Selection	104
5.4.2.4. MC/LUT IRF Generation	105
5.4.2.5. Cherenkov Data Scientific Analysis	105
5.4.3. Intensity Interferometry Data Pipeline	106
5.4.3.1. Intensity Interferometry Data Reconstruction	106
5.4.3.2. Intensity Interferometry Data Scientific Analysis	106
5.5. Science Support System	108
5.6. Simulation System	110
<b>6. Deployment view</b>	<b>113</b>
6.1. ASTRI MA Deployment View in nominal phase	113
6.2. ASTRI MA Deployment View in AIV/SVP phases	114
<b>7. Constraints and quality requirements</b>	<b>115</b>



# ASTRI Mini-Array

Astrofisica con Specchi a Tecnologia Replicante Italiana



Code: ASTRI-INAF-DES-2100-001

Issue:

2.5



Date:

Jun 18, 2021

Page:

5/119



7.1. Uniformity Requirement: Adherence to Software Framework	115
7.2. System Software Tools and run-time environments requirements	115
7.3. Quality Attributes	116
7.3.1. Availability	116
7.3.2. Performance	116
7.3.3. Scalability	117
7.3.4. Portability	117
7.3.5. Maintainability	117
7.3.5.1. Testability	117
7.3.5.2. Modifiability	118

		<p align="center"><b>ASTRI Mini-Array</b> Astrofisica con Specchi a Tecnologia Replicante Italiana</p>					
	<b>Code:</b> ASTRI-INA-DES-2100-001	<b>Issue:</b>	2.5	<b>Date:</b>	Jun 18, 2021	<b>Page:</b>	6/119

## INDEX OF FIGURES & TABLES



Document History		
Version	Date	Modification
0.2	Sept 05, 2019	Version after f2f meeting in Bologna
0.4	Oct 12, 2019	
0.5	Oct 18, 2019	Added Monitoring System general description and functional requirements
1.0	Nov 05, 2019	First release version name: V1.0
1.1		PBS 1.0 review Discussion on experiment/observatory and observing project
1.3	Dec 10, 2019	Internal release for commenting
2.0	Dec, 23, 2019	Release for comments
2.1	Feb 3, 2020	Included comments from Giovanni Pareschi and Salvo Scuderi. Changes on Sect 4.1.3 and 4.1.4 of operation modes. Changes in Data Processing system sections
2.2	Apr 16, 2020	Release for review
2.3	Nov 9, 2020	Changes after the Concept Design Review.
2.4	Apr 9, 2021	Changes due to internal reviews and discussions
2.5	Jun 18, 2021	Changed [ASTRI-9.1.0.0-2056] to align with [AD12]. Added reading point concept.

		<b>ASTRI Mini-Array</b> Astrofisica con Specchi a Tecnologia Replicante Italiana					
	<b>Code:</b> ASTRI-INAF-DES-2100-001	<b>Issue:</b>	2.5	<b>Date:</b>	Jun 18, 2021	<b>Page:</b>	8/119

## 1. Introduction

The **ASTRI Mini-Array (MA)** is an INAF ground-based project to construct, deploy and operate a set of nine identical dual-mirror Cherenkov gamma-ray telescopes, and several other auxiliary equipment and infrastructures. The ASTRI Mini-Array scientific objective is to exploit the imaging atmospheric Cherenkov technique to measure the energy, direction and arrival time of gamma-ray photons arriving at the Earth from astrophysical sources. In the almost unexplored energy range 1-300 TeV this technique requires an array of optical telescopes ( $\sim 4$  m in diameter) at a site located at an altitude of  $> 2000$ m. The telescopes will have reflecting mirrors focusing the Cherenkov UV-optical light produced by atmospheric particle cascades (air-showers), initiated by the primary gamma-ray photons entering in the atmosphere, onto ultrafast (nanosecond timescale) cameras. Most of the collected data will come from the large number of charged primary cosmic-ray initiated air-showers, which will also be recorded, then appropriate data analysis methods will be employed to reduce the level of this background and allow an efficient detection of gamma-rays coming from astrophysical sources.

Besides the gamma-ray scientific program, the ASTRI Mini-Array will also perform:

- Stellar Hambury-Brown intensity interferometry: each of the telescopes of the ASTRI Mini-Array will be equipped with an intensity interferometry module. The Mini-Array layout with its very long baselines (hundreds of meters), will allow, in principle, to obtain angular resolutions down to 50 micro-arcsec. With this level of resolution, it will be possible to reveal details on the surface of bright stars and of their surrounding environment and to open new frontiers in some of the major topics in stellar astrophysics.
- Direct measurements of cosmic rays: 99% of the observable component of the Cherenkov light is hadronic in nature. Even if the main challenge in detecting gamma-rays is to distinguish them from the much higher background of hadronic Cosmic Rays, this background, recorded during normal gamma-ray observations, will be used to perform direct measurements and detailed studies of the Cosmic Rays themselves.



The ASTRI MA telescopes (including the Cherenkov Camera) are an updated version of the ASTRI-Horn Cherenkov Telescope operating at Serra La Nave (Catania, Italy) on Mount Etna.

The nine telescopes will be installed at the Teide Astronomical MA System, operated by the Instituto de Astrofisica de Canarias (IAC), on Mount Teide ( $\sim 2400$  m a.s.l.) in Tenerife (Canary Islands, Spain).

The ASTRI MA System will be operated by INAF on the basis of a host agreement with IAC.

The main scientific goal of the ASTRI Mini-Array is to perform high-energy ( $E > 1$  TeV) observations of galactic and extragalactic sources with a sensitivity better than that reachable by the other Imaging Atmospheric Cherenkov telescopes currently in operation (HESS, MAGIC, VERITAS). Furthermore, the Mini-Array will also perform Intensity Interferometry of a selected sample of bright sources.

The MA must be **operated remotely** and no human presence is foreseen on the site during observations. The ICT systems installed on-site must be optimized to reduce costs without, however, compromising security and safety operations and the integrity of the collected data. ASTRI MA will benefit from the high-speed networking connection already present at Teide to deliver all data to the Italian ASTRI MA Data Center, limiting the number of storage devices on-site to the resources needed to prevent any loss of data in case of emergency.

		<b>ASTRI Mini-Array</b> Astrofisica con Specchi a Tecnologia Replicante Italiana					
	<b>Code:</b> ASTRI-INAF-DES-2100-001	<b>Issue:</b>	2.5	<b>Date:</b>	Jun 18, 2021	<b>Page:</b>	9/119

## 1.1. Purpose

This document provides a comprehensive architectural overview of the **ASTRI Mini-Array Software system** (a.k.a **MA Software** or **MA Software System**), that manages observing projects, observation handling, array control and monitoring, data acquisition, archiving, processing and simulations of the Cherenkov and Intensity Interferometry observations, including science tools for the scientific exploitation of the ASTRI MA data. This document, using a number of different views, depicts different aspects of the Mini-Array software and describes the significant architectural decisions.

## 1.2. Scope

This document provides a unitary view of the Mini-Array Software system, and applies to all application- and domain-level software for the MA software project. This is a requirements document and a reference starting point for the ASTRI Mini-Array teams and external contractor(s) for the design and the development of the different MA software packages.

The general architecture presented here has been driven by the MA Top Level Use Cases [AD3] that contain a full description of the Use Case View (a representation of the main functionalities and workflows of the system from a user and system perspective). For this reason, this document does not include an explicit Use Case View of the system. The ASTRI MA Data Model [AD2] is another important input for this document. For fast reference, [AD1] provides glossary and abbreviations.

Data Model [AD2] and Top Level Use Cases [AD3] are applicable documents and shall be considered an integral part and a complement of the requirements listed in this document.

In this document, some colours are used:

- **blue bold**, for definitions;
- **black bold**, for main concepts, or name of systems or functional units;
- **green bold**, for roles covered by human actors.

Figures are an integral part of the document and are applicable even if a full description is not provided.

Missing details will be provided in the detailed design documents and in future updates of this document.

## 1.3. Requirements specification

To specify requirements the following convention has been adopted [AD8]:



ASTRI-[PBS ID]-[TYPEID | REQID]

where PBSID is a unique identifier derived from the PBS document [AD4].

TYPEID must be

- Environmental 1000
- Functional and performances 2000
- Design 3000
- Physical 4000
- Interface 5000
- Product Assurance 6000
- Verification 7000
- Package, Transportation and Handling 8000

REQID is a progressive number.

		<b>ASTRI Mini-Array</b> Astrofisica con Specchi a Tecnologia Replicante Italiana					
	<b>Code:</b> ASTRI-INAF-DES-2100-001	<b>Issue:</b> 2.5	<b>Date:</b> Jun 18, 2021	<b>Page:</b> 10/119			

## 2. Related Documents

### 2.1. Applicable documents

- [AD1] N. Parmiggiani et al., ASTRI MA Glossary, ASTRI-INAF-LIS-2100-001 , issue 2.5
- [AD2] A. Bulgarelli, G. Tosti, et al., ASTRI MA Data Model, ASTRI-INAF-DES-2100-003, issue 2.5
- [AD3] A. Bulgarelli, G. Tosti, et al., ASTRI MA Top Level Use Cases, ASTRI-INAF-SPE-2100-001, issue 2.5
- [AD4] ASTRI MA Software PBS, ASTRI-INAF-DES-2100-002, issue 2.5
- [AD5] Science with the ASTRI Mini-Array, draft
- [AD6] Mini-Array PBS, ASTRI-INAF-DES-2000-001, issue 1.8
- [AD7] ASTRI Mini-Array Environmental Conditions at Teide, ASTRI-INAF-SPE-2000-002, issue 1.1
- [AD8] ASTRI Mini-Array Requirements Management Plan ASTRI-INAF-PLA-2000-002, issue 1.0
- [AD9] ASTRI Mini-Array Software Quality Assurance Plan, ASTRI-INAF-PLA-3400-001, issue 1.0
- [AD10] ASTRI MA Software Engineering Management Plan: ASTRI-INAF-PLA-2100-001, issue 1.0
- [AD11] ASTRI Mini-Array Data & Documentation Management Plan, ASTRI-INAF-PLA-1000-003, issue 1.2
- [AD12] ASTRI-MA Operation Concept: ASTRI-INAF-DES-1000-001, issue 1.3

### 2.2. Reference documents

- [RD1] J. Schwarz, G. Chiozzi, P. Grosbol, H. Sommer, A. Farris, D. Muders, ALMA Project Software Architecture, ALMA-70.15.00.00.001-H-GEN, Version J, 2007-08-13
- [RD2] Saverio Lombardi, Lucio Angelo Antonelli, Ciro Bigongiari, Martina Cardillo, Fabrizio Lucarelli, Matteo Perri, Antonio Stamera, Francesco Visconti, "ASTRI data reduction software in the framework of the Cherenkov Telescope Array," Proc. SPIE 10707, Software and Cyberinfrastructure for Astronomy V, 107070R (6 July 2018); doi: 10.1117/12.2311293
- [RD3] <https://opcfoundation.org/license/gpl.html>
- [RD4] George, I. M. and Breedon, L., "The Calibration Database Users Guide," OGIP Calibration Memo CAL/GEN/94-002, 1996, [https://heasarc.gsfc.nasa.gov/docs/heasarc/caldb/docs/memos/cal\\_gen\\_94\\_002/users\\_guide.pdf](https://heasarc.gsfc.nasa.gov/docs/heasarc/caldb/docs/memos/cal_gen_94_002/users_guide.pdf)
- [RD5] Hillas, A., "Cherenkov light images of EAS produced by primary gamma," Proc. 19th ICRC, (1985).
- [RD7] ASTRI Horn ref
- [RD8] Heck D., et al., Report FZKA 6019 (1998) (<https://www.ikp.kit.edu/corsika/index.php>).
- [RD9] Bernlöhr K., Astroparticle Physics 30, 3, 149-158 (2008).
- [RD10] CCSDS Secretariat, "Reference Model For An Open Archival Information System (OAIS)". 2012.
- [RD11] ALMA Common Software (ACS) Documentation, (<https://confluence.alma.cl/display/ICTACS/ACS+Documentation>)
- [RD12] OPC-UA communication protocol
- [RD13] G. Tosti, ASTRI-Horn "Heritage": Telescope Control System, ASTRI-INAF-REP-9100-001
- [RD14] F. Russo, TELESCOPE CONTROL UNIT SOFTWARE DESCRIPTION, ASTRI-IR-INAF-3700-093
- [RD15] F. Russo, TELESCOPE HEALTH CONTROL UNIT SOFTWARE DESCRIPTION, ASTRI-IR-INAF-3700-094
- [RD16] F. Russo, DATA BASE QUERY TOOL MANUAL, ASTRI-MAN-INAF-3700-012
- [RD17] G. Tosti, Telescope Mechanical Structure Assembly Requirements Specifications, ASTRI-INAF-SPE-7100-001, issue 1.3, 19/12/2020
- [RD18] ESO Integrated Alarm System <https://github.com/IntegratedAlarmSystem-Group/IntegratedAlarmSystem-Group.github.io>
- [RD19] Integrated Alarm System for the ALMA Observatory Document Number: ESO-287159

### 3. Architectural approach and context

#### 3.1. Architectural development approach

The main objectives of the architecture are to present the organization of the software system, describe its structural elements and their behaviour, and compose these structures into larger subsystems.



The architecture describes the components, their responsibilities and interfaces, and their primary relationships and interactions.

The Architecture is defined looking at the system from different viewpoints and is then illustrated through different views (see Fig. 1):

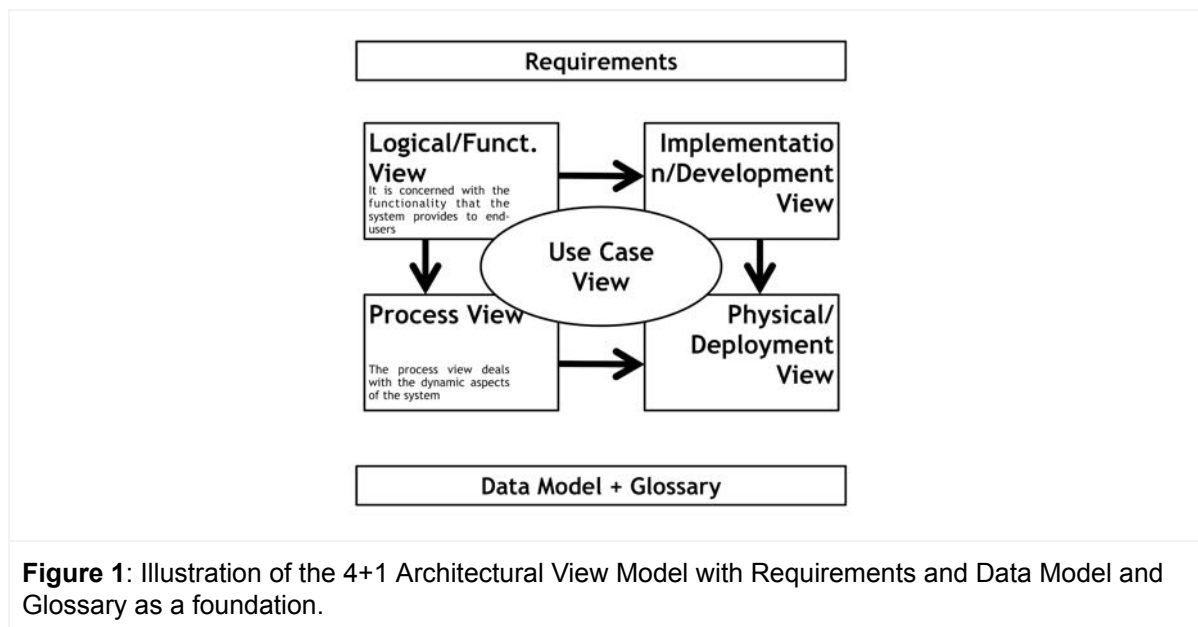
- 1) **Logical/Functional View:** a functional decomposition of the system with the description of the global information flow (based on the analysis of Use Cases and Data Models). UML diagrams are used to represent the logical view;
- 2) **Process View:** deals with the dynamic aspect of the system. Some activity, state and collaboration diagrams are present in this document;
- 3) **Implementation/Development View:** represents the detailed design of the implemented system. This view is outside the scope of this document and is not provided in this document.
- 4) **Physical/Deployment View:** The physical view depicts the system from a system engineer's point of view. It is concerned with the topology of software components on the physical layer as well as the physical connections between these components. This view is also known as the deployment view. Physical view is more concerned with the physical layer of the system, deployment view with the allocation of computing resources on physical nodes;
- 5) **Use Case View:** A use case is a list of actions or event steps typically defining the interactions between an actor and a system to achieve a goal. The actor can be a human or other system. In this context UCs specify directly functional requirements, and each UC constitutes a functional specification.



**Figure 1:** Illustration of the 4+1 Architectural View Model with Requirements and Data Model and Glossary as a foundation.



		<b>ASTRI Mini-Array</b> Astrofisica con Specchi a Tecnologia Replicante Italiana					
	Code: ASTRI-INAF-DES-2100-001	Issue:	2.5	Date:	Jun 18, 2021	Page:	12/119

This document covers functional and logical views; the Use Cases View is given in [AD3]. Glossary in [AD1], and the Data Model in [AD2] complements the information.

### 3.2. The ASTRI Mini-Array top level requirements

In order to reduce overall operation cost and manpower the following top level requirements were considered in preparation of this document:

1. The MA system shall carry out dedicated science programs defined by the MA Science Team.
2. The MA shall be located at the Teide Astronomical Observatory (Canary Islands) site.
3. There shall be no human presence at the site during the observing nights.
4. The MA shall have the capability to be operated remotely after the completion of the construction and commissioning phases.
5. The MA shall be operated from the Array Operation Centers (AOCs) available from different locations, including one at the Array Observing Site.
6. Only one AOC shall control the array, while any others shall be restricted to a read-only mode, suitable for monitoring.
7. All users of the MA Software System shall be members of the ASTRI Collaboration.
8. The scientific targets to be observed during the night shall be defined by the MA Science Team based on their visibility and the priority assigned to each science program.
9. The ASTRI MA observation plan shall be prepared and validated in advance by the Support Astronomer (SA) and the Astronomer on-duty, with the help of suitable s/w tools.
10. The ToO should be selected and prepared by the Astronomer on-duty.
11. The MA Software System shall be able to automatically execute the whole sequence of operations needed to perform an observation.
12. Only a quick-look of data at single Cherenkov Camera level shall be possible on-site.
13. The MA Software System shall be able to react to environmental critical and survival conditions in an automatic way to put the array system in *safe state*.
14. The amount of data storage installed at the observing site shall be adequate to guarantee no loss of technical and scientific data in case of lack of connection to the wide-area network. In particular, the on-site storage shall have the capability to maintain for at least 7 days: scientific RAW data; monitoring, logging and alarm data; data and data products of the online observation quality system (OOQS).
15. All data (scientific and technical) shall be transferred to the remote data center located in Rome (Italy) at the end of each run, where they will be permanently archived.
16. Any search for Cherenkov events detected in coincidence by more than one telescope (stereo trigger) shall be performed via software off-line at the Rome Data Center.
17. All data processing shall be carried out off-line at the Rome Data Center, including the historical analysis of monitoring and logging data.
18. All highest-level data products, associated with Observing Projects, produced by the off-line data processing shall be validated, archived, and made accessible to the MA Science Team.
19. The MA Science Team shall provide dedicated science tools for the scientific exploitation of the ASTRI MA data.
20. The MA Software System shall re-use when possible the control software of the devices already developed by the ASTRI Team for the ASTRI-Horn project.
21. The MA Software System shall be designed taking into account, when appropriate, the large availability of design and open-source software solutions to several concerns that are common to many other astronomical projects such as CTA, ALMA, SKA, LSST, TMT and EELT.

		<b>ASTRI Mini-Array</b> Astrofisica con Specchi a Tecnologia Replicante Italiana					
	<b>Code:</b> ASTRI-INAF-DES-2100-001	<b>Issue:</b>	2.5	<b>Date:</b>	Jun 18, 2021	<b>Page:</b>	13/119

22. The MA Software System shall be designed considering, when appropriate, the actual trends in the Big Data environment, adopting architecture solutions widely used in that context and avoiding custom solutions.
23. The MA Software System that shall be detailed designed or developed in house by the ASTRI-Mini-Array team shall be limited to specific domains.
24. All the MA software used during operation shall be open-source, governed by the Free Software Foundation's Lesser General Public License (LGPL), unless evaluation of a specific case shows purchase of proprietary software to be a more cost-effective solution to the given problem.
25. The ASTRI MA assembly/subsystem AIV activities shall be performed by dedicated AIV software tools connected to the Local Control Software of the assembly/subsystem and in compliance with the ASTRI Mini-Array AIV plans

These constraints have been taken into account in defining the software architecture presented in this document.

### 3.3. Mini-Array Sites

Fig. 2 shows the geographical locations of the Mini-Array main sites:

1. **Array Observing Site (AOS)** at Teide, where the telescopes and all Observing Site Subsystems are installed. The AOS includes an **on-site Data Center** (a.k.a. **AOS Data Center**) where all the computing and networking resources used by the on-site software system will be installed.
2. **Data Center** in Rome.

There are also **Array Operation Centers (AOCs)** (including **Control room**, or **CTRL room**) in different locations. The onsite AOC is located on the Themis Telescope Building at Teide and will be mainly used during AIV and SVP phases, and another at the IAC facilities in La Laguna (Tenerife). Other AOCs will be located at different remote locations (e.g. Italy). The **Control room** is a room serving as a space where the MA system can be monitored and controlled.

The **Operator** present at one AOC shall be responsible for supervising and carrying out scheduled observations and calibrations during the night, while the **Astronomer on-duty (AoD)** shall support and supervise the observations.

A physical view of the AOS and of the Data Center is shown in Sect. [3.7](#).

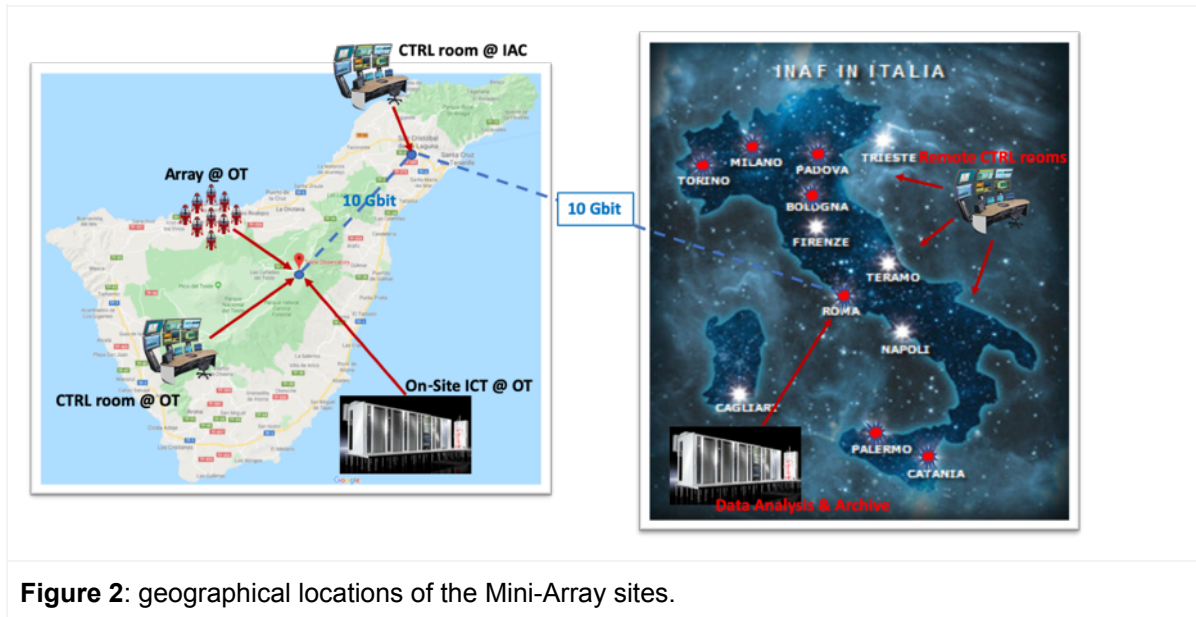

**Figure 2:** geographical locations of the Mini-Array sites.

### 3.4. Mini-Array Software System context diagram

Fig. 3 shows the context diagram of the **ASTRI Mini-Array Software system**. It defines the boundaries of hardware and software systems of the ASTRI Mini-Array project and identifies the flows of information between the MA and other external systems.

The definition of the users is given in [AD3]. **All users are part of the ASTRI Collaboration**. The user definitions are functional to illustrate the role of users likely to be concerned with a given software system described in this document.

The **Science User** is a member of the MA Science Team who will interact with the system to perform observations related to the Observing Projects and who will analyze science-ready data after the completion of the observations.

The **Operator** and **Astronomer on-duty (AoD)** conduct nightly operations.

In the diagram we show two other members of the ASTRI teams, the Maintenance Engineer and the Configuration Manager: 1) the **Maintenance Engineer** takes into account the possible behavior of the system to support predictive maintenance activities and to conduct on-site preventive and corrective maintenance tasks; and 2) the **Configuration Manager** to keep track of the configuration of the assets and of all its needed changes (e.g., when some system part is replaced).

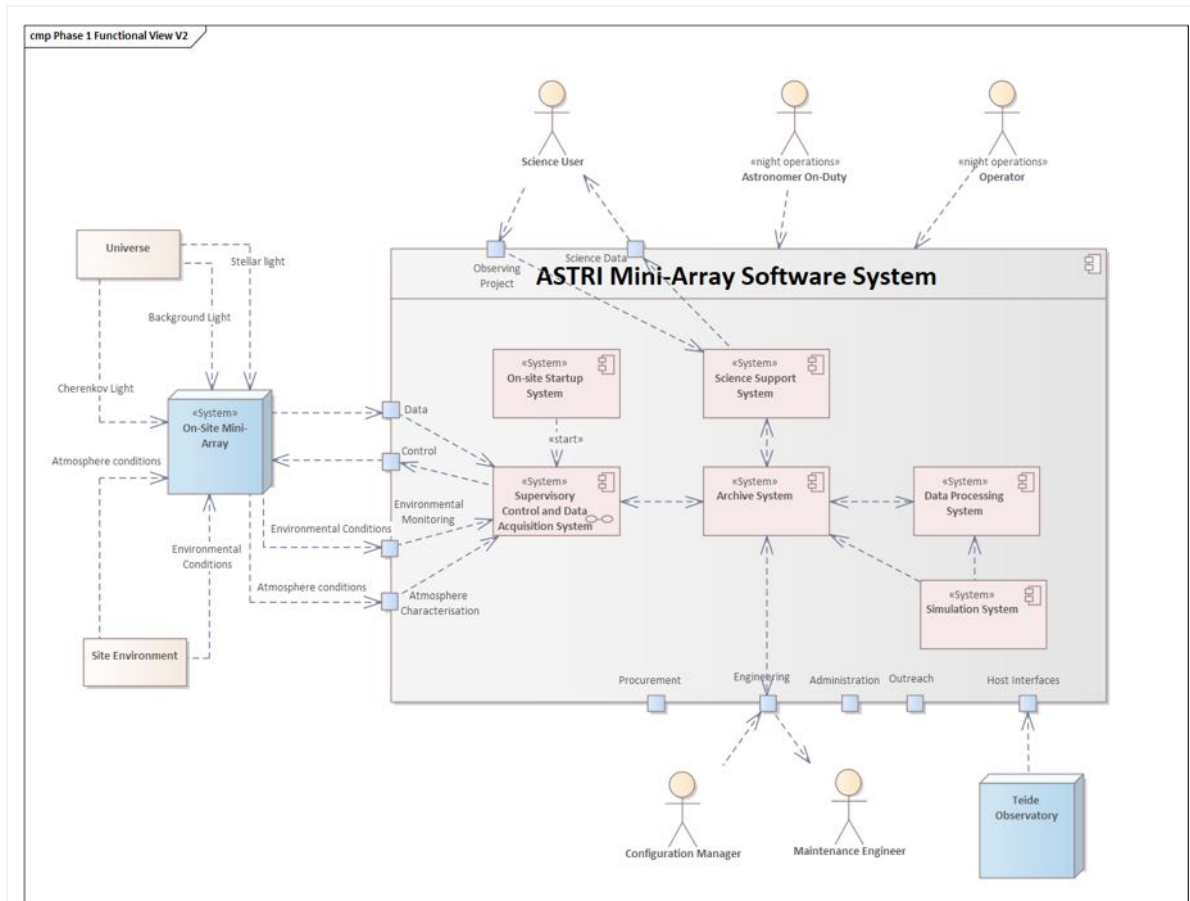

**Figure 3: Context diagram of the ASTRI Mini-Array Software System.**

## 3.5. Definitions

### 3.5.1. Systems, Subsystems, Assemblies and Devices



A **system** is an arrangement of parts that together exhibit behaviour or meaning that the individual constituents do not (INCOSE definition).

A **subsystem** is a system in its own right, except it normally will not provide a useful function on its own, it must be integrated with other subsystems (or systems) to make a system.

System and subsystem can be used indifferently and this depends on the level of description of the system.

Systems can be either physical or conceptual, or a combination of both.

**Components (or parts)** make up a subsystem or a system. These parts are assemblies and devices that form a hierarchy.

		<b>ASTRI Mini-Array</b> Astrofisica con Specchi a Tecnologia Replicante Italiana					
	<b>Code:</b> ASTRI-INAF-DES-2100-001	<b>Issue:</b>	2.5	<b>Date:</b>	Jun 18, 2021	<b>Page:</b>	16/119

The term **assembly** is used to indicate a hardware and software part of a subsystem.

The term **device** is used to indicate a part of an assembly.

An example can clarify better these concepts:

- System: ASTRI Mini-Array
- Subsystem: Telescope, LIDAR, Weather Station
- Assembly: Telescope Mount, Cherenkov Camera
- Device: Telescope Mount Drive system; Cherenkov Camera Lids

Systems, subsystems, assemblies and devices are **nodes** or **elements**.

A **port** is a software or logical interface of the **node/element**. A generic ports could be:

- CTRL: for control and command, including
  - Startup
  - Shutdown
  - Config: to configure the element;
- MON: for monitoring points, to collect the engineering data points of the element;
- Alarm: for alarms raised by the element;
- Status: to check the status of the element in terms of its internal state machine;
- ERR: error code provided by the element;
- Data: the data produced by the element, *e.g.*, scientific data from the Cherenkov camera, stellar intensity interferometry instrument, from atmosphere characterisation, or from environmental monitoring or atmosphere characterisation assemblies (see [AD2]);
- LOG: for logging data;

Additional connections of an element are power, network and timing (not represented in the diagram).

Fig. 4 shows the system, subsystem, assembly, devices hierarchy as nodes with ports.

Fig. 5 shows the system, subsystem, assembly, devices hierarchy as nodes and their relationship, with some related data models and control systems.

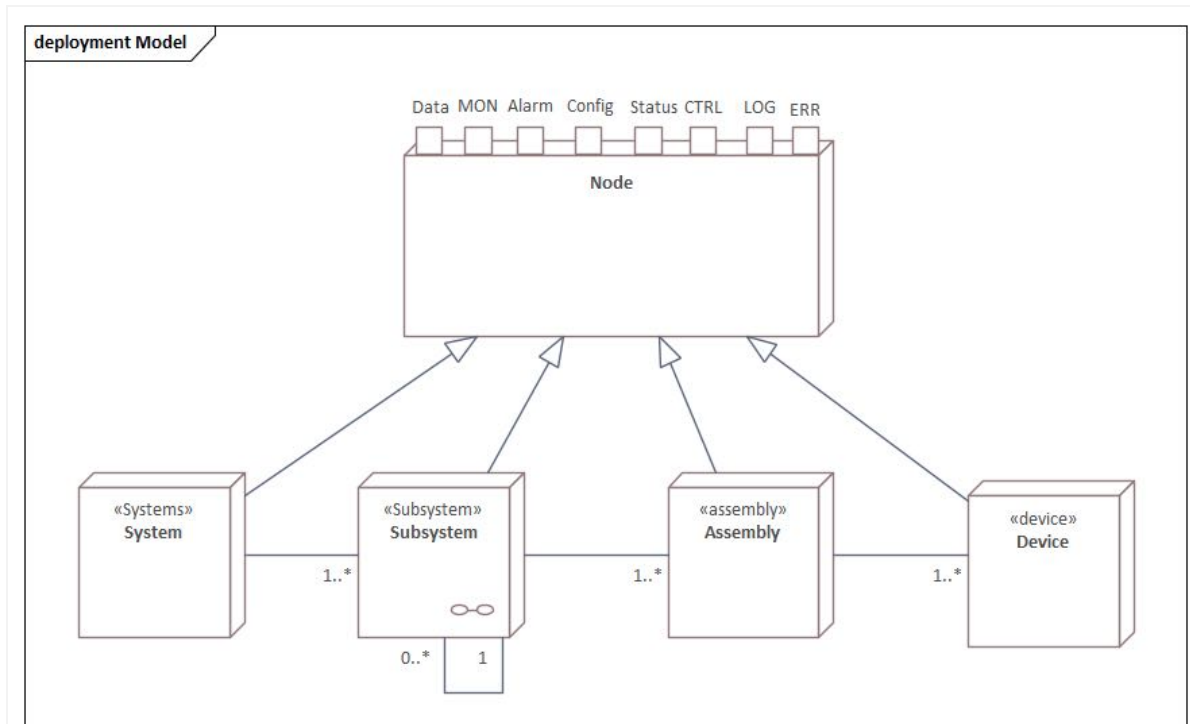

**Figure 4:** Systems, subsystems, assemblies, devices nodes hierarchy. A **port** is a software or logical interface of the **nodes/elements**.

All **software components** have the same ports of the nodes. This allows us to manage hardware and software with the same level of abstraction.

The **subsystems** installed at the observing site constitute the **Site System**. The Site Systems can be divided into **Observing Subsystems**, **Site Service Subsystems** and **Protection Subsystems**, with corresponding assemblies and devices. Details will be provided in [3.6](#).

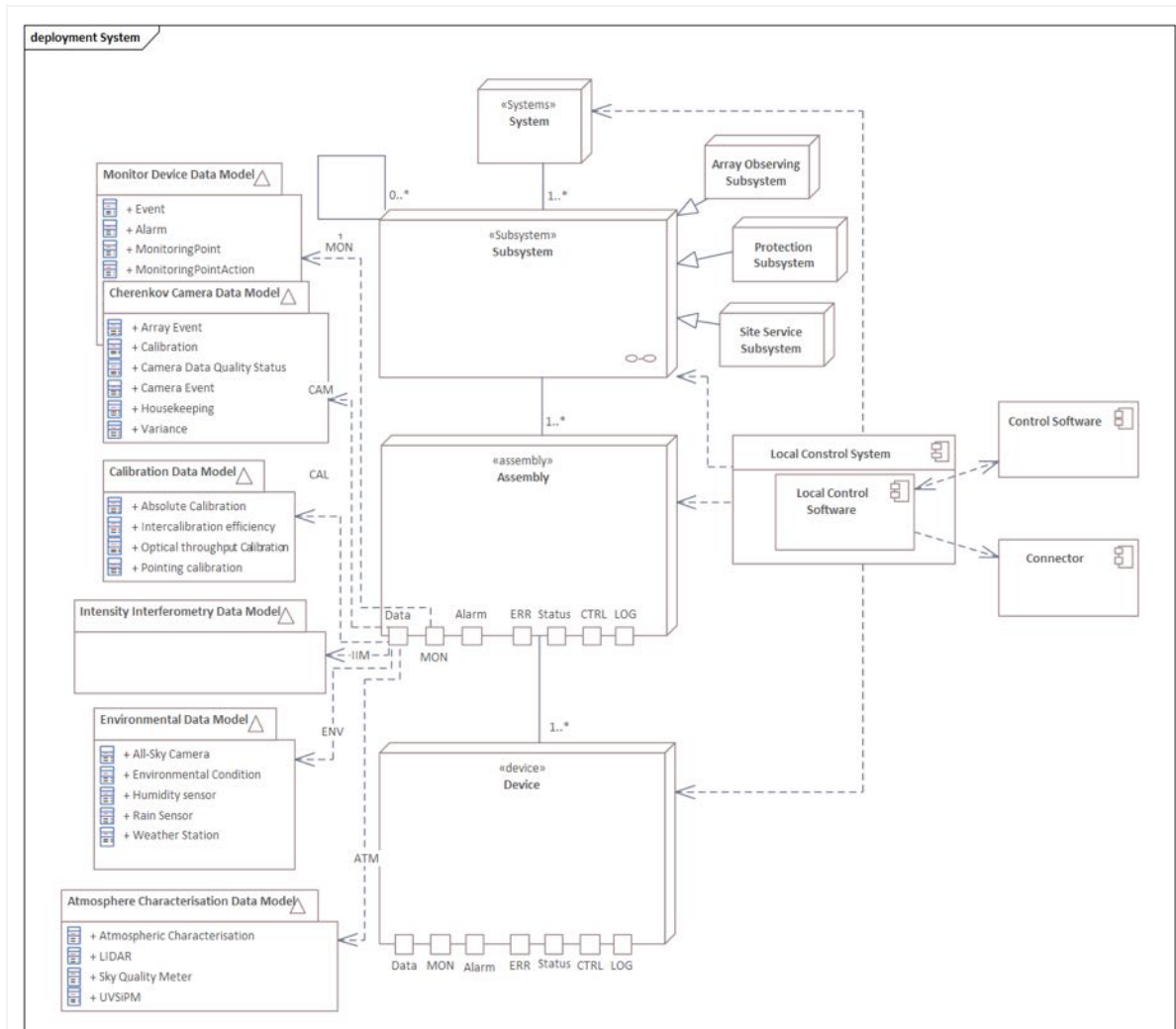

**Figure 5:** Systems, subsystems, assemblies, devices nodes, with Local Control Systems and Local Control Software and their relationships with some data models (see [AD2]) with their abbreviation used in the diagrams of this document. A Local Control Software has a server-side OPC-UA interface and is outside the SCADA system (see Sect. 5.2.).

Assemblies and/or subsystems have a **Local Control System**, *i.e.*, a hw/sw system used to switch-on/switch-off, control, configure and get the status, monitoring points and alarms of all parts of the system/assembly. The software part is called **Local Control Software**. The abbreviation LCS can indicate both the system or the software, and this depends on the context.

Each LCS could have its own **Local Engineering HMI**. Each Local Control Software shall implement a local state machine of the assembly/system.

In general, an assembly is a component of a subsystem that has a specific purpose, *e.g.*, the Telescope Mount System is an assembly of the Telescope subsystem with a Local Control System that commands the devices (it is composed of the devices that control the motion of the Azimuth and Elevation axes).

An **AIT/AIV Software** could be present and can be used for AIV/AIT activities and is connected with the **Local Control Software** via OPC-UA interface as a general rule. The **Local Engineering HMI** could be part of the **AIV/AIT Software**. Fig. 6 reports an example of interconnection and relationship between assemblies, Local Control Software, AIV/AIT Software and Local Engineering HMI.

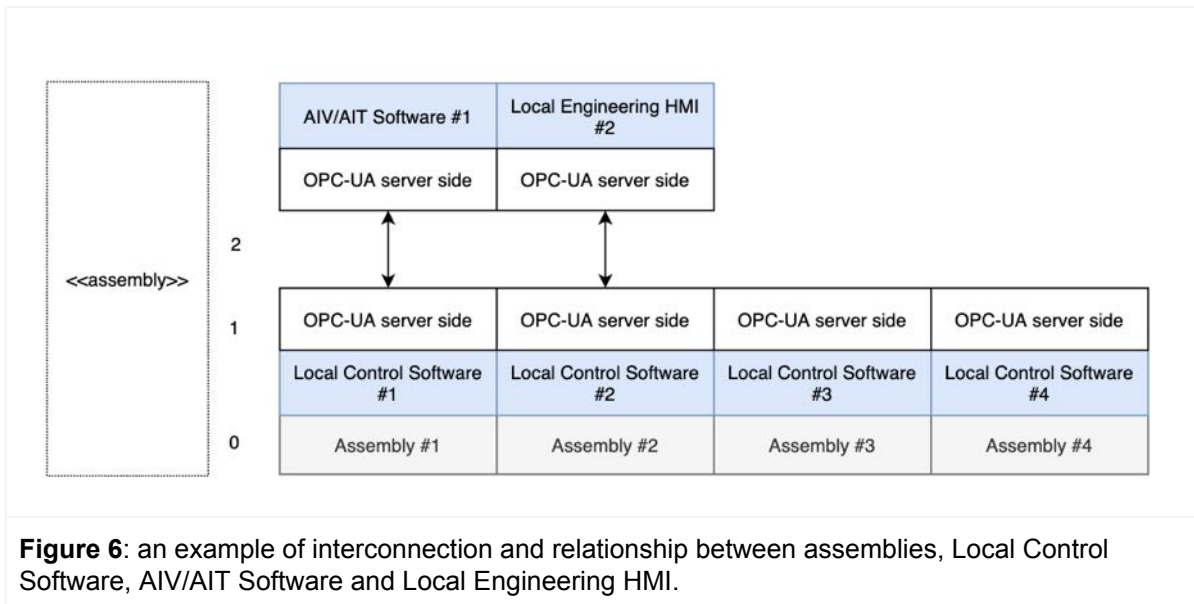

### 3.5.2. Assembly state machine

A **generic assembly/device state machine** is defined in Fig. 7. **Assembly states** are defined as follows:

- **Off State:** the assembly is entirely without electrical power.
- **On State:** with the following sub-states:
  - **Initialised State:** the state of the assembly after power on.
  - **Standby State:** a state that is still safe with respect to extreme conditions, but has all components activated, with preparations for observation initiated. The assembly is prepared for rapid entry into the Operational State.
  - **Operational State:** a state associated with operations (e.g. data taking), with configuration dictated by performance requirements. This state might not be applicable to some site services and protection assemblies. Two substates could be present:
    - **Nominal:** the assembly can be operated with full performance;
    - **Degraded:** the assembly can be operated with reduced performance.
  - **Safe State:** if dangerous conditions are present, the assembly goes into a configuration where the object is considered exposed to “normal” risk for damage or loss. This is also the configuration designed for survival in extreme conditions, minimising the use of power whilst still providing basic status monitoring, and maximizing instrument lifetime.
  - **Fault State:** the assembly has encountered a serious problem, which means it is currently unable to meet the requirements associated with one of the standard states. Alarm shall be generated. The transition to Fault State shall generate an alarm signal for the **Operator**.



- **Initialised State:** the state after the power is turned on. The system is also configured and in standby, i.e. the subsystem is prepared for rapid entry into the Operational State.
- **Operational State:** a state associated with data taking.
  - **Nominal:** a state in which the system can be operated with full performance. Substates of this state are foreseen and depends by the system.
  - **Degraded State:** a state in which the system can be operated with reduced performance. Substates of this state are foreseen and depends by the system.
- **Safe State:** if dangerous conditions are present, the system goes into a configuration suitable for survival in extreme conditions, minimising use of power whilst still providing status and vital monitoring information. The safe state configuration shall be defined for each system installed at the site
- **Fault State:** the subsystem has encountered a serious problem, which means it is currently unable to meet its functional and performance requirements. The transition to Fault State shall generate an alarm signal for the **Operator**.

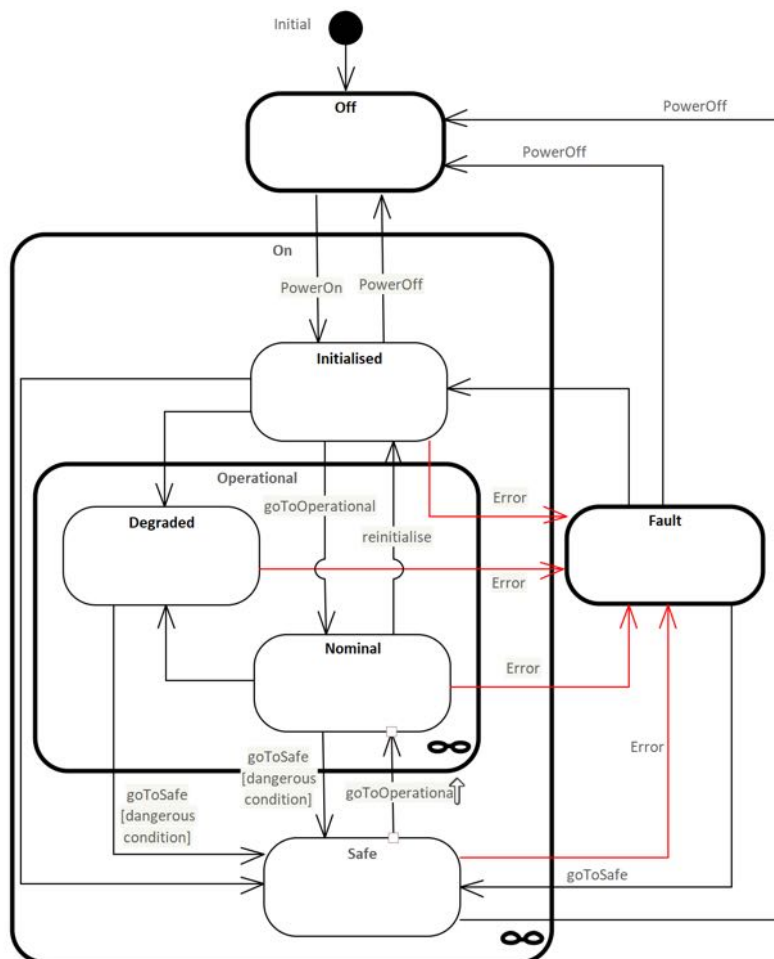
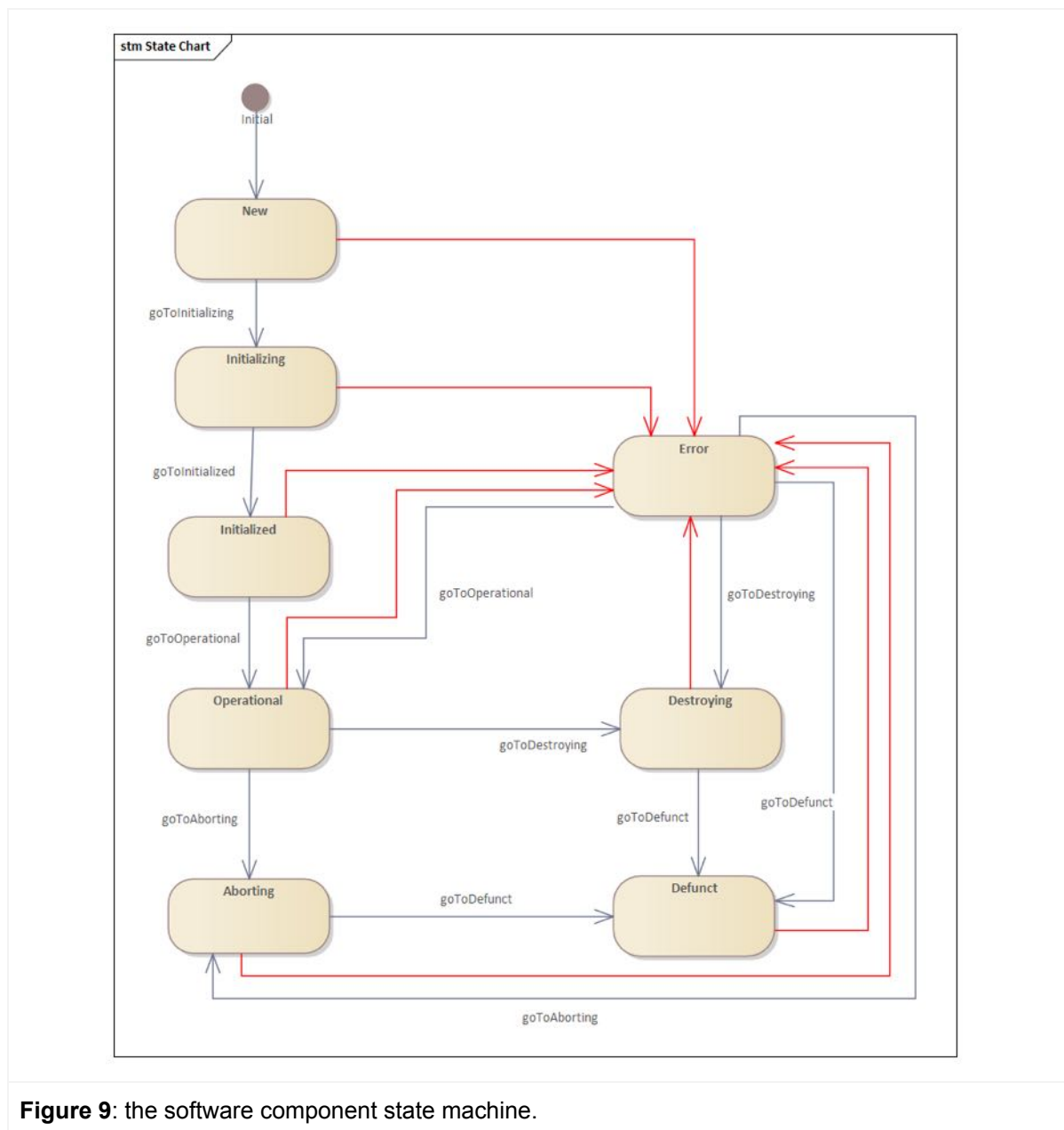

**Figure 8:** System/subsystem state machine.



### 3.5.4. Software components state machine

A **generic software component state machine** is defined in Fig. 9.

The component starts its lifecycle in the state New. During objects' life it cycles through following states in prescribed order: new, initializing, initialized, operational. Object lifecycle can be aborted anytime, abort sequence is aborting and defunct. There also exists an error state.



**Figure 9:** the software component state machine.

		<b>ASTRI Mini-Array</b> Astrofisica con Specchi a Tecnologia Replicante Italiana					
	<b>Code:</b> ASTRI-INAF-DES-2100-001	<b>Issue:</b>	2.5	<b>Date:</b>	Jun 18, 2021	<b>Page:</b>	23/119

### 3.5.5. Faults, Failures, Alarms

#### Fault and failures

- **Abnormal status:** a status that occurs in a process system when an operating variable (flow, pressure, temperature, etc.) ranges outside of its normal operating limits, i.e. when an abnormal condition occurs.
- **Abnormal conditions:** refers to measurements to indicate ranges outside the normal operating limits and that requires an action.
- **Fault** or **element malfunction:** any change in the state of an item which is considered anomalous and may warrant some type of corrective action.
- **Process deviations:** one part of a process or of a subsystem/assembly affects the functioning of the whole system
- **Failure:** is the inability of an element to perform its required functions within specified performance requirements.
- **Hazard:** A condition that poses a threat of injury or damage to life, health, equipment, or the environment. Each hazard has at least one cause, which in turn can lead to a number of effects (e.g., damage, illness, failure).
  - A fault may or may not lead to a failure.
  - One or more faults can become a failure.
  - All failures are the result of one or more faults.

The **threshold check** is the most common way to identify abnormal conditions from monitoring points (e.g. temperatures, voltages, etc). Thresholds can identify

- **normal condition:** the nominal working range;
- **warning condition:** a range that require attention but without intervention;
- **abnormal condition:** a range that requires immediate action.

#### Alarms

- **Alarm Condition** refers to measurements (including also **Alarm Limits**) to indicate where awareness and/or response by an **Operator** is required to mitigate (potential) hazards and reduce (or prevent) harm (e.g. vitals, but could also be device characteristics).
- **Alarm** or **Alarm Signal:** audible and/or visible means of indicating to the **Operator** an equipment malfunction, process deviation, or abnormal condition requiring a timely response (ISA/IEC definition). The Alarm Signal is appropriate to the urgency required based on the criticality of the condition.
- **Alarm System** is a software system that deals with detecting the **Alarm Condition**, applying logic to determine what to do, and generating the **Alarm Signal** which is appropriate. An Alarm System could also show **Abnormal Status reporting**.

#### Events

An **event** is a notification that a warning condition, abnormal condition or faults have happened. An event could have the following categories:

- **information event**, to inform the **Operator** of some not warning or critical event;
- **warning event**, for warning conditions;
- **critical event**, for abnormal conditions or faults.

The reaction to an event could be:

- status reporting, for warning events
- alarm, for critical events.

An *event* could also trigger an **automated action** performed by the system. Fig. 10 shows relationship between conditions, fault, event, failure, alarms and status reporting.

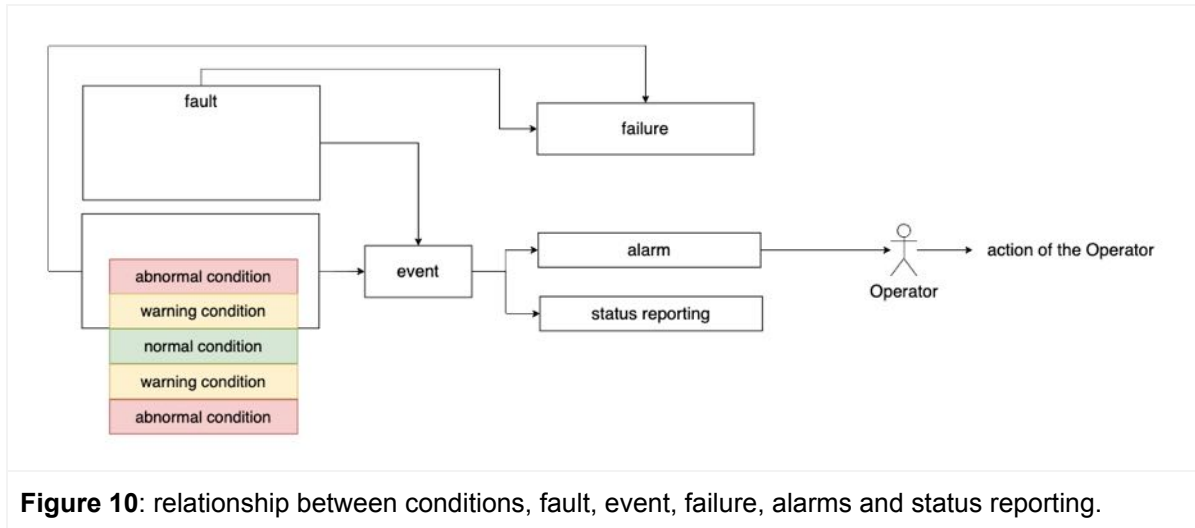

**Figure 10:** relationship between conditions, fault, event, failure, alarms and status reporting.

### Reporting & Acknowledging for Alarm System

It is important to clarify the distinction between alarm and abnormal status [RD19].

Abnormal status for an assembly means that one or more of its reported and monitored values are out of the normal range. **Abnormal Status reporting** is the action to report the status of components through colour coding, also taking into account special requirements of colour-blindness.

The Abnormal Status reporting is generated by **Abnormal Conditions** and is for the **Operator** but does not require any kind of action or acknowledgement.

An **alarm** means that an assembly has entered into an abnormal status and the **Operator** has not yet acknowledged this situation and the **Operator** must be informed to take action.

**Acknowledging** the alarm means that the alarm notification itself will be cleared, but not that the abnormal status will be cleared at the same time. Likewise if a component reports an alarm because of an abnormal status and the status returns to normal, either through user action or by itself, the alarm notification will not be cleared automatically either.

Note that an abnormal status does not always imply that a component is broken or out-of order.

### 3.6. The Mini-Array System Logical View

A high-level **logical view** of the **MA System**, with emphasis on the functional aspects, is given in the following sections of this chapter; only the main **subsystems** that has an impact on the software architecture (extracted from [AD6]) are listed in this section and shown in Fig. 11:

- Telescopes
- Array Calibration System
- Atmosphere Characterisation System
- Environmental Monitoring System
- Software
- On-site infrastructure
- ICT on-site and off-site
- Safety and Security System

A different logical grouping with respect to [AD6] is present for software modelling purposes.

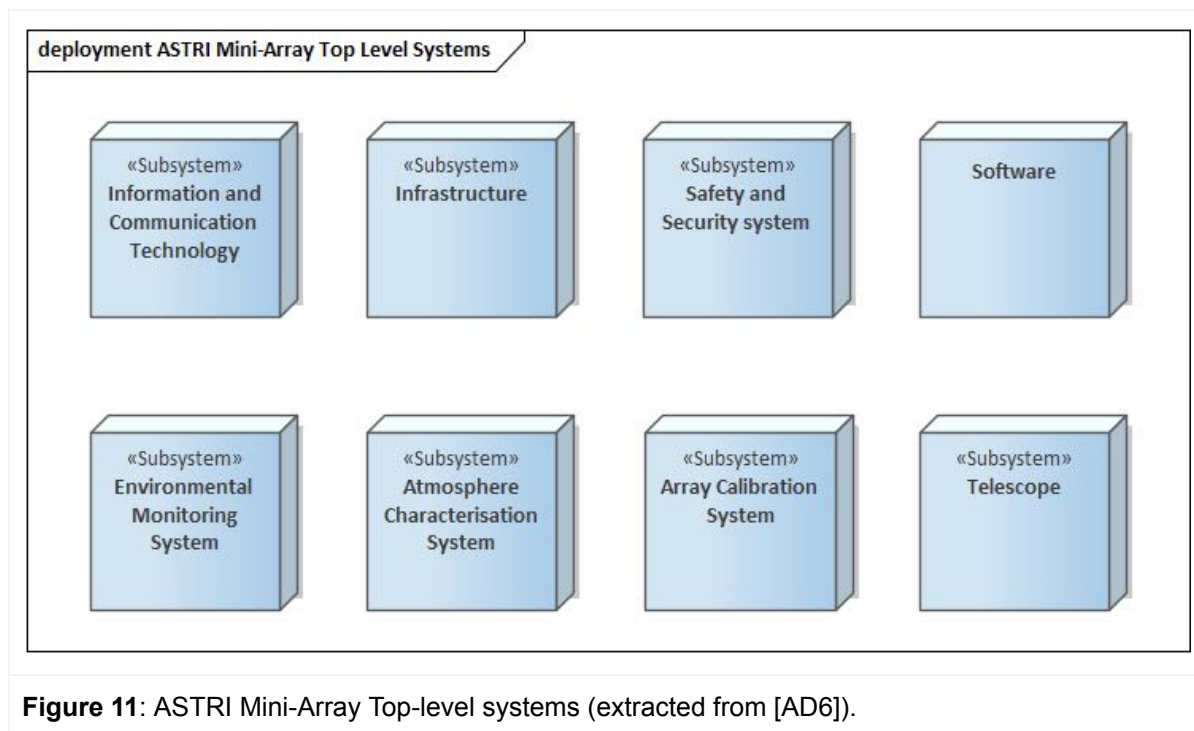

**Figure 11:** ASTRI Mini-Array Top-level systems (extracted from [AD6]).

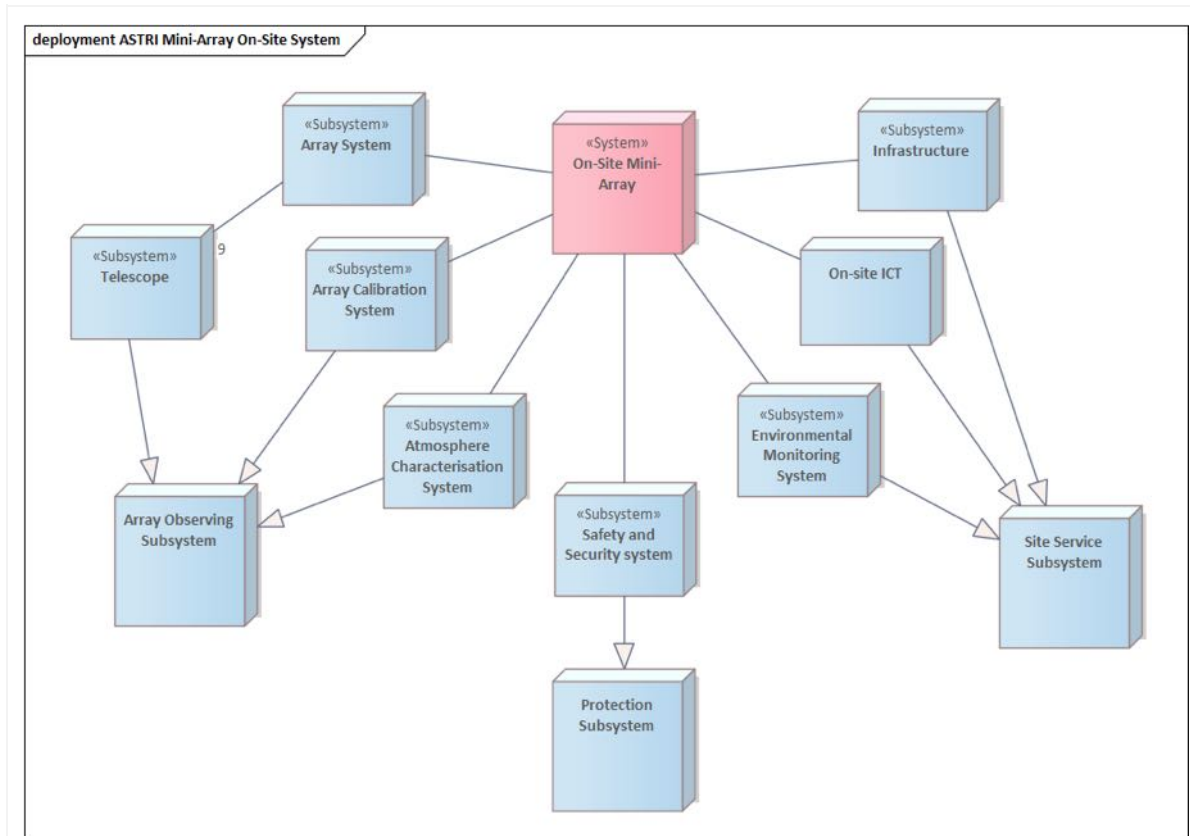

**Figure 12:** the on-site Mini-Array System. Generalisation rows indicate where Array Observing, Protection and Site Service subsystems are present. Nine telescopes form the Array.

All subsystems deployed at the site in Teide can be classified in one of three main categories (see Fig. 12):

- **Observing Subsystems** are:
  - the **Array System**, composed of **nine Telescopes** with their assemblies, including the two main scientific instruments permanently mounted on each telescope: the Cherenkov Camera and the Stellar Intensity Interferometry Instrument. A third instrument, the Optical Camera, can be mounted on a Telescope only for calibration and maintenance activities.
  - Atmosphere Characterisation System
    - LIDAR
    - SQM
    - UVSiPM
  - Array calibration system
    - Illuminator
- **Site Service Subsystems**
  - Infrastructure, in particular
    - Power Management System
  - Information Communication Technology, including HVAC
  - Environmental Monitoring System
    - Weather Station

- Humidity sensors
- Rain sensors
- All-sky camera
- **Protection Subsystems**
  - Safety and Security System



**Observing Subsystems, Site Service Subsystems and Protection Subsystems are Site Subsystems.**

### 3.6.1. Telescope System

The MA Telescopes that will be installed at Teide are an evolution of the small-sized Cherenkov telescope (SST, ~4 m in diameter) prototype developed by the Italian National Institute of Astrophysics (INAF) and installed in Italy at the INAF "M.C. Fracastoro" observing station (Mt. Etna, Sicily), ASTRI-Horn. The telescopes are optimized for very-high energy gamma-ray astronomy ( $E > 1$  TeV). Each of the nine telescopes is characterized by a dual-mirror optical system and a curved focal surface covered by SiPM sensors managed by non-conventional fast front-end electronics.



**Figure 13:** Telescope main assemblies

		<b>ASTRI Mini-Array</b> Astrofisica con Specchi a Tecnologia Replicante Italiana					
	<b>Code:</b> ASTRI-INAF-DES-2100-001	<b>Issue:</b>	2.5	<b>Date:</b>	Jun 18, 2021	<b>Page:</b>	28/119

The main telescope assemblies (see Fig. 13) are:

1. **Telescope Mount or Mount:** The telescope uses an Alt-Az mount to support and point the optical assembly and the scientific instrumentation at any target in the part of the sky accessible from the site. It uses a very compact mechanical configuration because the distance between the primary and secondary mirror is just 3 m. The Mount is part of the **Mechanical Structure Assembly** and includes the azimuth and altitude kinematic chains and drive systems, the stow-pin system and all sensors, actuators and controllers needed [RD17]. Details on Mount State Machine are reported in [RD17].
2. **Optical Assembly:** The optical design of the telescope is a modified dual-mirror Schwarzschild – Couder (SC) configuration to produce an aplanatic Field of View (FoV) of more than 10 degrees. Eighteen aspheric hexagonal segments, produced with the cold slumping technology, compose the primary mirror (M1) with three different radii of curvature in three coronas. To assure the alignment and stability of this optical configuration each segment is mounted on three points. The secondary mirror (M2) is an aspheric monolithic shell 1.8 m in diameter obtained with hot slumping technology. M2 can be moved through three actuators.
3. **Cherenkov Camera (Camera):** The mirrors of the telescope dishes focus on the Cherenkov Cameras the Cherenkov light emitted during the development of the extensive air showers induced by the interaction of the primary cosmic-rays and VHE gamma rays with the atmosphere. The cameras record the light and, following a trigger condition, send data to the data acquisition system. The photodetectors are the SiPM detectors that populate the focal plane. The camera electronics comprises the Front-End Electronics Board (FEE), the FPGA Board, and the Back-End Electronics (BEE). The main function of the FEE and of the FPGA boards is to convert the analog SiPM signals into digital signals while the BEE controls and manages the overall system, including data management formats, Lid mechanisms and a fiber-optic calibration tool. In addition, the BEE provides the needed functions to process and transmit the images, as produced by the FEE, to the Cherenkov Camera Data Acquisition system.
4. **Stellar Intensity Interferometry Instrument (SI<sup>3</sup>):** The SI<sup>3</sup> (or Photon Detection Module for Intensity Interferometry; PDMII) is a dedicated optical photon detection module for performing intensity interferometry observations with the ASTRI telescopes. The module incorporates a focal plane optics and a dedicated front-end electronics.

Auxiliary devices:

1. **Optical camera:** it is a CCD/CMOS camera used for the optical alignment of the telescope mirrors during AIV and maintenance operations. To use this camera, the Cherenkov camera must be dismantled from the telescope.
2. **Pointing Monitoring Camera (PMC):** This system is installed on the rear of the M2 support structure to obtain astrometric calibrated FoV of the region pointed to by the telescope. The system is based on a CCD camera and systems of lenses to assure a FoV of about 3x2 deg and a pixel sampling of about 7 arcsec, a sky coverage wide enough and sampled enough to obtain an astrometric accuracy of 5 arcsec over the full sky. The PMC with its astrometric calibration could be also used to implement a telescope-pointing model TPOINT-like with grid pointing directions over all the sky.
3. **Telescope Condition Monitoring:** This system (not shown in Fig. 13) consists of accelerometers and temperature sensors mounted on the telescope drive system. The data provided by these sensors combined with the motor currents, voltage and speed will allow condition-based maintenance to limit system downtime and spare part stocks. The output

signals of these sensors are read by dedicated Beckhoff modules connected to the **Telescope Control Unit** and managed by the **Mount LCS**.

4. An **Optics Alignment System** used for the alignment of the mirrors that includes the **Optical Camera** and the mirrors actuators
5. The **Telescope Protection System** is part of the **Safety and Security System** and guarantees the safety of the telescope and of the people during operation and maintenance activities. It includes a fire protection system [RD17].

The telescope has a **safe state**: the telescope is in parking positions with the camera lids closed and the Cherenkov cameras switched off.

### 3.6.1.1. Telescope Local Control System

The **Telescope Local Control System** is a set of Local Control Software and hardware to control the different assemblies of the telescope. As a design choice the **Telescope Local Control System** of any MA telescope shall be considered a stand-alone system able to manage all the allocated functions listed in [RD17]. In this way the **Telescope Control System** (part of SCADA and described in Sect. 5.2.14.) shall be concerned only with the business logic and not with the details of the low-level hardware control operations. These functions shall be delegated to several **Local Control Systems** installed on board the telescope and that are part of the Telescope Local Control System. Each Local Control System has a **Local Control Software** (LCS) running on a set of PC/PLCs (see Fig. 14) that controls the main assemblies of the telescope.



**Figure 14:** Telescope Local Control System's main Local Control Software.

Based on the lessons learned designing and operating the ASTRI-Horn Telescope ([RD13], [RD14], [RD15], [RD16]) the main Telescope Local Control Software shall be responsible for providing all the telescope functionality needed to perform normal operations, error management, testing, maintenance and calibration activities. The subsystems that do this are:



- The **Mount Local Control Software (Mount LCS)** shall be responsible for the control of the motion of the mechanical structure (including the kinematic chains and the drives). This system runs on the **Telescope Control Unit (TCU)** [RD17]. The Mount LCS also manages the **Telescope Condition Monitoring** sensors.
- The **Telescope Health and Safety LCS** shall be responsible for monitoring the status of all telescope subsystems and for the startup and shutdown of all the assemblies mounted on the telescope, including the instruments and the commissioning and maintenance mechanisms that will be temporarily mounted on the Mount Assembly. This system runs on a **Telescope Health Control Unit (THCU)** and shall be able to receive triggers from the telescope **Safety Unit** in case of any hazards requiring the telescope to reset to safe state [RD17]. Note that the Telescope Health and Safety LCS has in charge to switch on/off the following assemblies, even if they are part of the **Atmosphere Characterisation System**:
  - The **SQM LCS**: there are two telescopes with one SQM each, the SQL LCS is the local control software of the SQM (see Sect. [3.6.3.](#)).
  - The **UVSiPM LCS**: there is one telescope with one UVSiPM, the UVSiPM LCS the local control software of the UVSiPM (see Sect. [3.6.3.](#)).
- The **Optics LCS** shall be responsible for the control of the M2 mirror (focusing) and of the special mechanism that will be used to align the M1 segments during the telescope commissioning and maintenance. The Optics LCS shall run on the **Optics Control Unit (OCU)** [RD17].
- The **Cherenkov Camera Local Control Software (CLCS)** shall run on the Back End Electronics (BEE) of the Cherenkov Camera. It shall be responsible for the management, in terms of control and monitoring operations, of all the hardware subsystems attached to the BEE which make up the Cherenkov Camera. This implies management of the physical communication interfaces, communication protocols and message protocols adopted by the different hardware subsystems devices. In addition, the CLCS shall manage the data exchange with the FPGA components of the BEE in order to provide all the needed information and interaction with firmware and create and send telemetry packets.
- The **Stellar Intensity Interferometry Instrument Local Control Software (SI3LCS)** is the local control software of the SI<sup>3</sup>.
- The **Optical Camera Local Control Software (OCLCS)** is the local control software of the Optical Camera.
- The **Pointing Monitoring Camera Local Control Software (PMCLCS)** - the local control software of the Pointing Monitoring Camera.

The Telescope Local Control Systems shall interface with the **SCADA/Telescope Control System** via the OPC-UA protocol.

Each telescope's Local Control System shall provide a **Local Engineering HMI**, which shall be also accessible with a tablet or mobile phone for configuration, test and maintenance activities.

The ASTRI-Horn heritage of the Telescope Local Control System is reported in [RD13]. A detailed description of the TCU and of the THCU are reported in [RD14] and [RD15] respectively.

### 3.6.2. Environmental Monitoring System

The **Environmental Monitoring System** is a set of assemblies and devices for the evaluation of the environmental conditions. The MA assemblies forming this **Environmental Monitoring System** must operate 24 hours a day. All the acquired ENV data types must be archived in the proper repository (local and remote) and made available for the human readable weather report as well as support for the analysis of scientific observations. All ENV parameters are sent to the **Monitoring System**. An essential set of the ENV parameters is sent to the **Alarm System** to inform the **Operator** (see Sect. 5.2.7.) about alarms which could determine immediate reactions during the night to change schedule and to the **Central Control System** to put the assemblies in safe state in an automated way.

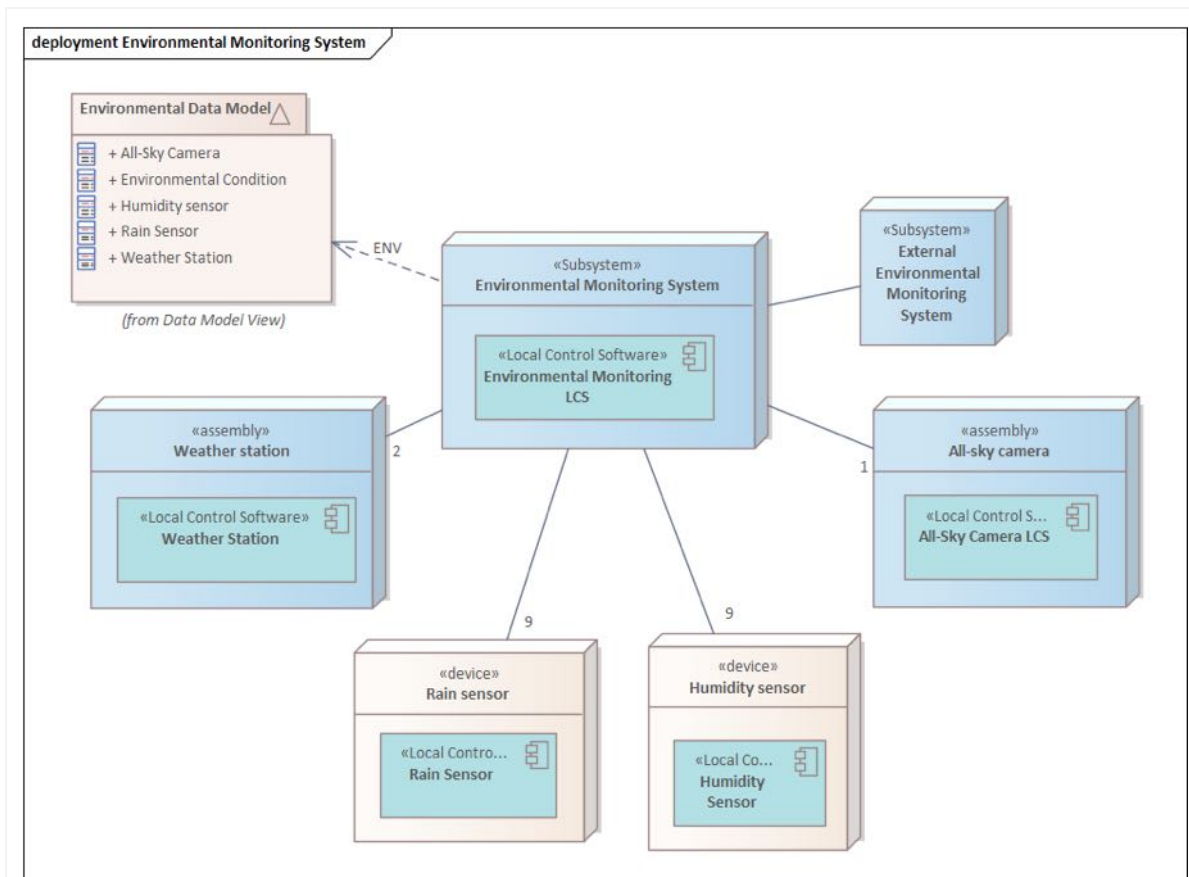

**Figure 15:** Environmental Monitoring System assemblies, and Local Control Softwares. Nine humidity sensors and nine rain sensors (one for each cabinet). All-sky camera: position must be defined. Two weather stations are present.

The **Environmental Monitoring Local Control System** is a set of hw and Local Control Software to control the different assemblies of the **Environmental Monitoring System**.

The subsystems (and related LCS) are:

1. **Weather Station(s)** (ref. ASTRI-UC-0-030). The ASTRI MA telescopes will perform observations unless the weather does not allow them; this control is managed by the

continuously active two weather stations. The entire set of all weather stations parameters will be monitored and archived at least every 2 seconds. Temperature, wind speed and direction, relative humidity, amount and type of precipitation form the set of critical parameters for the safety of humans and equipment and must be collected also by the **Alarm System** (see Sect. [5.1.12](#)). The **Weather Station LCS** is the local control software of the weather stations.

2. **Rain Sensor(s)** (ref. ASTRI-UC-0-030). Each ASTRI MA telescope service cabinet is equipped with one rain sensor for prompt detection of rain; further rain sensors are located in the weather stations but they are not counted here. All parameters from any rain sensor must be logged and archived at least once every 2 seconds. The **Rain sensors LCS** is the local control software of the rain sensors.
3. **Humidity sensors**. Each Telescope service cabinet is equipped with an external humidity sensor. The **Humidity sensor's LCS** is the local control software of the humidity sensors.
4. **All-Sky Camera (ASC)** (ref. ASTRI-UC-0-030). The monitoring of cloud coverage both during daylight and night time is provided by the all-sky camera. The images, acquired at a predefined time interval (TBD), allow evaluating the cloudiness of the sky. During the night, the **All-Sky Camera Local Control Software**, the local control software of the ASC, shall evaluate the cloudiness around the pointing direction of the current ASTRI MA observation (about 10° TBD). The cloudiness values must be sent to the SCADA system and archived. The global cloudiness will be mainly used while the knowledge of cloudiness along the pointing direction will act as support for the data quality check and data selection. The ASC images shall be archived as well. The possibility of deriving the full sky atmospheric extinction map is under investigation.

**SCADA** has a dedicated collector that allows it to read monitoring points, alarms, errors, status and log information. This system is described in Sect. [5.2.15](#)) and is part of the SCADA system.

### 3.6.3. Atmosphere Characterisation System

The **Atmosphere Characterisation System** is a set of assemblies for the atmosphere characterisation, (see Fig. 16) and shall operate during the night observation period. All the acquired ATM data types must be archived in the proper repository (local and remote) and made available for the human-readable atmosphere report as well as support for the analysis of scientific observations. No alarms are generated by the data of this system, but the presence of dust (or dust storm) could jeopardize the observation data quality. The level of dust in the atmosphere is determined from LIDAR data.

The **Atmosphere Characterisation Control System** is an software system used to control, configure and get the status of all assemblies of the **Atmosphere Characterisation System**. This system is described in Sect. [5.2.16.](#)) and is part of the SCADA system.

The **Atmosphere Characterisation Local Control System** is a set of hw and Local Control Software to control the different assemblies of the Atmosphere Characterisation System. It provides an OPC-UA interface that is used by the **Atmosphere Characterisation Control System**.

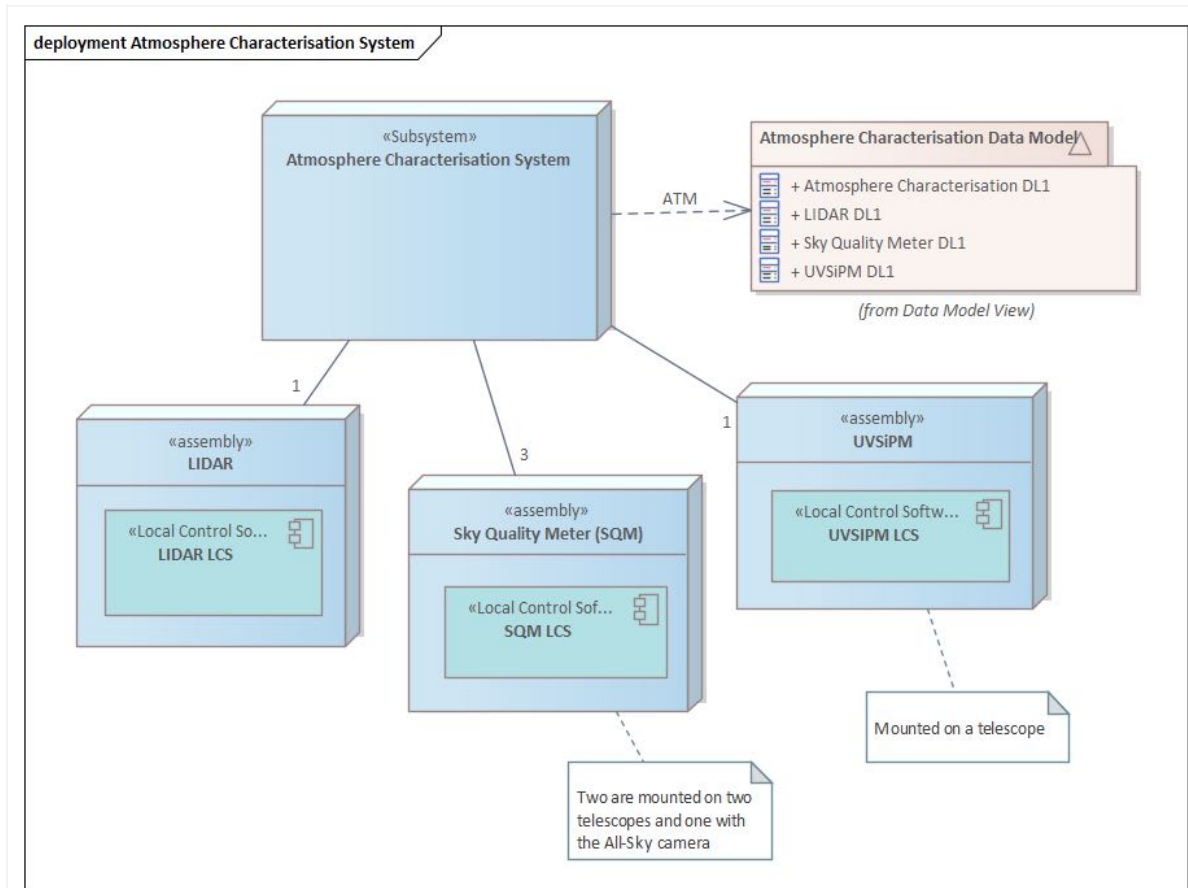

**Figure 16:** Atmosphere Characterisation System. Assemblies and their Local Control Software. There are two SQM mounted on two telescopes and one with the All-Sky camera. The UVSIPM is mounted on a telescope.

The subsystems of the **Atmosphere Characterization System** are:

1. **LIDAR** (ref. ASTRI-UC-0-035). The LIDAR (Light Detection And Ranging) allows us to study the atmospheric composition, structure, clouds and aerosols through the measurement of the atmospheric extinction profile. The LIDAR should perform pointed observations and will be used to monitor atmosphere conditions up to an altitude of 15 km (TBC). The **LIDAR LCS** is the local control software of the LIDAR.
2. **SQM** (ref. ASTRI-UC-0-035). A quick evaluation of the sky quality during observations is obtained using the Sky Quality Meter (SQM) that measures the brightness of the night sky in magnitudes per square arcsecond with a 10% precision (TBC). Two SQM are mounted on two telescopes and one with the All-Sky camera. The system returns integral information about background light intensity inside its FoV (20 deg TBC) on demand up to, generally, a frequency of 1 Hz. The **SQM LCS** is the local control software of the SQM.
3. **UVSiPM** (ref. ASTRI-UC-0-035). UVSiPM is a light detector that measures the intensity of electromagnetic radiation in the 300–900 nm wavelength range. The UVSiPM instrument, whose technical design is currently in progress, will be essentially composed of a multipixel Silicon Photo-Multiplier detector unit coupled to an electronic chain working in Single Photon Counting (SPC) mode, and the onboard computer devoted to the management of all functions and subsystems forming the instrument and to the communication with external

actors. The detector unit of UVSIPM is of the same kind as the ones forming the camera at the focal plane of the ASTRI MA telescopes. It is possible to equip the UVSIPM instrument with a collimator to regulate its angular aperture (FoV). Only one UVSIPM unit is currently foreseen for the entire array; mounted on the external structure of one of its telescopes, and centred with the related ASTRI camera. The analysis of the UVSIPM data thus acquired will be mainly used to evaluate the level of diffuse night sky background, at a frequency to be defined (e.g., once per second), around the ASTRI telescope pointing direction (within the given FoV, less or equal to the ASTRI MA telescope field of view, depending on the UVSIPM collimator length). UVSIPM housekeeping (HK) and scientific acquisition data (i.e. counts/second/pixel, R0 level) must be sent to SCADA both for a quick analysis on-line and a deeper analysis off-line, whose results must be archived. The **UVSiPM LCS** is the local control software of the UVSIPM.

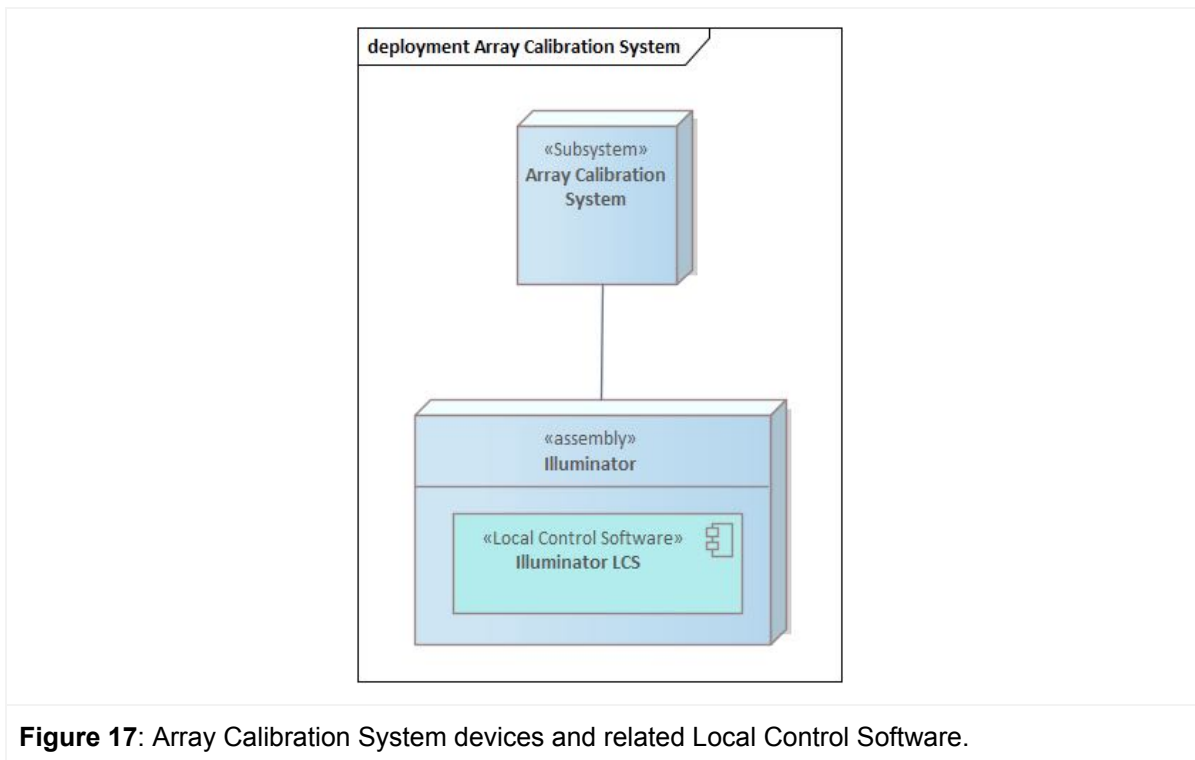

### 3.6.4. Array Calibration System



**Figure 17:** Array Calibration System devices and related Local Control Software.

The calibration of the array can be accomplished by applying a set of tools (methods and equipment) that will update characteristic parameters, necessary to ensure that the ASTRI Mini-Array fulfils all high-level performance requirements. The data to be analysed by the software are directly those acquired by the Cherenkov cameras (scientific EVT and/or VAR data) observing a given source, natural or artificial (ref. ASTRI-UC-0-051). The data from the artificial source would be provided by the **Illuminator**.

The **Array Calibration System** for Cherenkov data is the set of assemblies for the calibration of the Cherenkov cameras. The **Illuminator** is part of this system.

		<b>ASTRI Mini-Array</b> Astrofisica con Specchi a Tecnologia Replicante Italiana					
	<b>Code:</b> ASTRI-INAF-DES-2100-001	<b>Issue:</b>	2.5	<b>Date:</b>	Jun 18, 2021	<b>Page:</b>	35/119

The **Array Calibration Control System** is a software system used to control, configure and manage the status of all assemblies of the **Array Calibration System**. This system is described in Sect. [5.2.17](#)) and is part of the SCADA system.

The **Array Calibration Local Control System** is a set of hw and Local Control Software to control the different assemblies of the Array Calibration System. The Illuminator device has its own Local Control Software, the **Illuminator Local Control Software**.

**Illuminator** (ref. ASTRI-UC-0-051). The Illuminator is a portable ground-based device, remotely controlled, designed to uniformly illuminate the ASTRI MA telescope's aperture with a pulsed or continuous reference photon flux whose absolute intensity is monitored by a NIST-calibrated photodiode. The analysis of the ASTRI MA Cherenkov camera(s) data acquired pointing each telescope towards the Illuminator will allow measuring their detailed response efficiencies. Using different illumination features (wavelength, intensity, pulse length) as well as changing the telescope pointing towards the Illuminator, several calibration purposes can be accomplished, even with respect to off-axis angles. Among them, the overall telescope spectral response (including mirror reflectivity and detector efficiency) can be measured to obtain, for each Cherenkov camera pixel (or for each group of a few pixels), the corrective factor for the flat fielding of the Cherenkov camera. The Illuminator is designed to be first used during the commissioning phase of the ASTRI MA telescope: one after the other, all ASTRI MA telescopes will be calibrated against the same reference light source and configuration. This calibration will be repeated periodically (e.g. once a year) or when required, e.g. if significant change or degradation of the response of the telescope(s) is suspected. The **Illuminator LCS** is the local control software of the Illuminator.

### 3.6.5. Site Infrastructure Systems

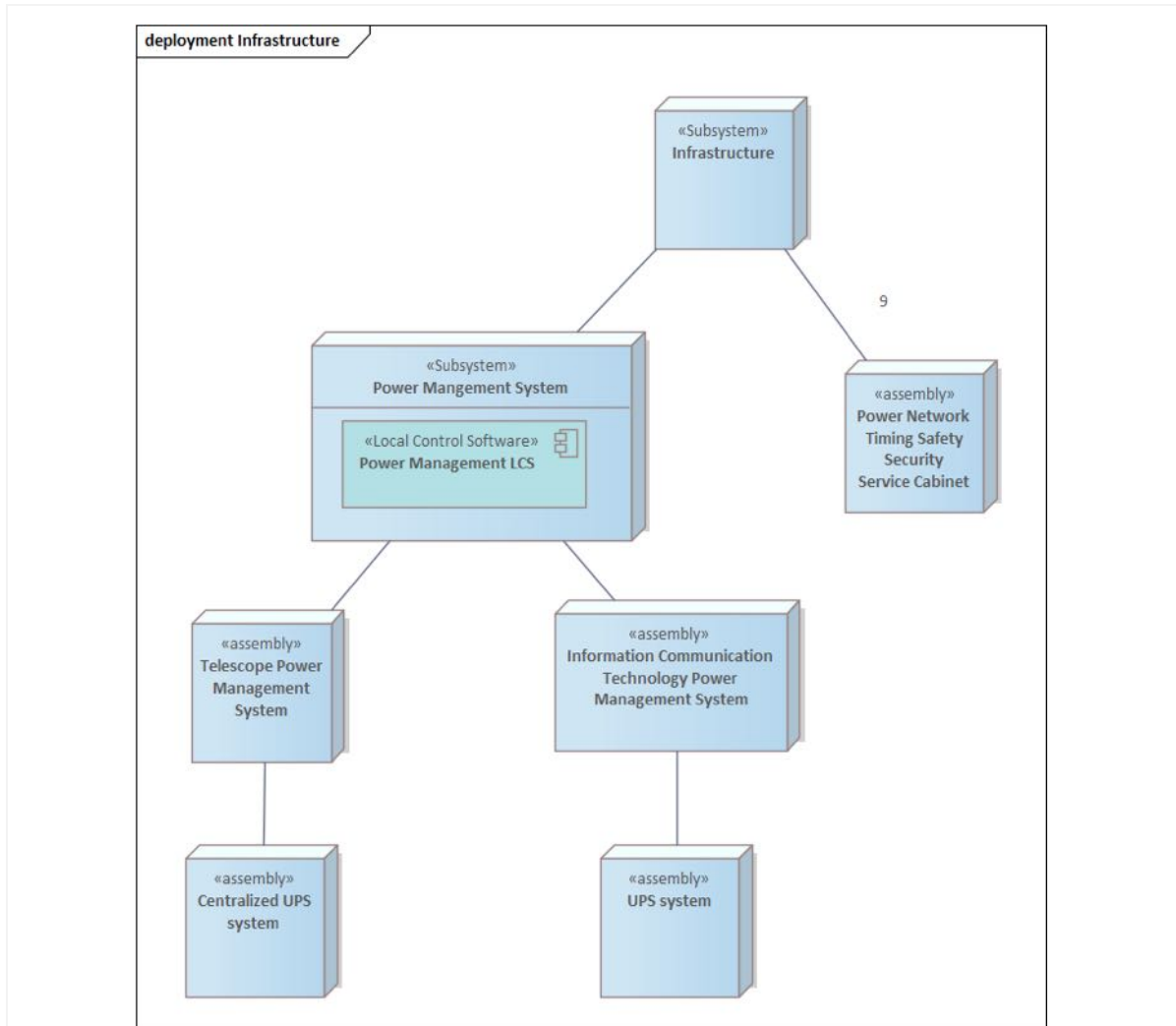

**Figure 18:** Site Infrastructure Systems.

The **Site Infrastructure System** subsystems are:

1. **Power Management System:** the **Power Management Local Control System** is an hw/sw system used to control, configure and get the status of all subsystems of the **Power Management System**:
  - a. **Telescope Power Management System** including centralized UPS system;
  - b. **Information Communication Technology Power Management System**, including UPS system.
2. **Service cabinets**

**SCADA** has a **Power Management System Collector** that allows it to read monitoring points, alarms, errors, status and log information.



### 3.6.6. Safety and Security System

The **Safety and Security Local Control System** is a set of hw and Local Control Software to control the different assemblies of the Safety and Security System.

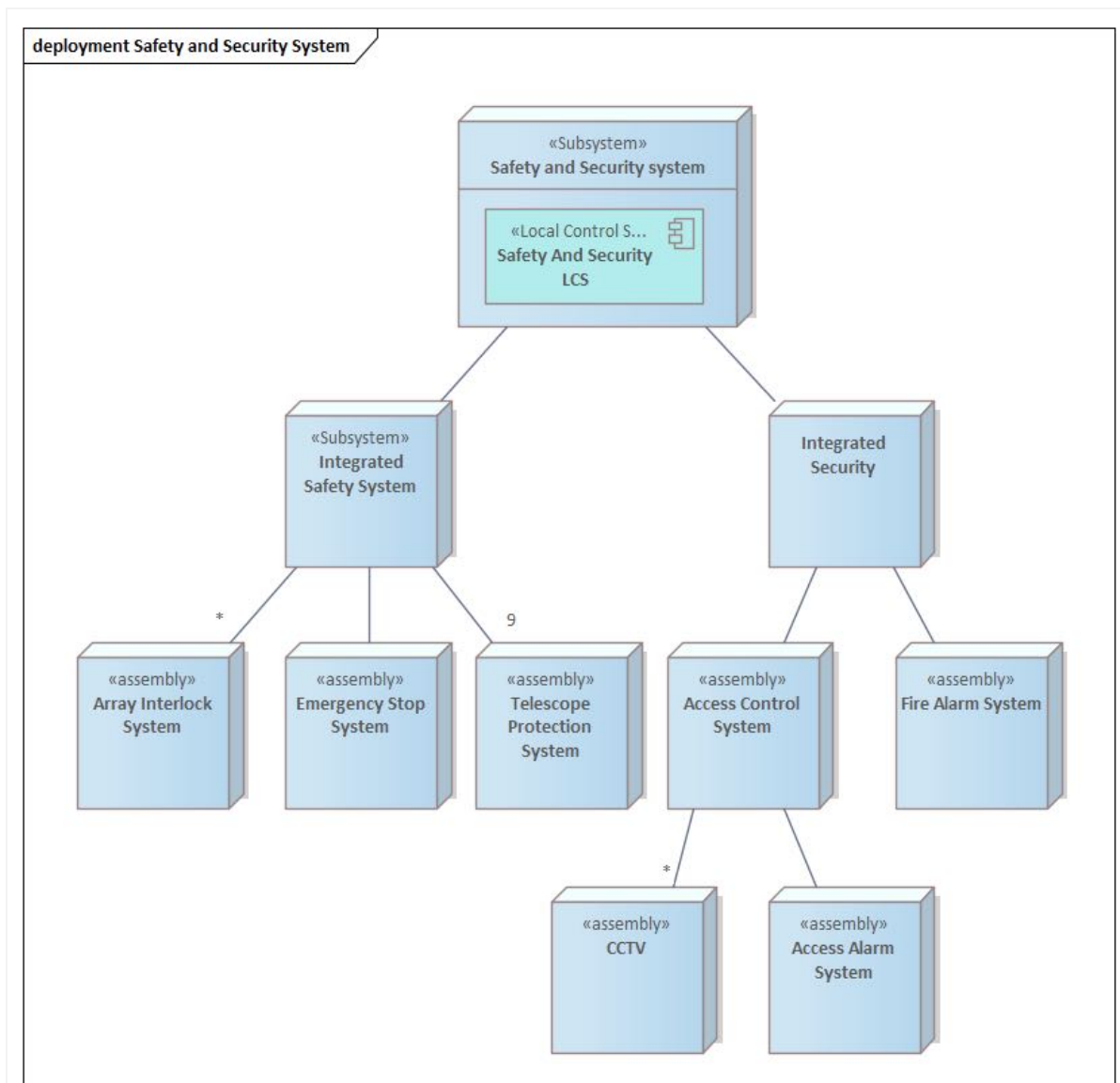
**SCADA** has a **Safety and Security System Collector** that allows it to read monitoring points, alarms, errors, status and log information.



**Figure 19:** Safety and Security System assemblies and related control system. There will be one CCTV per telescope plus one for each tower (with a weather station) plus one for each container. There will be one Interlock System per telescope.

		<b>ASTRI Mini-Array</b> Astrofisica con Specchi a Tecnologia Replicante Italiana					
	<b>Code:</b> ASTRI-INAF-DES-2100-001	<b>Issue:</b>	2.5	<b>Date:</b>	Jun 18, 2021	<b>Page:</b>	38/119

### 3.6.6.1. Integrated Safety System

The **Integrated Safety System (ISS)** shall be a PLC based system not depending on any other site installed system other than power. This system shall implement different operation modes to allow science observing operation, maintenance and fault and interlock recovery. The functional safety actions associated with faults, interlock requests and emergency stop shall be defined based on an accurate system/subsystem hazard analysis. The ISS shall have a simple user interface, accessible remotely via authenticated access control, to allow operators to perform a simple action like interlock reset or check interlock status. The ISS shall provide an OPC-UA server to provide SCADA with information about interlock status etc.; it will be the **Alarm System** that will activate visible and audible alert devices.

In case of a fault in any site installed system the ISS will interlock any other system that could be in a hazardous situation because of that fault.

The ISS shall be connected to the site emergency stop (E-Stop) system that if activated shall trigger an ISS emergency stop function. Emergency stop devices must be a backup to other safeguarding measures and not a substitute for them (i.e., the E-Stop is distinct from any other local switches or buttons that shut off power or stop motion of an individual machine or device). E-Stop devices shall be appropriately distributed throughout the site (e.g. local control room, service cabinet) in order to facilitate a quick activation from different locations in case of an emergency (e.g in a location where an operator can be).

If activated the E-stop shall activate an emergency stop function in the ISS to command all systems to enter into a safe state, (i.e., stop of any of the hazardous processes as quickly as possible, without creating additional risks, and where necessary, trigger or permit the triggering of certain safeguard movements such as parking a telescope, this could also include powering-off all non-essential subsystem of a telescope). The emergency stop function must be available and operational at all times, regardless of the operating mode (see EU Machinery Directive, 2006/42/EC - 3, Annex I, 1.2.4.3).

It must be possible to disengage the E-Stop device only by an appropriate operation, and disengaging the device must not restart the system but only permit restarting. The possibility to use wireless E-Stop by people on the field should also be evaluated.

### 3.6.6.2. Integrated Security System

This **Integrated Security System** is intended to protect life, property and environment. It shall provide an intruder alarm system, closed-circuit television used for security and surveillance (CCTV), access control system, fire detection and fire alarm systems, environmental alarm systems, power alarm system. The local regulations for operating CCTVs must be respected. The access control system should cover all MA buildings (doors) and telescopes (gates/doors) on fences to ensure safety.

Environmental alarms must also cover data center temperatures.

### 3.6.7. ICT System

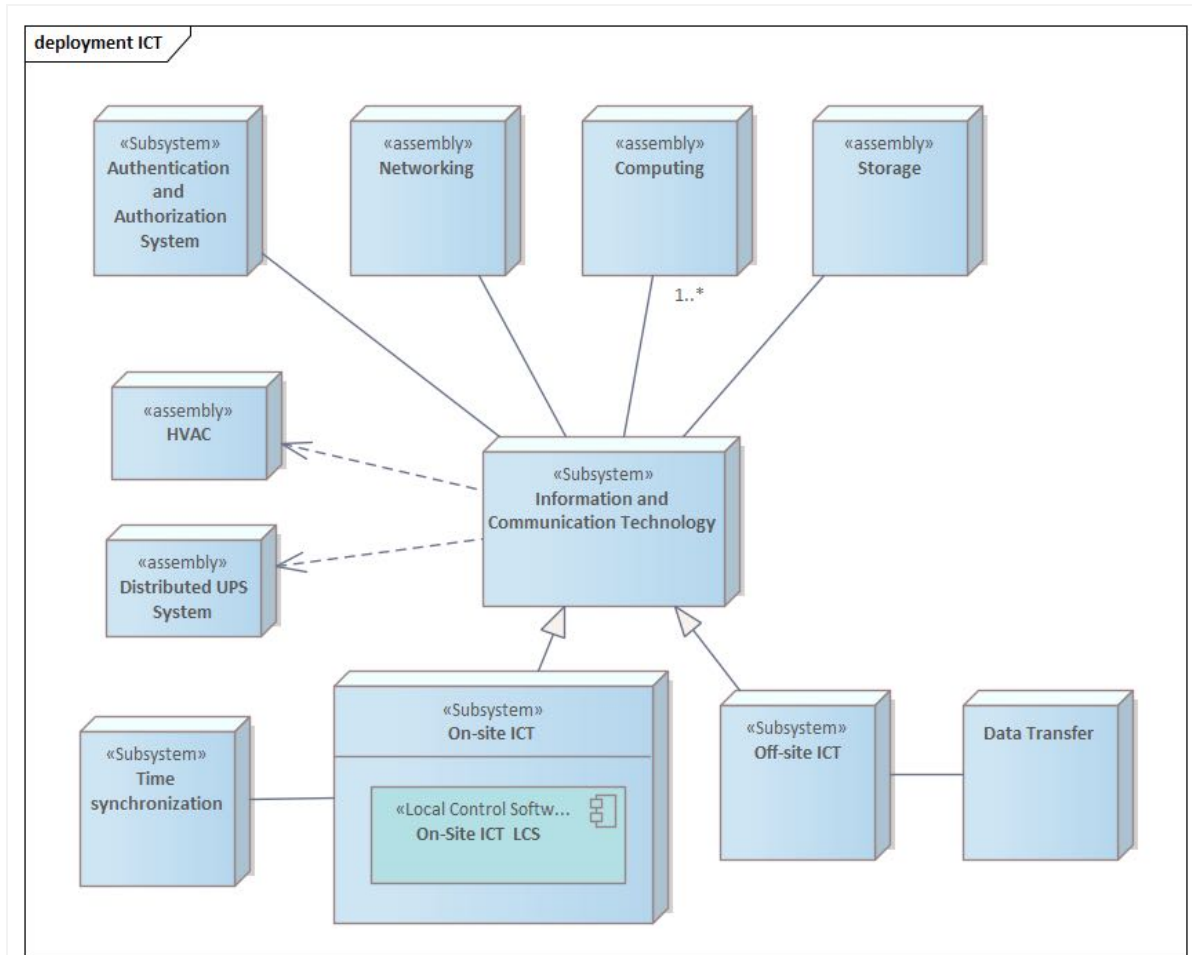

**Figure 20:** ICT System



The MA **Information and Communication Technology (ICT) System** includes:

- the **On-Site ICT**, a.k.a. **ASTRI Array Observing Site (AOS) Data Center**;
- the **Off-Site ICT**, a.k.a. **ASTRI MA Data Center**.

The main subsystems are:

- **HVAC** (Heating Ventilation and Air Conditioning) and **UPS system**
- **Networking**
- **Computing**
- **Storage**
- **Authentication and Authorization System**

A sketch of the physical layout of the **AOS Data Center** is described in Sect. [3.7.1](#) The **On-Site ICT Local Control System** is a set of hw/sw system used to control, configure and get the status of all assemblies/devices of the **On-Site ICT System**, that shall include an **ICT Monitoring System** that must be a separate, autonomous set of systems that monitors the status of the On-Site ICT System.

		<b>ASTRI Mini-Array</b> Astrofisica con Specchi a Tecnologia Replicante Italiana					
	<b>Code:</b> ASTRI-INAF-DES-2100-001	<b>Issue:</b>	2.5	<b>Date:</b>	Jun 18, 2021	<b>Page:</b>	40/119

A [Time Synchronization and Distribution System](#) distributes the timestamp to camera servers.

SCADA has an [On-Site ICT System Collector](#) that allows it to read monitoring points, alarms, errors, status and log information from the ICT system.

A description of the physical layout of the **MA Data Center** is described in Sect. [3.7.2](#). A [Data Transfer Node](#) to manage the data transfer off-site/on-site is present.

## 3.7. The Mini-Array System Physical view

### 3.7.1. Physical view of the Array Observing Site

The ASTRI MA Software System at the Array Observing Site (AOS) needs proper ICT infrastructure in order to achieve the scenarios detailed in [AD3]. The physical architecture of the MA System at the Array Observing Site (AOS) is depicted in Fig. 21.

The two main contexts of the ICT infrastructure are:

- the telescope context that includes all the computers and network systems needed to operate the telescopes;
- the [AOS Data Center](#) context includes the computing/storage hardware, the overall networking infrastructure (cabling and switches) and the system services (operating system, networking services, name services, and other to be detailed) needed for the data management on site.

The required components in the telescope context are:

- a service cabinet which contains:
  - the patch panel that is a panel with optical sockets where the optical fibers connect the telescopes to the data center;
  - the service switch to provide, monitor and control the supporting services (e.g. Close Circuit TV (CCTV) system).
- the Local Area Network (LAN) which is realized through an industrial switch. The LAN provides a dedicated connection among the telescope devices and the AOS data center.
- the systems to control the main telescope devices (see Sect. [3.6.1.1](#)):
  - **Telescope Control Unit (TCU)**: the industrial PC running the software which is in the charge of the monitoring and control of the elevation and azimuth axes motion;
  - **Optics Control Unit (OCU)**: the industrial PC that runs the Optics LCS;
  - **Telescope Health Control Unit (THCU)**: the industrial PC running the software and safety logic which are in charge of the interlock chain and power management of the telescope and of the monitoring of the health of all telescope assemblies.
- the safety system which is implemented by dedicated Programmable Logic Controller (PLC) devices (**Safety PLC**).

The required components in the AOS data center context are:

- the **network system** which is a high-speed LAN required for the data connection. It is composed by:
  - a **patch panel** which provides optical sockets where the optical fibers connect the data center to the telescopes;
  - the **main switch** needed to connect the servers, the devices and the secondary switches together;
  - the **firewall** and the router needed to guarantee a secure connection of the AOS data center to the Wide Area Network (WAN) and to the internet;



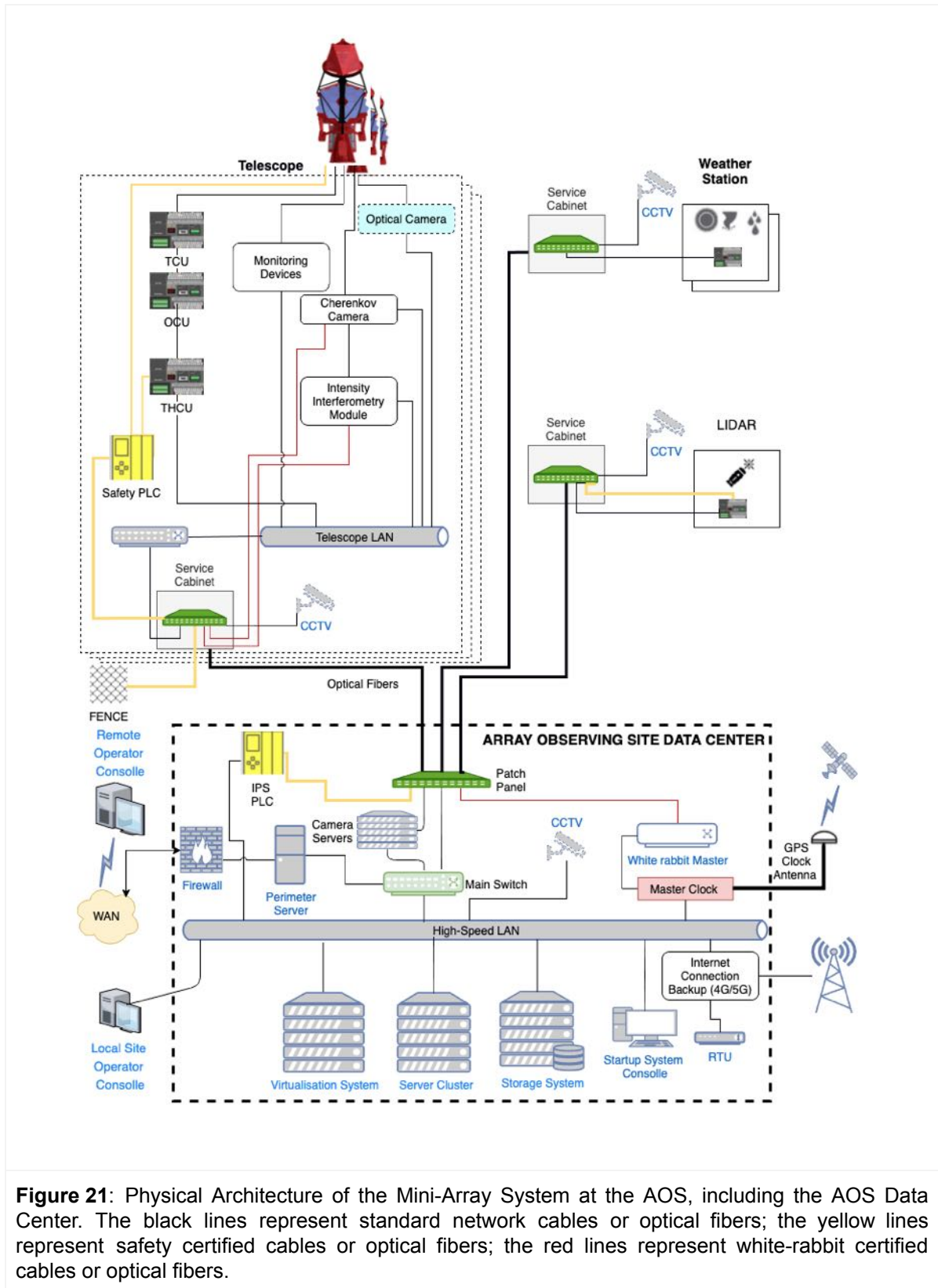

- the **internet connection backup** system which provides the remote communication when the WAN is down. It can be implemented via 4G / 5G (TBD).
- the **network services** that are the services needed for the network operations:
  - Domain Network System (DNS) which shall run in a dedicated physical server;
  - the authentication and authorization system which shall run in a virtual machine;
  - the Network Time Protocol (NTP) that is realized by the master clock;
  - the File Transfer Protocol (FTP);
  - the Web Server (WS) and the command line access Secure Shell (SSH) which shall run on a perimeter server.
- the **perimeter server** is a particular server connected both to the ASTRI MA private network and to the Internet. The perimeter server shall be used for data transfer through the FTP, the data sharing, the connection to the networking nodes through the SSH connection;
- the **camera servers** are the physical servers aimed at the Data Acquisition (both Cherenkov Camera and Stellar Intensity Interferometry Instrument) and storage in the storage system. The camera servers are connected to the patch panel since the camera shall transmit the raw data stream to the camera server through a dedicated point to point optical connection;
- the **storage system** represents the local bulk repository for the raw data files. These files shall be available for the on-site analysis (during the SVP) and for the transfer to the remote archive. The storage system provides a shared, distributed and parallel file system, in order to ensure the high reliability and availability. It is supported by a dedicated hardware. Whose architecture is linked to the choice of the file system (BeeGFS, Lustre etc ...);
- the **virtualizations system** based on a complete enterprise solution. The virtualization system provides the management of the virtual machines (VMs), the containers, the software-defined storage and networking, and the high-availability clustering. The virtualization system shall host the virtual machines that will be used for the telescopes control;
- the **server cluster** is a set of physical servers dedicated at running the observation quality system, the alarm and monitoring system and the scientific pipelines during the commissioning phase;
- the **Startup System** is the system capable of turning on the whole **critical on-site systems**;
- the **time synchronization and distribution system** that is composed by:
  - the **white rabbit master** switch that implements the white-rabbit technology. It shall connect the white rabbit boards to the telescopes in order to synchronize the telescope devices;
  - the **master clock**: that is a Network Time Protocol (NTP)/Time Precision Protocol (PTP) server suitable for the servers synchronizing and the white rabbit system;
  - Global Positioning System (GPS) clock and antenna;
- the **ICT monitoring system** is a separated and autonomous system that shall be provided and executed before any other. This monitoring system shall be used to detect the failures of the IT infrastructure and it shall connect the LAN, the internet backup system. The ICT monitoring system provides a control network, i.e. a backup switch to monitor the equipment in case of failure of the master switch.

The AOS data center shall be installed at Teide, where the telescopes and all Observing Site subsystems are installed. The data center shall be installed in a dedicated server room and properly configured for the ASTRI MA System. The data center shall be equipped with a Heating Ventilation and Air Conditioning (HVAC) system to maintain the optimal environmental conditions. An Uninterruptible Power Supply (UPS) system shall be installed to prevent sudden power cuts in case of power grid connection loss and an automatic fire suppression system.



**Figure 21:** Physical Architecture of the Mini-Array System at the AOS, including the AOS Data Center. The black lines represent standard network cables or optical fibers; the yellow lines represent safety certified cables or optical fibers; the red lines represent white-rabbit certified cables or optical fibers.

		<b>ASTRI Mini-Array</b> Astrofisica con Specchi a Tecnologia Replicante Italiana					
	<b>Code:</b> ASTRI-INAF-DES-2100-001	<b>Issue:</b>	2.5	<b>Date:</b>	Jun 18, 2021	<b>Page:</b>	43/119

### 3.7.2. Physical view of the ASTRI MA Data Center

The **ASTRI MA Data Center** in Rome will host the long-term data Archive of the ASTRI MA and it will be designed to store and preserve all the data produced during the ASTRI MA operations (see Sect. [5.3](#)). Moreover, the Data Center will guarantee enough computing and storage resources to run the scientific data processing pipelines (**Data Processing System**, see Sect. [5.4](#)) and the ASTRI MA simulations (**Simulation System**, see Sect. [5.6](#)), needed to characterize the detector response and the MA scientific performances. The Data Center will also host services to support the **Science Users** in several phases of the Observing Project execution, from the OP submission to the retrieval of the high-level scientific data and the Science Tools needed for their analysis. It will also provide a suitable tool for the observation plan preparation (**Science Support System**, see Sect. [5.5](#)).

The Data Center shall fulfill the following requirements in term of performance:

- Bandwidth: an efficient, fast, high throughput and low-latency connection of at least 10 Gbs.
- Computing: an efficient and managed queuing system to run and manage lots of jobs.
- Storage: easily horizontal-scalable storage resources, for long-term to be silent-corruption free.
- Easy Access: to a very large amount of data and metadata for different users and use cases.

and it will be compliant to the OAIS (Open Archival Information System) paradigm [RD10].

A distributed archive solution will be adopted for the physical deployment of the **Archive**, with three main nodes distributed among the following computing centers: INAF-OAR, INFN-Laboratori Nazionali di Frascati (LNF), and Space Science Data Center (SSDC) of the Italian Space Agency (ASI).

The Data Center has been preliminary dimensioned according to the expected MA data rate production which amount to: ~1 PB/yr of data produced at different reduction level (from DL0 up to DL3) plus some hundreds of TB for each MC production plus 5-10 TB of data per year due to the monitoring, logging, config and alarm archives.

At the present, the Data Center is composed of different machines with different roles; the bulk data storage and high-performance computing will be accomplished by 15 dedicated workstations whose resources are virtually aggregated together and provided as a single cluster.

The typical hardware configuration will be:



- 24 cores AMD/INTEL chipsets with 256 GB RAM each
- Redundant raid storage with 16 slots equipped with 16 (or more) TB SAS disks
- 2 mirrored SSD disks for OS
- redundant power modules
- optical SFP boards for IN/OUT connectivity at least 10Gbps

Moreover, it is foreseen to backup periodically Cherenkov camera and S13 raw data into external storage devices (tapes library) for disaster recovery. For higher level data products, backup data will be provided within the SSDC multi-wavelength archive.

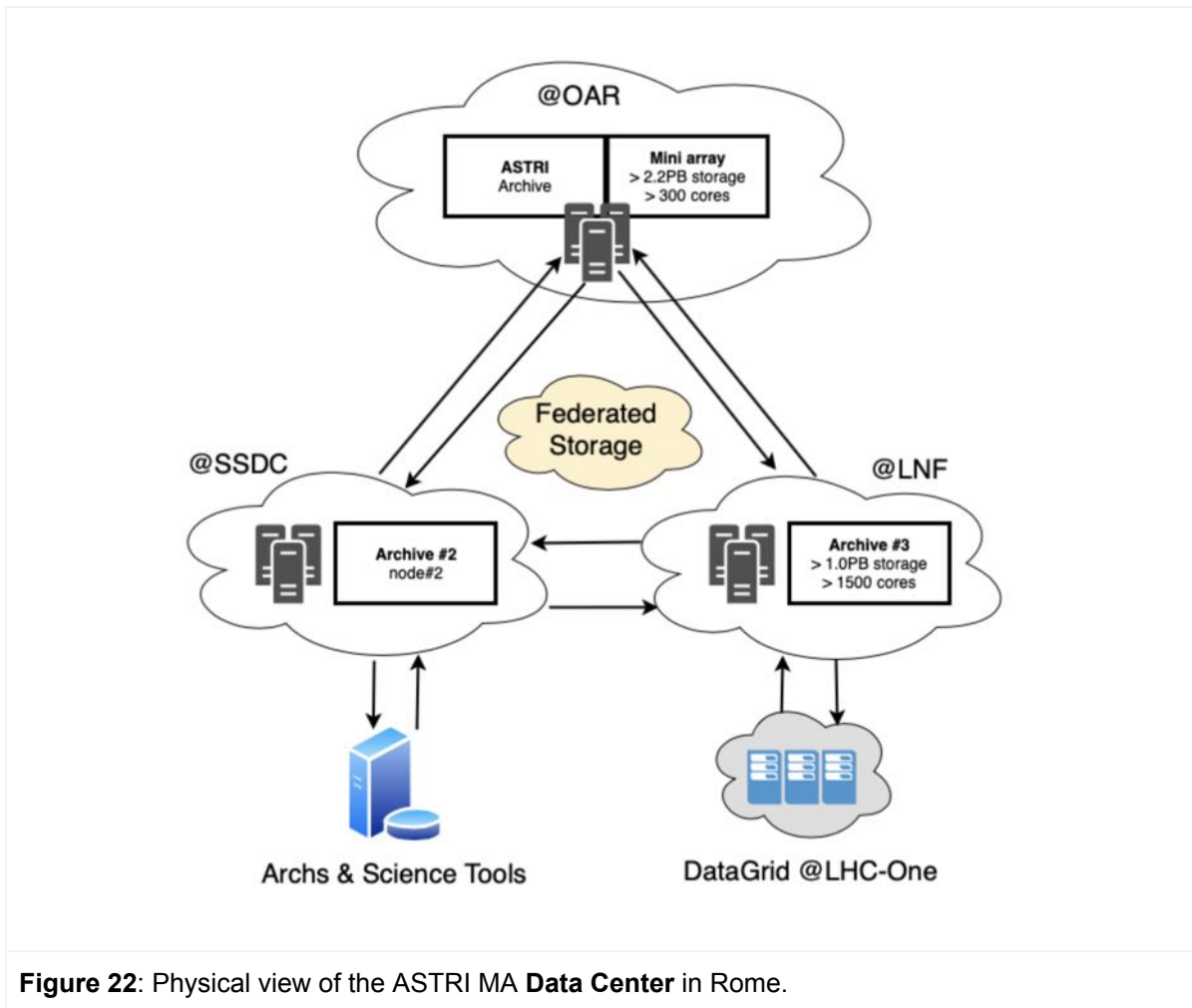
It is foreseen that the whole ASTRI MA scientific data processing will be performed on the cluster provided by the MA **Archive** (Fig. 22), while the MC simulations will be mainly executed on the LNF data-GRID node, within a dedicated ASTRI MA Virtual Organization. For that purpose, the LNF-INFN will be upgraded to provide ~1500 cores of computing power and ~1 PB of data storage.



**Figure 22:** Physical view of the ASTRI MA Data Center in Rome.

		<b>ASTRI Mini-Array</b> Astrofisica con Specchi a Tecnologia Replicante Italiana					
	<b>Code:</b> ASTRI-INAF-DES-2100-001	<b>Issue:</b>	2.5	<b>Date:</b>	Jun 18, 2021	<b>Page:</b>	45/119

### 3.8. Observing Cycle

The **MA Software System** is envisioned to handle the **observing cycle**, i.e. the end-to-end control and data flow system, which handles the information and operations required to conduct all tasks from the time a **Science User** creates an Observing Project until the resulting data are returned.

The global information and data flow have been derived from the Top Level Use Case document ([AD3]). In this section a description of the observing cycle and a link with the Top Level Use Cases is provided.

The **observing cycle** can be divided into the following main **phases**:

- 1) Observation preparation;
- 2) Observation execution;
- 3) Data Processing;
- 4) Dissemination.

A schematic representation of the global information flow is given in Fig. 23, where the main phases and related functions of the observing cycle are shown.

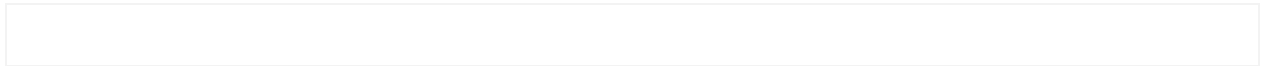

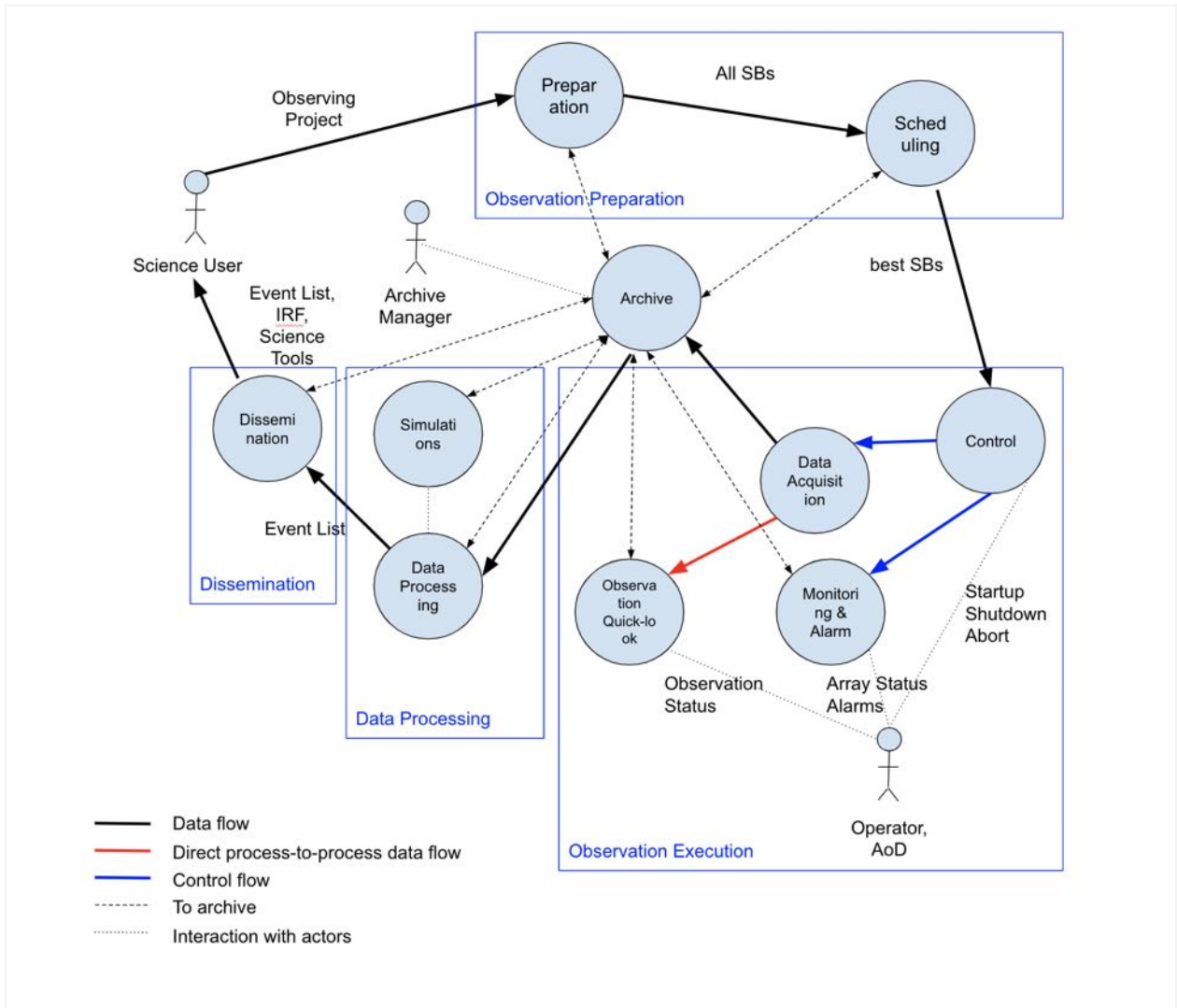

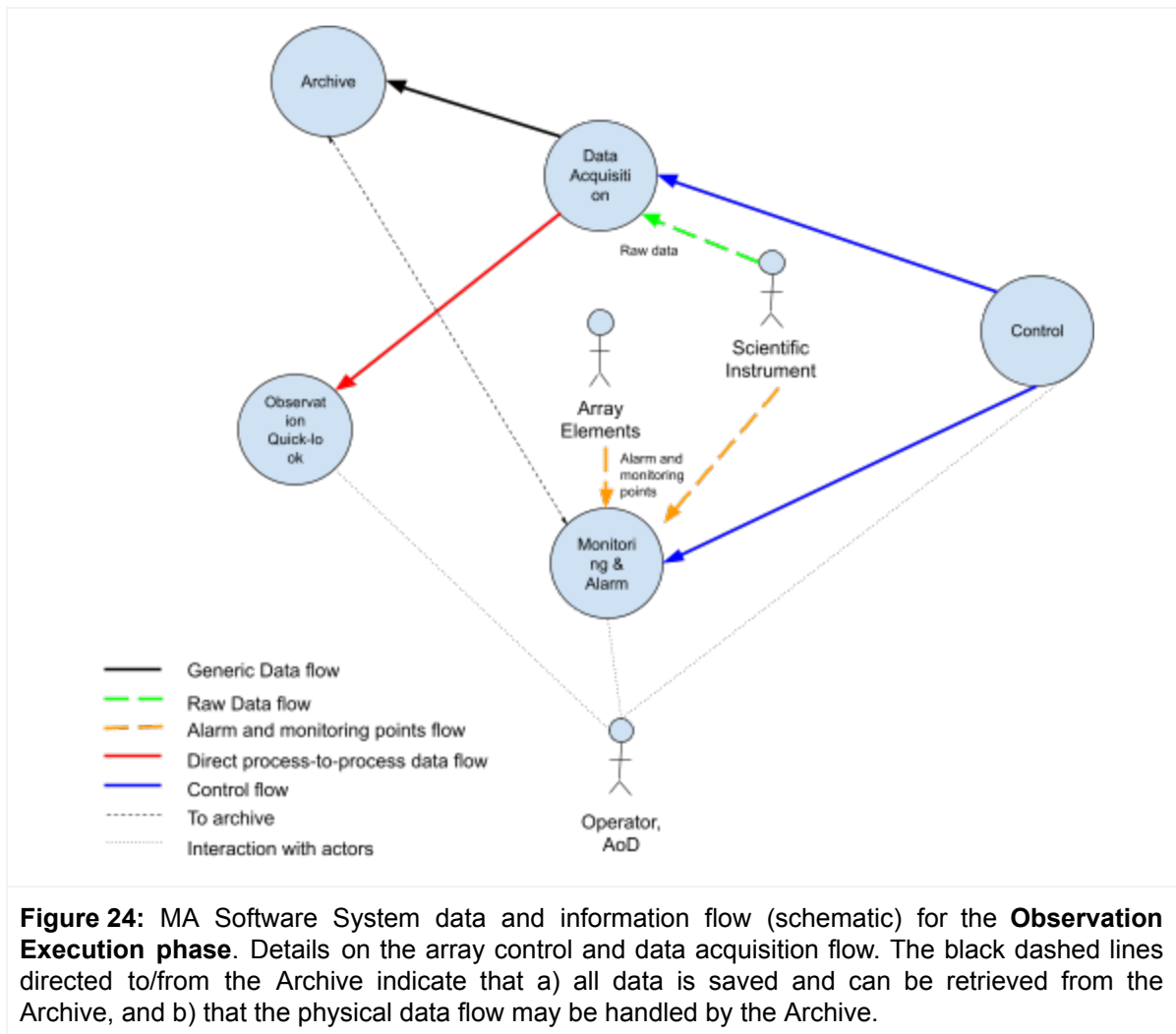

**Figure 23:** MA Software System data and information flow (schematic) with the four main phases. The outer solid black and red lines show the logical data flow, where the solid blue lines are control flow. Direct process-to-process communication is indicated with a red line. The **Archive Manager** is responsible for the quality and integrity of the archive. The dashed lines directed to/from the Archive indicate that a) all data is saved and can be retrieved from the Archive, and b) that the physical data flow may be handled by the Archive. A **Data Processing Manager** and a **Data Quality Scientist** in charge, respectively, of the data processing operations and of the quality of the data processing outputs, are not shown.



The **Science User** is interested in how an Observing Project flows through the different parts of the system as illustrated by the outer set of lines in Fig. 23, with some additional details in Fig. 24. The physical flow of the data goes to the Archive when this enables simplification of subsystem interfaces.

The **MA Software System** can manage the **observing cycle** from three different **perspectives**:

- 1) the **science user perspective**, i.e. the **Science User** (who submits the Observing Project), where the prime interest is to optimize the scientific return of the ASTRI MA System;
- 2) the **maintenance perspective**, where the prime interest is to ensure that optimum levels of availability and overall performance of the system are achieved;
- 3) the **observation perspective** (who manages the Observing Projects), where the prime interest is to optimize the efficiency of the observations.

		<b>ASTRI Mini-Array</b> Astrofisica con Specchi a Tecnologia Replicante Italiana					
	<b>Code:</b> ASTRI-INAF-DES-2100-001	<b>Issue:</b>	2.5	<b>Date:</b>	Jun 18, 2021	<b>Page:</b>	48/119

### 3.8.1. Science User perspective

The **Science User** initiates the observing cycle submitting an Observing Project (OP) for the **Observation Preparation phase**. After the Observing Project has been selected by the **MA Science Team**, it is turned into a set of Scheduling Blocks (SB) and stored in the **Archive** for scheduling (ref. ASTRI-UC-0-010). The execution of a SB (ref. ASTRI-UC-0-020, ASTRI-UC-0-070), i.e. the **Observation Execution phase** generates a set of raw data, which are both saved in the **Archive** (ref. ASTRI-UC-0-200) and, with the **Data Processing phase**, converted into an event list (ref. ASTRI-UC-0-090). **Data Processing System** is also responsible for producing the instrument response functions (IRFs) related to the OP (ref. ASTRI-UC-0-100). At the end of this process, the **Science User** receives the results of the observations linked to its OP, via **Data Dissemination phase**, in the form of event lists and IRFs, together with associated information (e.g., a summary of the Science Data Model) (ref. ASTRI-UC-0-110), and can download **Science Tools** (ref. ASTRI-UC-0-115) to perform scientific analysis (ref. ASTRI-UC-0-120).

Another way to access the data is through archival research (ref. ASTRI-UC-0-110), where an **Expert Science User**, part of the **MA Science Team**, requests for raw and low-level data directly to the **Archive**. Such access should be granted only in some specific cases, for well-motivated and agreed scientific and technical purposes, like the development of new calibration and reconstruction algorithms. Either way, no high-level scientific products derived from these raw and/or low level data shall be considered validated from the **MA Science Team** unless produced with the official data reduction and analysis tools provided by the **Data Processing** system and approved by the **Data Processing Manager**.

### 3.8.2. Maintenance perspective



The users of this perspective ensure that optimum levels of availability and overall performance of the MA System are achieved by **Configuration Manager** or **Maintenance Engineer**.

As data accumulate in the Archive, quality control performs trend analyses of them (ref. ASTRI-UC-0-025). The results can then be used to e.g., correct final data products or initiate maintenance actions. The functionality provided to this perspective is also useful for the definition of the Array configuration. Engineering analysis to follow trends in the hardware or diagnose problems that need the monitor data in its original, instrument-centric form, is part of this perspective.

### 3.8.3. Observation perspective

The MA System has a somewhat different view of the flow of information of the observing cycle, as its prime interest is to optimize the efficiency with which it can process Observing Projects and at the same time guarantee that all scientific requirements are fulfilled. This view is principally directed towards the **Archive**, which is the central repository for Observing Projects, data acquired and status and availability of elements. The main functional elements interact with the Archive to obtain and deliver data but some of them operate in an online mode. To ensure high global performance, each element must be optimized individually and have adequate access to the Archive.

**Observation Preparation phase.** Fundamental to the MA view is the Scheduling Block (SB), which is the smallest sequence of observing instructions that can be scheduled in a unified way. Once each SB has been defined, it is stored in the Archive and considered for execution whenever available observing conditions (visibility, weather forecasting) and array status conditions make its execution

		<b>ASTRI Mini-Array</b> Astrofisica con Specchi a Tecnologia Replicante Italiana					
	<b>Code:</b> ASTRI-INAF-DES-2100-001	<b>Issue:</b>	2.5	<b>Date:</b>	Jun 18, 2021	<b>Page:</b>	49/119

feasible. A long-term observation plan is prepared with the help of the **Observation Scheduler** tool (ref. ASTRI-UC-0-010).

**Observation Execution phase.** For the execution of a Scheduling Block (ref. ASTRI-UC-0-020, ASTRI-UC-0-070), the SB is divided into Observing Blocks and the **Central Control** executes the set of Scheduling Blocks as Runs, to be able to carry out the setups (with an appropriate set of configuration parameters), calibrations, and target observations necessary to ensure that the acquired data are properly calibrated and used in the construction of the final data product.

Operations at the MA observing site will be supervised remotely by the **Operator** via a remote console (HMI) that starts the array, checks the status of the array (ref. ASTRI-UC-0-025), checks environmental conditions (ref. ASTRI-UC-0-030) and atmosphere characterisation - e.g. NSB level (ref. ASTRI-UC-0-035), performs array calibration (ref. ASTRI-UC-0-050, ASTRI-UC-0-051), checks observation data quality (ref. ASTRI-UC-0-060), changes the schedule manually (e.g. changes in environmental conditions, atmosphere characterisation, array status can change the kinds of observations that can be carried out; the SBs are scheduled or stopped taking into current conditions, ref. ASTRI-UC-0-020, ASTRI-UC-0-070), check the status of devices (ref. ASTRI-UC-0-025), and administer other resources.

During the AIV and SVP phases and for maintenance activities, a local (on-site) control room shall be installed.

An **Astronomer-on-duty (AoD)** supports the observation and, manually, prepares Observing Projects (ref. ASTRI-UC-0-020) for manual ToO management.

An **Archive Manager** is responsible for the quality and integrity of the archive (ref. ASTRI-UC-0-200).

**Data Processing phase.** The **Data Processing** produces calibrated and reconstructed data (the final event list), applying whatever corrections are necessary (ref. ASTRI-UC-0-090). Monte Carlo **Simulations** are performed to optimise the reconstruction of the Cherenkov events (ref. ASTRI-UC-0-100). In case the results of the data processing indicate the need to modify the *long-term observation plan* to follow-up a particularly interesting state of a source, this shall be done manually (ref. ASTRI-UC-0-020).

**Data Dissemination phase.** Data and **Science Tools** are downloaded by the **Science User** for a scientific analysis of the Observing Projects (ref. ASTRI-UC-0-115). Science Tools can be used to produce images and/or spectra and detections of gamma-ray sources (ref. ASTRI-UC-0-120). High-level data and data products (event lists and IRFs) are released to the **MA Science Team** (ref. ASTRI-UC-0-110).



Storing all persistent information in the **Archive** makes the system less coupled so that these phases can work independently as long as they maintain the average flow to and from the Archive. This isolates operations from possible disturbances in other subsystems but makes the archive a critical component, which must have a very high availability.

## 4. Mini-Array Software System Overview

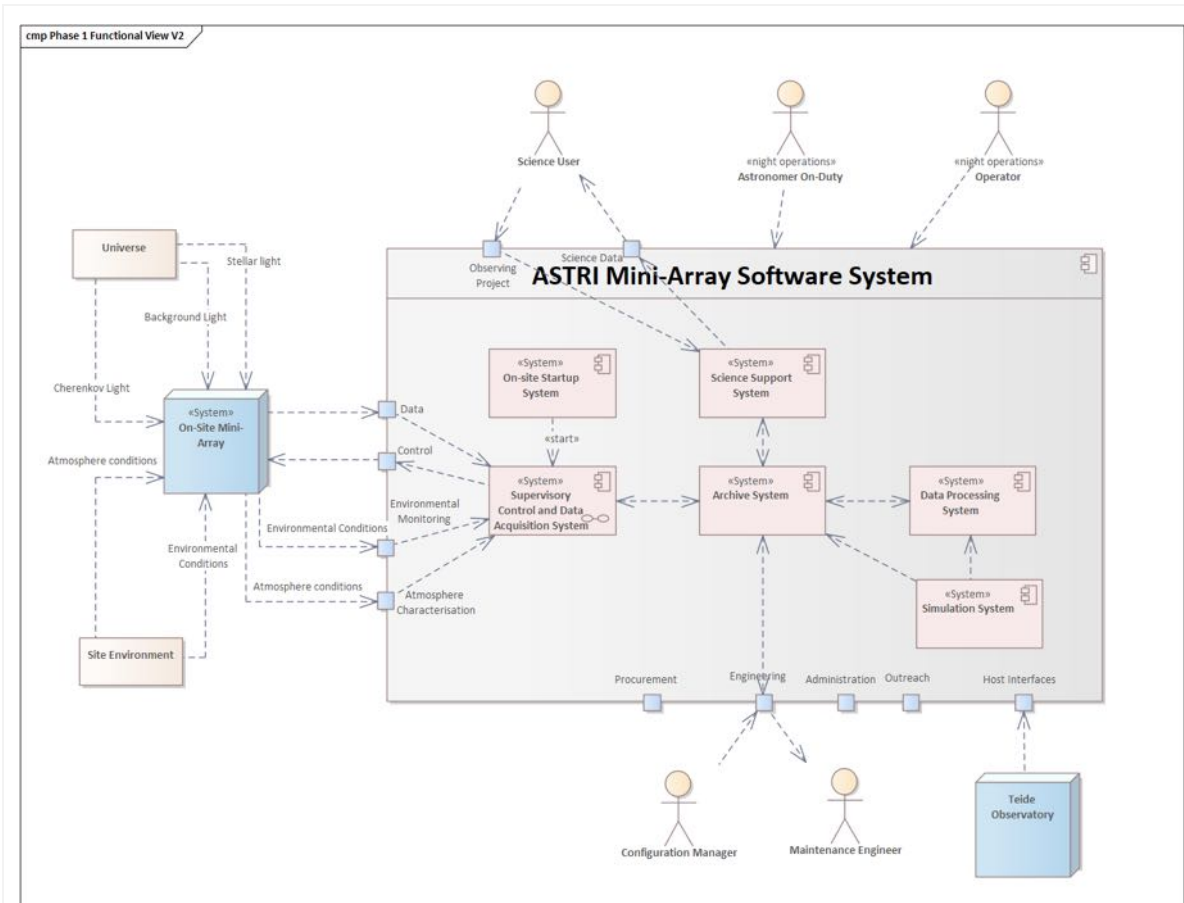
The general structure of the **MA Software System** (see Fig. 25) is derived from the use cases and data flow considerations and consists of the top-level systems described in this section and in Sect. 5.



**Figure 25:** Context view of the ASTRI MA Software System. The main software systems of the ASTRI MA System are shown.

		<b>ASTRI Mini-Array</b> Astrofisica con Specchi a Tecnologia Replicante Italiana					
	<b>Code:</b> ASTRI-INAF-DES-2100-001	<b>Issue:</b>	2.5	<b>Date:</b>	Jun 18, 2021	<b>Page:</b>	51/119

#### 4.1. ASTRI Mini-Array Software Main Systems

In this section is provided an overview of the main MA Software systems, with a short description of the main functionalities and a link of the systems with the observing cycle phases.

1. **Science Support System**: includes the Observing Projects, the observation plans preparation, the dissemination of scientific data and the science tools for their analysis. It is the main interface for **Science User** to the MA system and provides them with easy-to-use Science Support System HMI for the detailed specification of observations. The main products generated by this system are the Scheduling Blocks, which contain all the information required to perform the corresponding observations. The Science Support System also contains the Science Gateway, a web interface that shall be used to access high-level science-ready data and data products produced by the Data Processing System.

This system supports the following observing cycle phases:

- **Observation Preparation phase**
- **Dissemination phase**

The main functions are:



- **Observing Project Handler**: to submit Observing Projects, to store the long-term observation plans and to select the short-term observation plans for the next night;
- **Observation Scheduler**: to support the preparation of long-term observation plans, short-term observation plans and Observing Project preparation;
- **Science Gateway**: to retrieve science-ready data, science tools and tools to support the Observing Project preparation.

2. **SCADA (Supervisory Control and Data Acquisition) System**: a software system controlling all the operations carried out at the MA site. SCADA has a Central Control System which interfaces and communicates with all assemblies and dedicated software installed at the site. It is responsible for the execution of the Scheduling Blocks to perform observations. SCADA shall normally be supervised by the **Operator** but performs the operations in an automated way. It shall provide scientific data, logging, monitoring, alarm, and online observation quality information to help assess the quality of data during the acquisition.

This system supports the day and night observing cycle operations (**Observation Execution phase**) and **Maintenance phases**.

The main functions are:

- **Central Control System**, coordinates the sequence of operations, coordinating the control systems and collectors, and the sequences of startup, shutdown and configuration of the on-site MA Systems, checks the status of the assemblies, get the Scheduling Blocks and select the Observing Block; interprets the Observing Mode specified to command the telescopes and other subsystems; a Data Capture that save the information associated with the execution of an Observing Block necessary to perform the scientific data processing of the acquired data;
- **Control system**, to control, monitor, manage alarms and the status of the telescope (**Telescope Control System**), of the assemblies used to characterise the atmosphere (**Atmosphere Characterisation Control System**), of the calibration system (**Array Calibration Control System**)
- **Collectors**, to monitor, determine alarms and the status of environmental devices (**Environmental Monitoring System Collector**), of the ICT system (**On-site ICT System**)

		<b>ASTRI Mini-Array</b> Astrofisica con Specchi a Tecnologia Replicante Italiana					
	<b>Code:</b> ASTRI-INAF-DES-2100-001	<b>Issue:</b> 2.5	<b>Date:</b> Jun 18, 2021	<b>Page:</b> 52/119			

- **Collector**), of the power system (**Power Management System Collector**), of the Safe and Security System (**Safety and Security System Collector**);
- **Array Data Acquisition System** acquires Cherenkov Cameras and Stellar Intensity Interferometry Instruments;
- **Online Observation Quality System** focuses on ongoing problems and status of the observations;
- **Logging System, Monitoring System** and **Alarm System** monitor the overall performance of the systems through the acquisition of environmental, monitoring and logging points and alarms from instruments and generates status reports or notifications to the **Operator**;
- **Operator HMI**: the user interface for the **Operator**.

3. **Data Processing System**: the acquired scientific data are calibrated, reduced and analysed by this subsystem, which also checks the quality of the final data products. Its primary role is to process data, retrieved from the Archive, as soon as enough data has been acquired to make such reduction meaningful. Typically, processing will be performed on data sets arising from a Scheduling Block. This system supports the observing cycle **Data Processing phase**.

The main functions are:

1. **Stereo Event Builder**: perform the off-line software stereo array trigger of Cherenkov data;
2. **Cherenkov Data Pipeline**: data calibration, reconstruction, analysis, and scientific analysis of Cherenkov data;
3. **Science Tools**: DL3 data shall be analysed by means of science analysis tools to get the final science products.
4. **Intensity Interferometry Data Pipeline**: data reconstruction and scientific analysis of Stellar Intensity Interferometry data.

4. **Archive System**: provides a central repository for all persistent information of the MA system such as Observing Projects, observation plans, raw and reduced scientific data, device monitor data, MA system configuration data (past, present and planned), logs of all operations and schedules.

5. **Simulation System**: provides simulated scientific data for the development of reconstruction algorithms and for the characterisation of real observations.

6. **On-site Startup System**: shall manage the sequence of the startup and shutdown of the critical on-site systems.

## 4.2. Operation of the MA software system

In this section is presented an analysis of the Top Level Use Cases to provide a skeleton of the architectural process view. Fig. 26 shows a collaboration diagram which describes the workflow and the main operation of the MA software system. Human actors are defined in [AD3].

The main software systems work together in the following way: the **Science Support System** is responsible for the management of Observing Projects submitted by **Science User** and the associated Scheduling Blocks **(1)**, stored in the **Archive System (1.1)** as observation plans.

The **SCADA System** performs startup of the MA, controls the array, acquires data, helps the **Operator** to perform an observation, checks quality of the observation, manages alarms, monitors hardware, performs an environmental condition and atmosphere characterisation checks.



At the beginning of the night the validated short-term observation plan with all the relevant information (target and pointing coords, observing mode, Observing Block duration, ...) is uploaded from the **Science Archive** in either automated or manual way but, in both cases, under the supervision of the **Operator**.

The selection of an observation is performed automatically by the **Central Control System** or manually by the **Operator (2)**, that makes a quick cross-check of the status of the array and the environmental conditions through the **Operator HMI**, selecting the Scheduling Block to be executed in manual mode or setting the **Central Control System** in automated mode **(2.1)**. The observation is managed by the **Central Control System** that fetches the Scheduling Block from the Archive **(2.2)**. The **Central Control System** configures the array assemblies, starts the **Data Acquisition (2.4)**, and the **Online Observation Quality System (2.5)**. The **Alarm System** and the **Monitoring System** have already been started.

When the systems are ready the **Operator** starts the observation **(3)**, and the **Central Control System** manages the list of Observing Blocks in an automated way. Each Observing Block becomes a Run with an associated runID. During the observation, the **Data Acquisition** acquires and saves raw data in the **Local Bulk Repository (3.1)**, while the **Online Observation Quality** system focuses on ongoing problems on data quality **(3.2)**. The **Central Control System** also prepares the Science Data Model during the observation (see [AD2]) with the **Data Capture**, collecting all the engineering and auxiliary information needed by the Data Processing System to reduce and analyze the scientific MA raw data.

During the observation, the **Operator** checks the status of the observation through the **Operator HMI**. The **Central Control System** sends the information about the status of the observation **(3.3)**, providing feedback to the **Operator**. The **Online Observation Quality System** sends observation data quality information to the **Operator HMI (3.2)**. **Logging System (3.4)** and **Monitoring System (3.5)** send information to the **Operator HMI**. **Alarm System** sends alarms to the **Operator HMI (3.6)**.



When a Run is finished **(4)**, the Science Data Model **(4.1)** and the raw data **(4.2)** are transferred to the Bulk Archive. A short-term analysis is performed at the end of the data transfer of a Run **(4.3)**, with the aim to produce preliminary science products, which will be stored in the **Archive System (4.4)**.

When data is ready in the off-site Archive, the long-term data analysis is started by the **Data Processing Manager (5)**. The **Data Processing System** pipeline retrieves raw data and metadata (the Science Data Model), as well as calibration coefficients (CAL1), look-up-tables (LUTs) and instrument response functions (IRFs) needed for Cherenkov data characterization and scientific analysis, from the **Archive System (5.1)** and **(5.2)** and performs the full data reduction. The **Data Processing System** pipeline generates the final science-ready data and automatic MA science products and stores them in the **Archive System (5.3)**. Ahead of the Cherenkov data analysis, a stereo event building procedure is executed by means of an offline software array trigger. This step is essential to fully exploit the stereoscopic capability of the array.

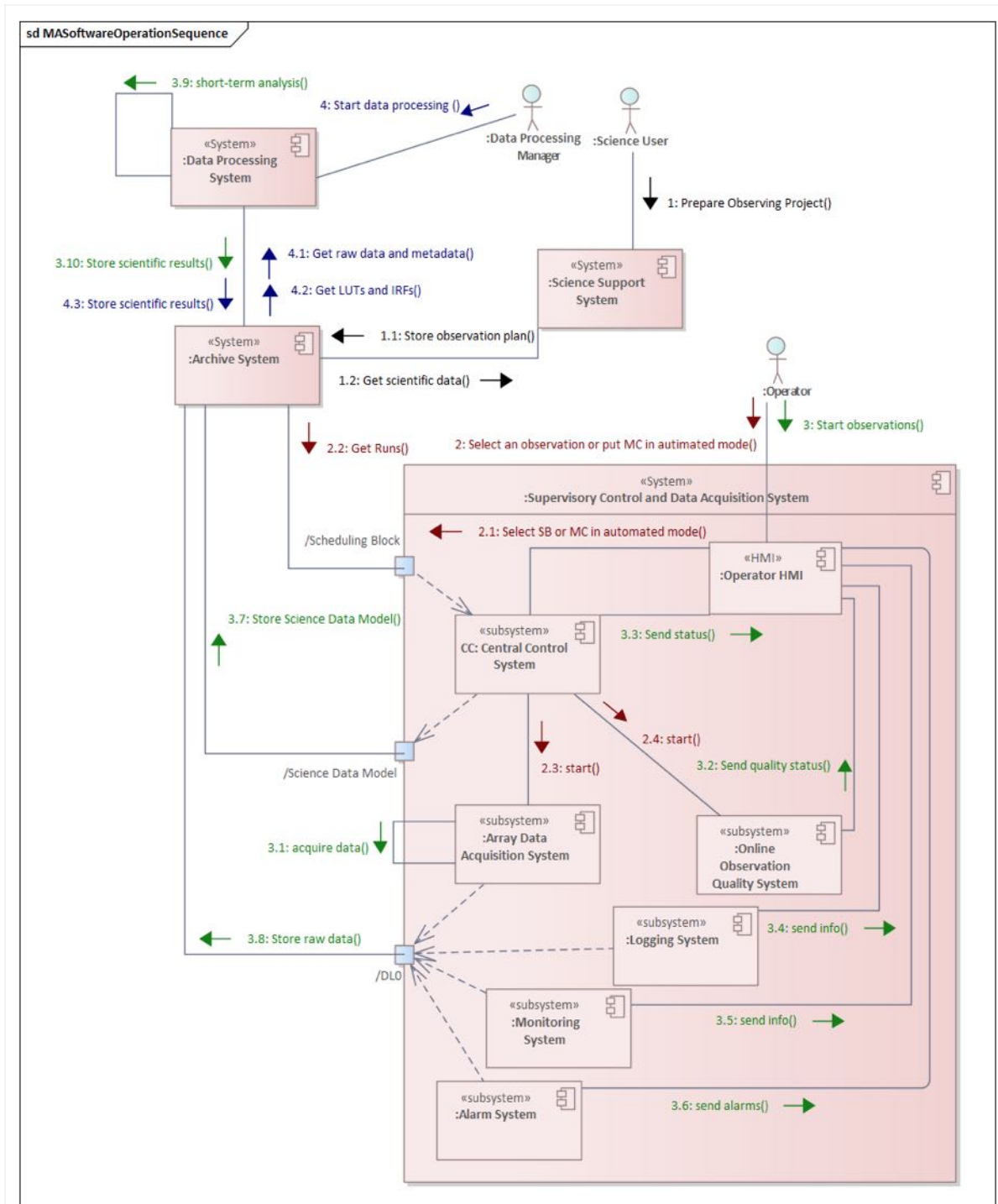
When science-ready data and science products are ready, they are made available from the **Archive System** by the **Science Support System** to the **Science User (1.2)**.



**Figure 26:** Operations of the MA Software System. The numbered arrows indicate steps in the creation and processing of an Observing Project through to data reduction and storage in the Archive. See text for more details. Path (5) is not shown.

		<b>ASTRI Mini-Array</b> Astrofisica con Specchi a Tecnologia Replicante Italiana					
	<b>Code:</b> ASTRI-INAF-DES-2100-001	<b>Issue:</b>	2.5	<b>Date:</b>	Jun 18, 2021	<b>Page:</b>	55/119

### 4.3. Telescope domain and science domain

The software that makes up the **ASTRI MA System** can be divided into **telescope domain** and the **science domain**. A detailed description of these two domains is given in [AD2], where a classification of the domains is based on data models.

These two domains can be used to classify the various software subsystems that make up the **MA Software System**. The classification is based on data models connected with each software system (details are provided in Sect. 5).

The **Science Support** is in the science domain.

The **Central Control System**, the **Array Data Acquisition**, the **Alarm System**, the **Logging System** and the **Monitoring System**, the **Telescope Control System** on the other hand, are clearly in the telescope domain. The actual execution of a Scheduling Block by the Central Control consists of the execution of a sequential series of Observing Blocks. The **Online Observation Quality System** results are connected with an Observing Block but show the status of the current observation, and for this reason this system has aspects of both domains.

The **Data Capture**, part of the **Central Control System** (see Sect. [5.2.7.](#)) provides the bridge between these two domains. The Data capture takes the instrument-centric, time-ordered stream of data, collects and extracts those items needed in the science domain, and re-organizes them to be useful in data processing. Practically, it is responsible for collecting the auxiliary data associated with the Observing Block execution (a Run). These links to the acquired data, the observation and the auxiliary data are called **Science Data Model** (see [AD2]) and are necessary for the downstream subsystems to interpret the scientific data as they arrive.

The Science Data Model is the link between the two domains.

**Data Processing**, whose purpose is to produce calibrated data products, is in the science domain. The acquired data may be accumulated over many Runs and the Data Processing pipeline manages and merges the results that require the data from different Runs. One of the inputs of the Data Processing system is the Science Data Model.

## 5. Software Architecture functional decomposition

### 5.1. On-Site Startup Systems

[ASTRI-9.7.0.0-2010] The **On-Site Startup Systems** (or **Startup Systems**) shall manage the sequence of the startup and shutdown of the **critical on-site systems**:

- **Power Management System** shall start up all the systems installed on the field at Teide (e.g. Telescopes). See Sect. 3.6.5.
- **Environmental Monitoring System** (Sect. 3.6.2).
- **Safety and Security System** (Sect. 3.6.6).
- **On-Site ICT System** (Sect. 3.6.7), including the **Time Synchronization and Distribution System**.

[ASTRI-9.7.0.0-2020] The **Startup Systems** shall start the **SCADA/Central Control System** and the **SCADA/Operator HMI** after the critical on-site systems.

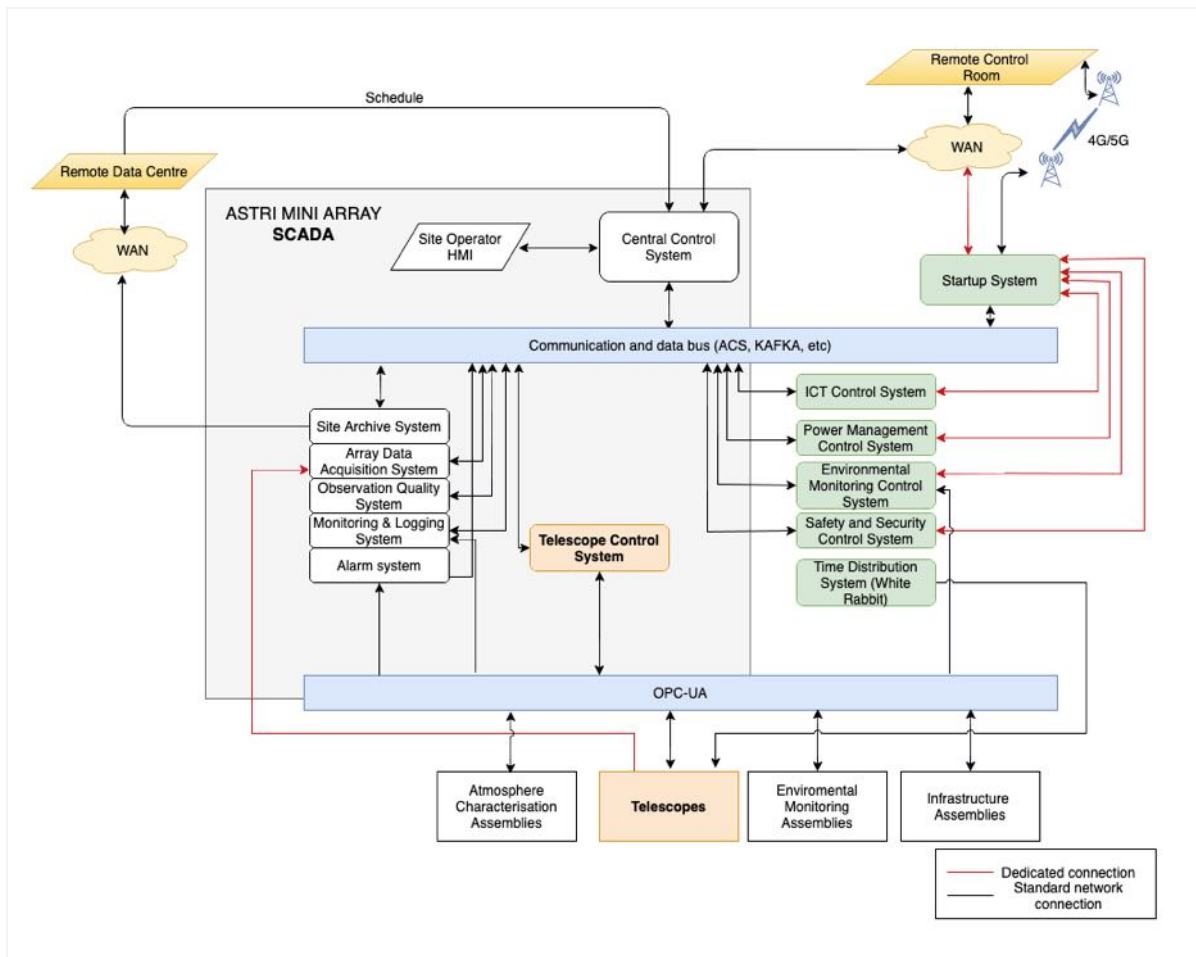

**Figure 27:** Data and control flow between the main subsystems of the SCADA System and the Startup System.





## ASTRI Mini-Array

Astrofisica con Specchi a Tecnologia Replicante Italiana



Code: ASTRI-INAF-DES-2100-001

Issue:

2.5

Date:

Jun 18, 2021

Page:

58/119

**[ASTRI-9.7.0.0-2080]** The **Startup System** shall be accessible by a local/remote **Operator** through a simple User Interface, the **Startup System GUI** running on PC/PLC that starts and stops all controlled systems.

**[ASTRI-9.7.0.0-2090]** The **Startup System** shall grant access only to an **Operator** that followed a dedicated training cycle.

## 5.2. Supervisory Control and Data Acquisition system (SCADA)

The **Supervisory Control and Data Acquisition system (SCADA)** system shall manage startup, shutdown, configuration, control of all **site assemblies** and **subsystems**; collect monitoring points; manage alarms raised by any assembly; check the health status of all systems and acquire scientific data.

All ASTRI MA elements controlled and monitored by SCADA have the <<assembly>>, <<subsystem>> or <<device>> stereotypes.

The types of interconnection are dashed lines and marked with the following stereotypes (nodes are shown in Fig. 5):

- The <<telemetry>> stereotype represents all monitoring points (MON node), alarms, errors (ERR node), logs (LOG node), and status information (see Sect. [3.5.1.](#)).
- The <<control>> stereotype represents the control flow, i.e. startup/shutdown, command and configuration (see Sect. [3.5.1.](#)).
- The <<data>> stereotype represents the data flow between the MA subsystems and the SCADA system. The data categories that can be acquired by the SCADA system are described in [AD2] and are:
  - Cherenkov Camera Data
  - Stellar Intensity Interferometry Instrument Data
  - Atmosphere Characterisation data
  - Environmental Monitoring Data
  - Calibration Data

The generic <<flow>> stereotype indicates an exchange of information between components and can be <<telemetry>> or <<data>>.

**Reading points** have <<telemetry>> and <<data>> stereotypes.

### 5.2.1. SCADA Context diagram

Fig. 29 shows the context diagram of the SCADA System. In the context diagram the main subsystems that interact with the SCADA system are reported, without the detail of the assemblies. All assemblies of the MA system are connected with the SCADA system.

The short-term observation plan for the observing night (a list of Scheduling Blocks) is retrieved from the **Science Archive** in an automated mode. A manual mode is foreseen. The result of an observing night is stored in the off-site Archive, where the data are saved in the **Bulk Archive** and the Science Data Model in the **Science Archive**. The data transfer from the on-site Archive System to the off-site Archive System is performed in an automated way.

The **Operator** and the **Astronomer-on-duty** interact with the system during the observation (ref ASTRI-UC-0-20 and ASTRI-UC-0-70 [AD3]).

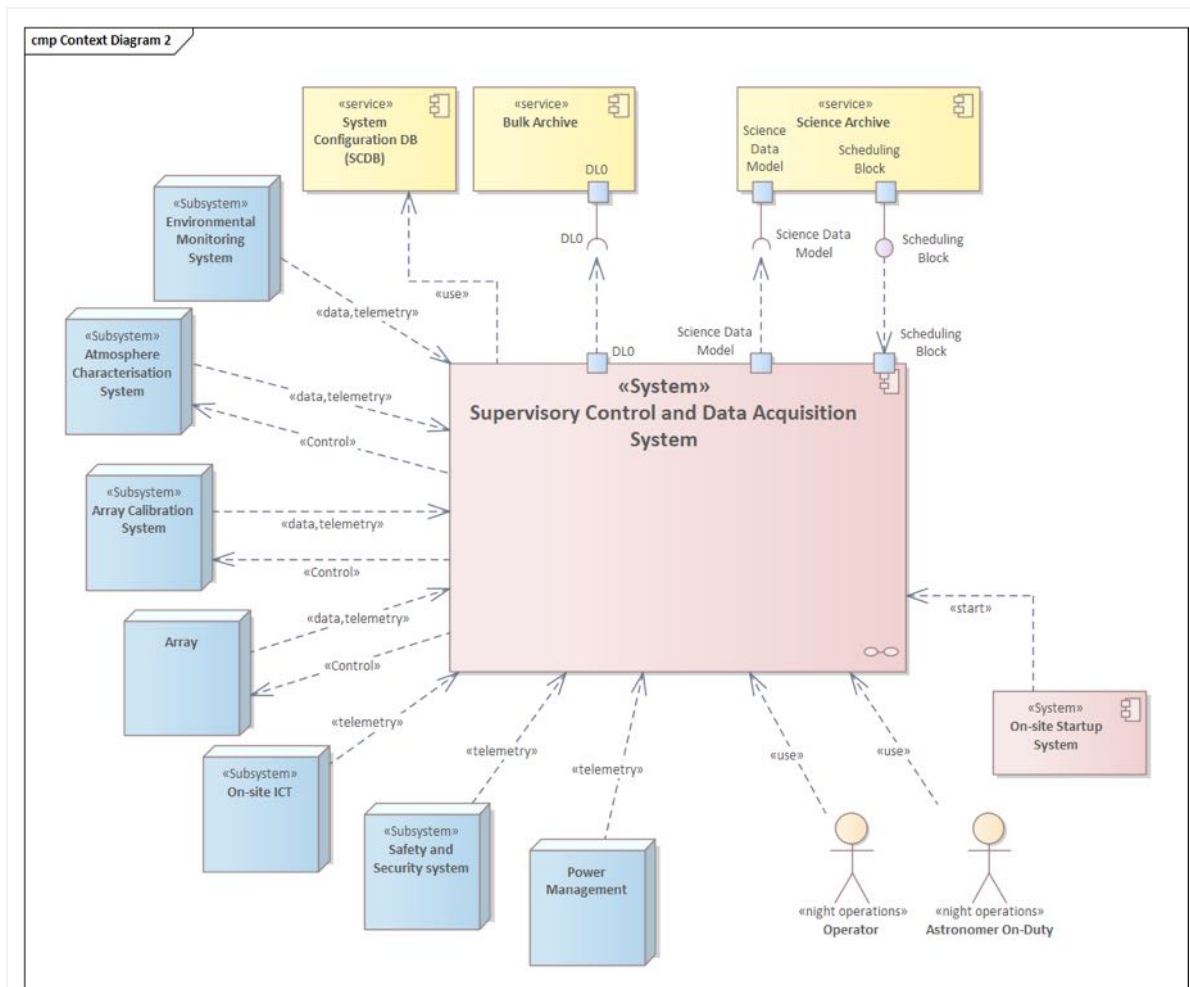

**Figure 29:** SCADA context diagram.



### 5.2.2. SCADA main concepts

The **SCADA** system has many **SCADA Control Software** (or **Control System**) that interface with all the functionalities of the **Local Control Software** via an OPC-UA interface.

The **Local Control Software** has the server-side OPC-UA interface, SCADA has the client-side.

The SCADA **Control Software** (or **Control System**) shall manage, at system/subsystem level:

1. startup and shutdown;
2. command;
3. configuration;
4. the **system/subsystem/assembly state machine**;
5. acquire <<telemetry>> info needed to perform the SCADA functionalities;
6. generate warning or critical events;
7. acquire <<data>> needed for SCADA functionalities.

		<b>ASTRI Mini-Array</b> Astrofisica con Specchi a Tecnologia Replicante Italiana					
	<b>Code:</b> ASTRI-INAF-DES-2100-001	<b>Issue:</b>	2.5	<b>Date:</b>	Jun 18, 2021	<b>Page:</b>	61/119

The **SCADA** system has also many **Collectors** that interface with all the functionalities of the **Local Control Software** via an OPC-UA interface, but the Collector has only the capability to determine the state machine of the assemblies, acquires monitoring points and alarms of all parts of the system/assembly, in particular at system/subsystem level shall,

1. determine the **system/subsystem state machine** and/or **assembly state machine**, reading the appropriate information;
2. acquire <<telemetry>> info needed to perform the SCADA functionalities;
3. generate warning or critical events needed for SCADA functionalities;
4. acquire <<data>> needed for SCADA functionalities.

The **Control Software** and **Collectors** shall map the state machine of the assembly with the state machine managed by **Local Control Software**. If a **Control Software** or **Collector** manages more than one assembly, each assembly is managed by an assembly **Supervisor**, a software component that interfaces with the hardware elements and that manages the composition of the **assembly state machines**.

Each SCADA subsystem has a **Subsystem Manager**, an ACS software component that provides an interface of a SCADA subsystem with the rest of the SCADA system (including the **Central Control System**) and manages the lifecycle of the SCADA software subsystem, in particular it manages the **software component state machine**.

**Control Software** and **Collectors** are connected with the **Operator HMI**.

The overall ASTRI MA on-site software is organized into 5 logical layers (see Fig. 30):

- layer 0, assembly: an assembly represents a collection of hardware (sensors, actuators);
- layer 1, Local Control Software;
- layer 2, OPC-UA interface with SCADA system;
- layer 3 and 4 are part of the SCADA system:
  - layer 3: **control software** performs tasks of control and synchronization of the actions of the assemblies to accomplish the tasks. It must also manage the state machine of the assemblies, detect abnormal conditions or alarms from assemblies, and acquire monitoring points useful to detect events and health of the assemblies. **Collector** has only the capability to determine the state machine of the assemblies reading appropriate information, detect abnormal conditions or alarms from assemblies, and acquire monitoring points useful to detect events and health of the assemblies. **Control software** or **Collectors** could have **Supervisors**.
  - layer 4: **Central Control System**, is the layer that coordinates all the subsystem of the MA system

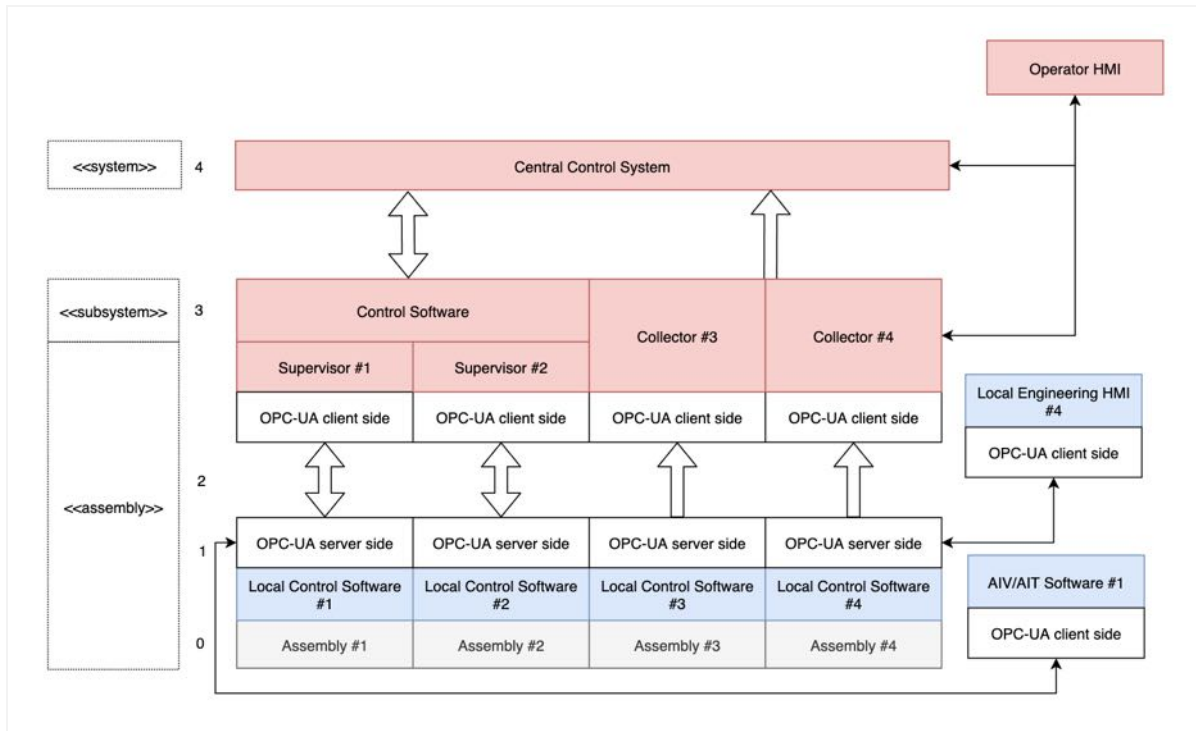

See Fig. 31 for an example of the Control System hierarchy implemented using ACS framework [RD11] and OPC-UA communication protocol [RD12].

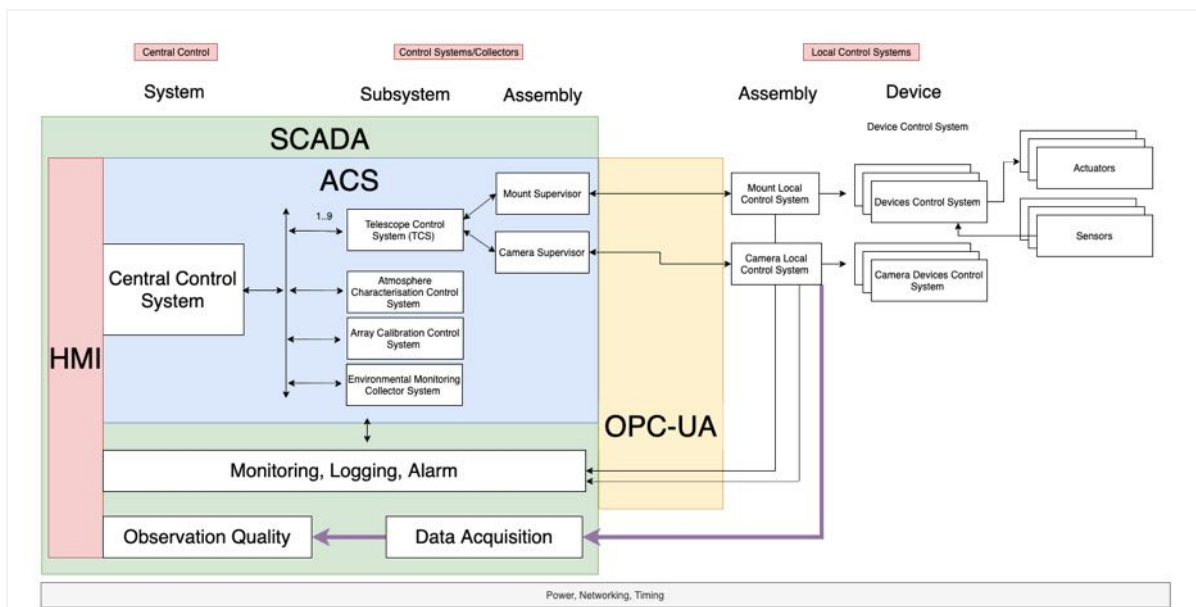

**Figure 30:** ASTRI MA on-site software logical layers.



**Figure 31:** An example of systems, subsystems, assemblies, devices hierarchy, with Control Systems. The SCADA system interacts with Local Control Systems that provide OPC-UA server interfaces. SCADA has only OPC-UA clients. Alma Common Software (ACS) is the general framework for the “OPC-UA client side” and to monitor all software subsystems.

		<b>ASTRI Mini-Array</b> Astrofisica con Specchi a Tecnologia Replicante Italiana					
	<b>Code:</b> ASTRI-INAF-DES-2100-001	<b>Issue:</b>	2.5	<b>Date:</b>	Jun 18, 2021	<b>Page:</b>	63/119

### 5.2.3. Software Framework and Middleware

The ALMA Common Software (ACS) [RD11] shall serve as the software framework and middleware for the SCADA system. ACS has been used successfully in an analogous observatory control system, namely ALMA, which manages an array of 66 antennas at a site, on the Chajnantor plateau in Chile at 5000 meter elevation, even more remote than the Mini-Array's site at Teide.

ACS has also been used by the ASTRI project in the development and operation of the prototype 2M-SST telescope on Mt. Etna in Sicily. Most of the Mini-Array's software developers in INAF are therefore familiar with the use of ACS.

ACS provides a framework in the form of a container-component paradigm based on CORBA for the distributed development and execution of the software system. It enables the separation of functional and technical concerns, so that application developers can concentrate on functional (aka "business") concerns, while using the common technical facilities provided by ACS, for example:

1. Location transparency: software components can be moved from one host to another at runtime without changes to interfaces or software implementation.
2. Transparent communication between components written in any of the three supported software languages: Java, C++ and Python.
3. Standard Interface Definition Language (CORBA IDL).
4. Centralized logging system with language-standard interfaces.
5. Publish-subscribe facility in the form of the CORBA Notification Service.
6. Programming model for monitoring and control of hardware devices.
7. Common software build system.

ACS as *common* software shall be used in all SCADA code. The intention is to standardize across the SCADA code base, as much as possible, the implementation of similar tasks, *i.e.*, "do the same thing in the same way." During the lifetime of the Mini-Array, different developers will be entrusted with updates and maintenance of the SCADA software. Most will be confronted with code that they have not developed or even seen before being tasked with debugging or enhancing it; when used consistently, ACS idioms can flatten their learning curve and contribute to the maintainability of the software.

The ALMA observatory continues to maintain and enhance ACS, which is crucial to its operations. With its projected multi-decade lifetime, a current version will be available throughout the 10 years lifetime of the ASTRI Mini-Array.

### 5.2.4. SCADA main functional requirements

**[ASTRI-9.1.0.0-2000]** The **Supervisory Control and Data Acquisition (SCADA)** system of the ASTRI MA System shall supervise and control all the operations of the subsystems, assemblies and devices at Array Observing Site, including the startup and shutdown of the Observing Subsystems.

**[ASTRI-9.1.0.0-2002]** **SCADA** shall execute scientific observations, from input of the Scheduling Blocks to the execution of the observations organised in a sequence of Runs.

**[ASTRI-9.1.0.0-2004]** The **SCADA** System shall acquire the data produced by the instruments installed on the telescopes, by the **Atmosphere Characterisation System**, and by the **Environmental Monitoring System**. The data are archived and transmitted to the temporary on-site repository and to the permanent off-site **Archive System** in Italy.



**[ASTRI-9.1.0.0-2006] SCADA** shall switch-on, switch-off, control, configure, get status and manage the subsystem state machine and assembly state machine, acquire monitoring points that can generate warning or critical event notifications, errors and alarms of the assemblies of the ASTRI Mini-Array Observing Subsystems, acquire <<data>> needed for SCADA functionalities, with the following SCADA **control software**:

- **Atmosphere Characterisation Control System**: for all assemblies of the Atmosphere Characterisation System;
- **Array Calibration Control System**: for all assemblies of the Array Calibration System;
- **Telescope Control Systems**: for all assemblies of the Telescope System.

**[ASTRI-9.1.0.0-2008] SCADA** shall get status and determine the subsystem state machine and assembly state machine reading appropriate information, acquire monitoring points that can generate warning or critical event notifications, errors and alarms of the assemblies of the ASTRI Mini-Array with the following SCADA **collectors**:

- **Environmental Monitoring System Collector**: for all assemblies of the Environmental Monitoring System;
- **On-Site ICT System Collector**: for all assemblies of the on-site ICT System;
- **Power Management System Collector**: for all assemblies of the Power Management System;
- **Safety and Security System Collector**: for all assemblies of the Safety and Security System.

**[ASTRI-9.1.0.0-2010] SCADA** shall provide a mapping between the assembly state machine and state machine managed by Local Control Systems and shall manage the system state machines as a composition of the assemblies state machines.

**[ASTRI-9.1.0.0-2012]** A **Central Control System** shall coordinate all the operations of the ASTRI Mini-Array at the observing site, in particular shall coordinate all control software and collectors activities. The **Central Control System** shall be a higher level control software.

**[ASTRI-9.1.0.0-2014]** A **Monitoring System** shall acquire all monitoring points of all the ASTRI Mini-Array on-site assemblies.

**[ASTRI-9.1.0.0-2016]** A **Logging System** shall acquire all logging information of all the ASTRI Mini-Array on-site assemblies and software subsystems.



**[ASTRI-9.1.0.0-2018]** The **Array Data Acquisition System** system shall acquire the data produced by the Cherenkov Cameras and by the S13 instruments.

**[ASTRI-9.1.0.0-2020]** The **Online Observation Quality System** shall perform the data quality checks on the acquired data during the data acquisition to provide immediate feedback.

**[ASTRI-9.1.0.0-2022]** The **SCADA** System shall be installed at the Teide MA site.

**[ASTRI-9.1.0.0-2024]** An **Alarm System** shall generate alarm notifications for the **Operator**.

The following cross-cutting requirements are applicable to all SCADA subsystems. Since this functionality is ubiquitous in the system, and may be used anywhere in the software and/or hardware, it will not be shown as a rule in the diagrams that follow, since explicitly including it would clutter the

		<b>ASTRI Mini-Array</b> <b>Astrofisica con Specchi a Tecnologia Replicante Italiana</b>					
	<b>Code:</b> ASTRI-INAF-DES-2100-001	<b>Issue:</b>	2.5	<b>Date:</b>	Jun 18, 2021	<b>Page:</b>	65/119

diagrams, making their specifics more difficult to understand. The presence of the logging and alarm facilities, therefore, should be understood to be implicit in every diagram.

**[ASTRI-9.1.0.0-2026]** Every software and hardware subsystems in the SCADA system shall be able to use ACS facilities to **log** actions or events that are deemed important for later examination or troubleshooting, as well as **alarms**, which are events or states that require intervention by the **Operator**.

**[ASTRI-9.1.0.0-2028]** The interface between the **SCADA** system and the **Local Control Software** of the controlled and monitored assemblies shall be handled via OPC-UA [RD12]. SCADA implements the client-side of the OPC-UA interface and all assemblies implement the server-side.

**[ASTRI-9.1.0.0-2030]** **SCADA** shall get the configuration of subsystems and assemblies from the **System Configuration DB (SCDB)**.

### 5.2.5. SCADA architectural communication patterns

In this section the architectural communication patterns of the SCADA system are described. There is a *Control Software* that (both) controls and monitors the assemblies, or a *Collector* that only monitors the assemblies.

5.2.5.1. Communication pattern #1: identification of an assembly event with a control software/collector

A general overview of the pattern #1 is given in Fig. 32. Main guidelines:

1. Only one SCADA subsystem, a Control Software or a Collector, shall identify the condition (abnormal/fault) to generate the event. If a Control Software/Collector is not present, this responsibility is given to the **Monitoring System**:
  - a. the SCADA subsystem that generates the event could also decide corrective actions in an automated way.
2. An event has an associated SEVERITY.
3. The event is notified to other SCADA subsystem that can generate new events:
  - a. the event is sent to any subsystem that requires it using a publisher/subscriber mechanism. E.g. the **Central Control System** could receive the event;
  - b. the **Logging System** saves the event in the **Log Archive**;
  - c. the **Alarm System** manages alarm conditions for the generation of the alarm from this event:
    - i. the Alarm System can read other monitoring points if needed;
    - ii. the alarm is for the **Operator**;
    - iii. avoid the generation of the same event with the Alarm System (avoid duplications).
4. The **Monitoring System** shall save all monitoring points in the **Monitoring Archive**.
5. The **Central Control System** could generate a new event at a higher level that follows the same pattern.

The systems that have a Control Software are:

- **Telescope Control System**
- **Atmosphere Characterisation System**
- **Array calibration system.**

The systems that have a Collector are:

- **Environmental Monitoring System**
- Infrastructure
  - **Power Management System**
- Information Communication Technology
  - **On-site ICT System**
- Protection Subsystems
  - **Safety and Security System**

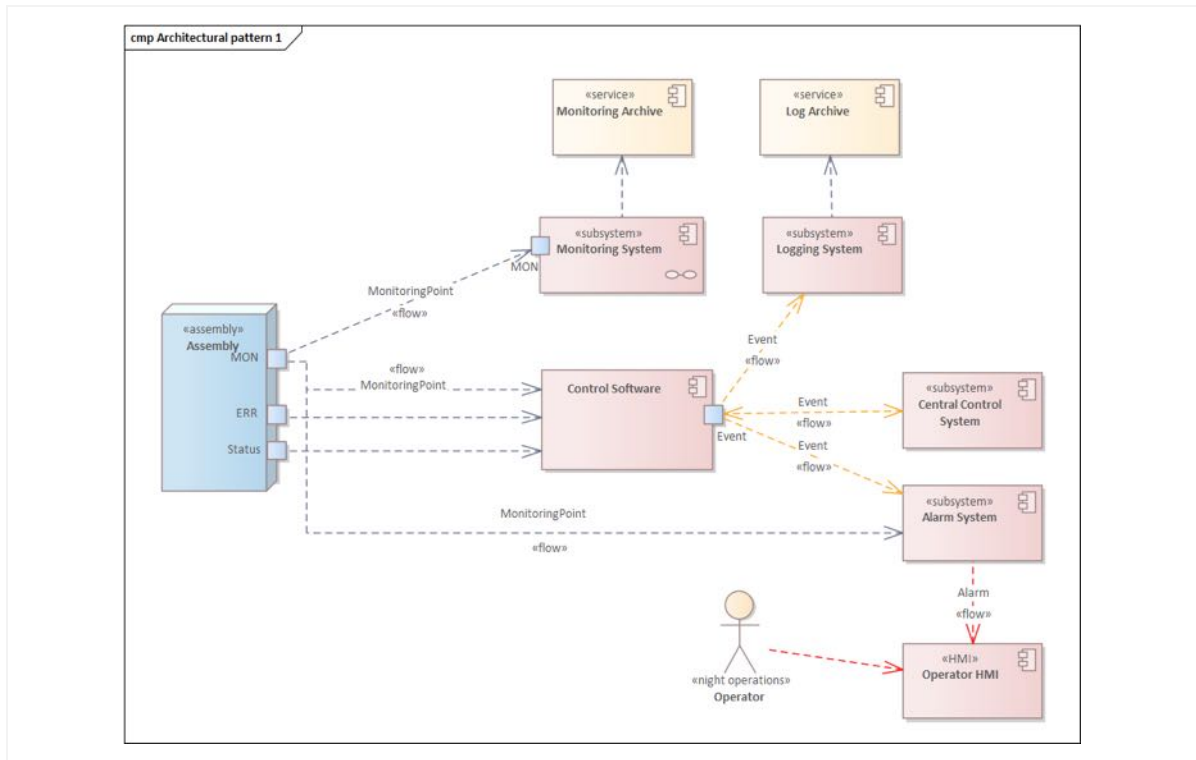

**Figure 32:** Pattern #1: identification of an assembly event with a control software/collector. The Figure shows only a Control Software, but a Connector can be present instead of the Control Software. If a Control Software/Collector is not present, this responsibility is given to the **Monitoring System**.

5.2.5.2. Communication pattern #2: identification of an assembly alarm with a control software or a collector

A general overview of the pattern #2 is given in Fig. 33. Main guidelines:

1. There is a SCADA **Control Software** or a **Collector** that receives alarms from an assembly. An alarm from assembly implies that an immediate action of the **Operator** is required.
2. The alarm generated by the assembly is notified to other SCADA subsystem by the Control Software/Collector as an event:
  - a. the event is sent to any subsystem that requires it using a publisher/subscriber mechanism. E.g. the **Central Control System** could receive the event;
  - b. the **Logging System** saves the event in the **Log Archive**.
3. The **Alarm System** receives directly the alarm generated by the assembly and forward the alarm to the **Operator**.
4. The **Central Control System** could generate a new event at a higher level that follows the pattern #1.

The systems that have a Control System are:

- **Telescope Control System;**
- **Atmosphere Characterisation System;**
- **Array calibration system.**

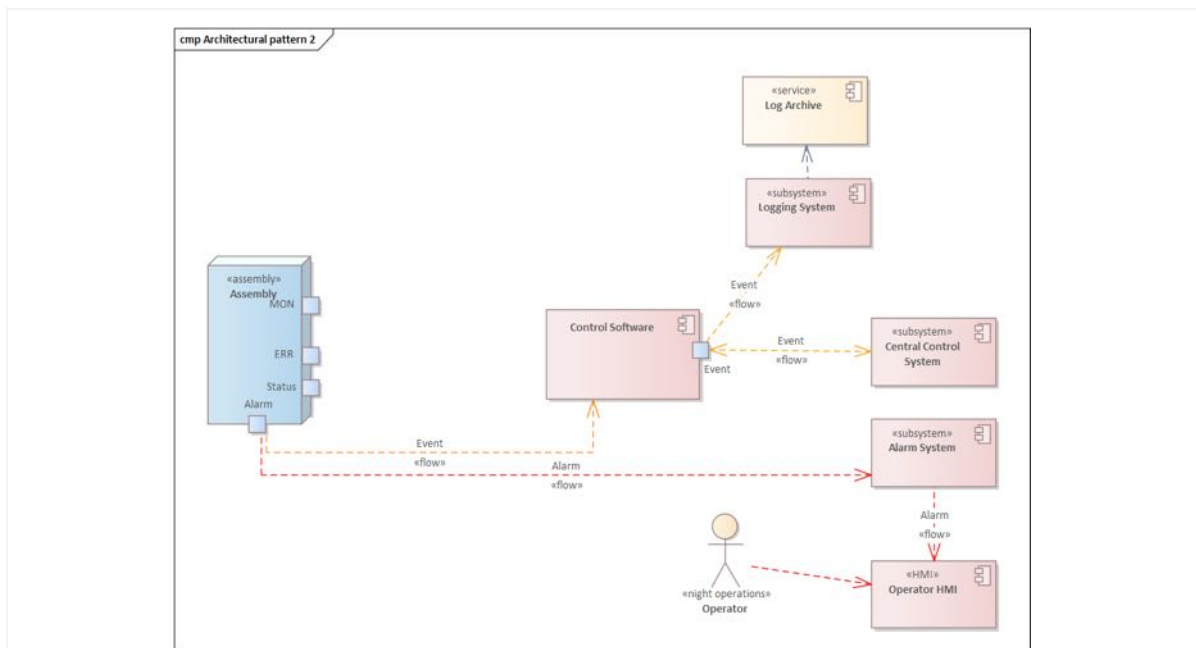

**Figure 33:** Pattern #2: detection of an assembly alarm with a Control Software or a Collector. The Figure shows only a Control Software, but a Connector can be present instead of the Control Software.

The systems that have Collectors and fulfill this communication pattern are:

- **Environmental Monitoring System;**
- Infrastructure:
  - **Power Management System;**
- Information Communication Technology:
  - **On-site ICT System;**
- Protection Subsystems:
  - **Safety and Security System.**

### 5.2.5.3. Communication pattern #3: reading of error codes

Some assemblies have error codes that can be read by only one Control Software. In this case it is mandatory that only one Control Software shall read the error code. A general overview of the pattern #3 is given in Fig. 34.

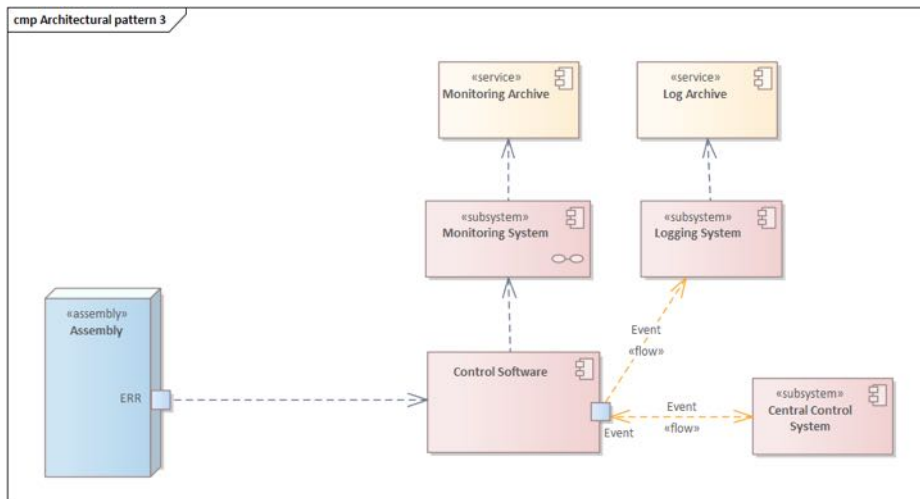

**Figure 34:** Pattern #3: reading of error codes

### 5.2.6. SCADA System Logical View

Fig. 35 describes the interconnection between the main functional blocks of SCADA, assemblies and subsystems. The **Central Control System** plays the central role in on-site operations. The **Central Control System** starts, shutdown and configures the on-site MA subsystems and related assemblies, and checks the status of the assemblies. A **System Configuration Database (SCDB)** (not shown in Fig. 35) is needed to configure the hardware and software subsystems/assemblies/devices to perform science, array calibration and technical operations.

The **Central Control System** shall get the Scheduling Blocks to perform observations selected by the **Operator** or retrieved in an automated mode, and shall execute and submit them for observations, interpreting the Observing Mode of the Observing Blocks to forward the configurations and commands downstream to the telescopes and other devices, manage the status of the observation (started, wait, etc). This is done by sending commands to the **Telescope Control System** that has direct control of the **Telescope Local Control Systems** dedicated to the real-time control of the hardware devices. All the relevant information is sent to a **Data Capture** (part of the Central Control System) to build the **Science Data Model**. The **Science Data Model** is saved into the **Science Archive**.

The **Central Control System** coordinates Control Software and Collectors to reach the scientific objectives of the observation.

**Logging System, Monitoring System and Alarm Systems** monitor the overall performance of the systems through the acquisition of environmental, monitoring and logging points and alarms from instruments and generates status reports or notifications to the **Operator** via the **Operator HMI**. In particular, the **Alarm System** provides the service that gathers, filters, exposes and persists all the relevant alarms raised by both assemblies (such as telescopes and other devices) and SCADA processes (Monitoring, Logging, Online Observation Quality systems). The logging, monitoring and alarm data are saved in the **Monitoring Archive, Logging Archive, and Alarm Archive**. These archives are periodically transferred to the **MA Data Center**.

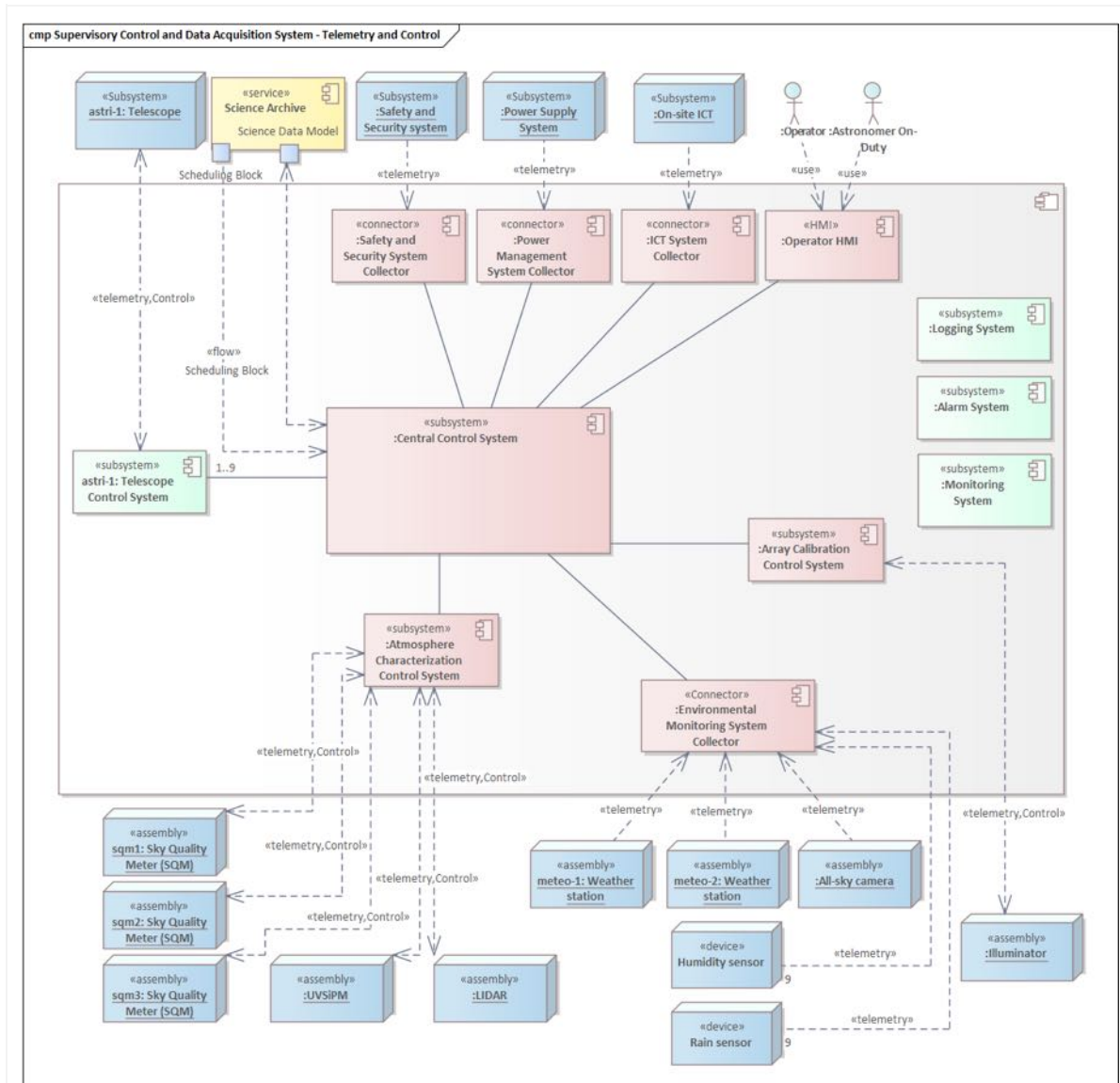

**Figure 35:** Telemetry and control flow. Logging system acquires logs from all events. Monitoring system acquires monitoring points from all assemblies. Alarm system receives alarms from assemblies. Only one telescope (and related subsystems) is shown. Not all connections are shown, in particular the interconnections between Control Software/Collectors and Central Control System are not shown. The SCDB is not shown.

Fig. 36 describes the data flow between assemblies and SCADA subsystems.

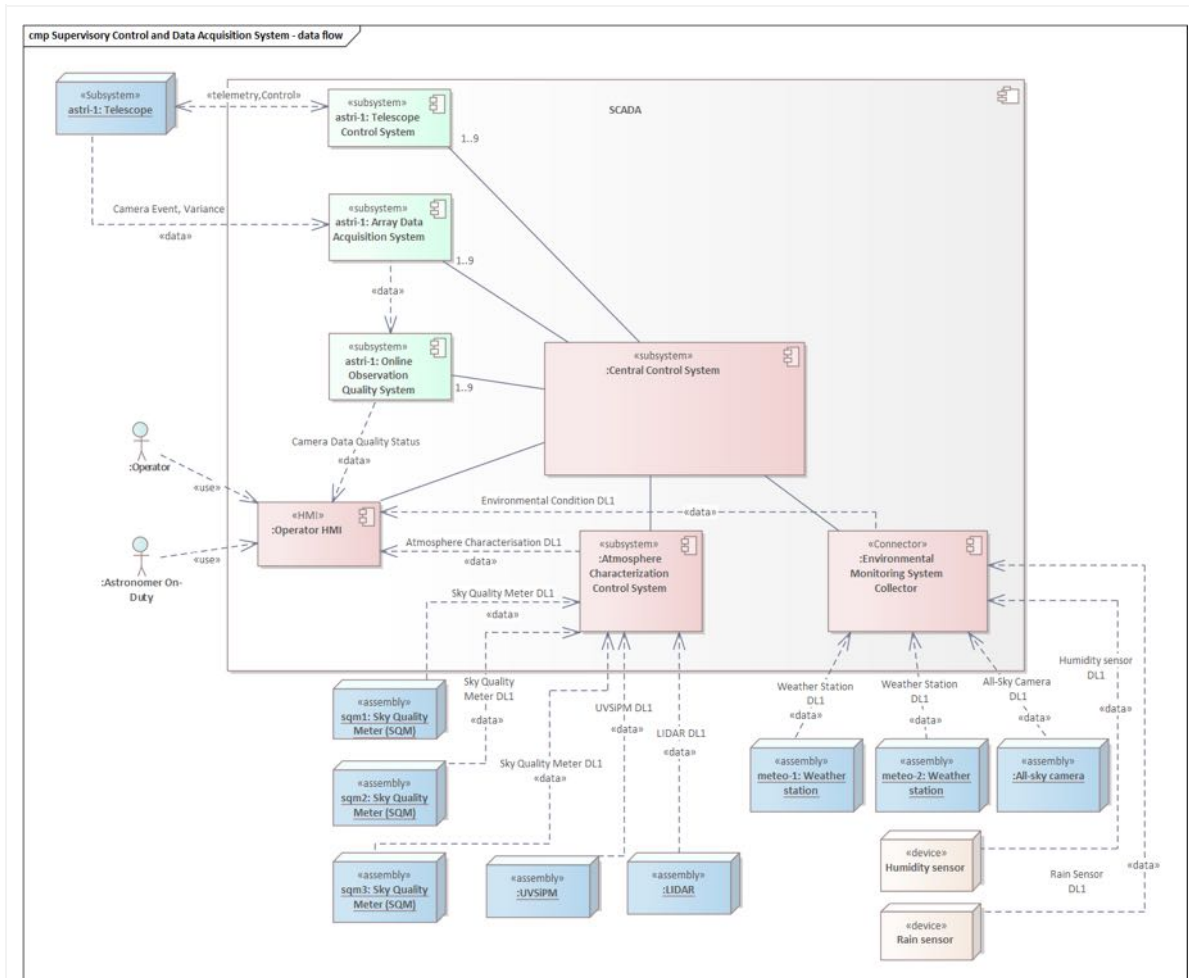



**Figure 36:** Data flow between assemblies and SCADA subsystems. Only one telescope (and related subsystems) is shown. Not all connections are shown, in particular the interconnections between Control Software/Collectors and Central Control System are not shown. The SCDB is not shown.

Cherenkov Cameras and SI<sup>3</sup> (periodically Observing Blocks for Intensity Interferometry data acquisition are performed) generate a set of raw data that are acquired by the **Array Data Acquisition System**, saved in the **Local Bulk Repository** and transferred to the **Bulk Archive** at the end of the Run. A subset of them is forwarded to the **Online Observation Quality System**.

The **Online Observation Quality** system focuses on ongoing problems (data quality checks) feeding the appropriate results to the **Operator**. The quality results are saved in the **Quality Archive** and periodically transferred to the **MA Data Center**.

The parts of the system that have real-time requirements are part of the Control, Data Acquisition, Alarm, Monitoring and Online Observation Quality systems. Direct streaming of raw data (from Cherenkov cameras, SI<sup>3</sup> and other assemblies), bypassing the archive, will be deployed for the Online Observation Quality system.

		<b>ASTRI Mini-Array</b> Astrofisica con Specchi a Tecnologia Replicante Italiana					
	<b>Code:</b> ASTRI-INAF-DES-2100-001	<b>Issue:</b>	2.5	<b>Date:</b>	Jun 18, 2021	<b>Page:</b>	72/119

### 5.2.7. Central Control System

[ASTRI-9.1.0.0-2050] The **Central Control System** coordinates the sequence of operations to perform observation, calibration and maintenance, coordinating the control systems and collectors, configure the on-site subsystems and assemblies, checks the status of the assemblies, get the Scheduling Blocks and interprets the Observing Mode specified to command downstream to the telescopes and other subsystems; a **Data Capture**, part of the Central Control saves the information associated with the execution of an Observing Block necessary to perform the scientific data processing of the acquired data needed by the **Data Processing System**.

[ASTRI-9.1.0.0-2052] The **Central Control System** coordinates and gets information from:

- the **Atmosphere Characterisation Control System**;
- the **Array Calibration Control System**;
- for each available telescope (from one to nine):
  - one **Telescope Control System**;
  - one **Array Data Acquisition System**;
  - one **Online Observation Quality System**.
- **Monitoring System**;
- **Logging System**;
- **Environmental Monitoring System Collector**;
- **On-Site ICT System Collector**;
- **Power Management System Collector**;
- **Safety and Security System Collector**.

[ASTRI-9.1.0.0-2056] The **Central Control System** shall implement the following **MA System** operation modes reported in Fig. 37:

- **Science Operation mode:** the mode where the science operations are performed. With reference to [AD12], the following modes are foreseen
  - Normal observation mode: this is used to observe the targets as defined by the Science Operation Plan. Usually science observations require dark time, within nautical twilight, although it is also possible to operate also during moderate moonlight conditions. Calibration activities are included in the normal operation mode.
  - ToO Mode: the science operation plan will identify some astrophysical targets (either a specific object or a class of objects) that, giving raises to transient phenomena, will require a response from the night operator and a change in the night schedule. This means that no dedicated automatic software procedure to react to these transient phenomena is foreseen. Depending on the type of transient object the reaction time will vary from a few hours (1 hour) to 1 day.
  - Coordinated Mode: possible synergies with the current VHE arrays (HAWC, MAGIC, LST, CTA...) in the northern hemisphere are foreseen in the science operation plan [AD3]. This means that simultaneous observations with some of these arrays, specifically MAGIC and LST, will be possible. Usually, those observations will be scheduled well in advance. Other synergies with optical telescopes already implemented at the Canary Islands (e.g. TNG) are also possible.
- **Technical Operation mode during the night:** a mode where monitoring is possible but science operations are not possible.

- **Technical Operation mode during the day:** a mode where monitoring, maintenance and engineering operations are possible. This includes the *maintenance mode* and the *Maintenance/Technical Operations* reported in [AD12].
- **Daily nominal operations:** a mode in which nominal monitoring and planning of the night activities are foreseen.

In particular the following main states shall be managed:

- nominal: all assemblies works in nominal mode;
- abnormal degraded: some subsystems work in degraded mode (i.e. with reduced performances) but the operations are still possible;
- abnormal fault: one or more subsystems are in fault mode;
- safe: all MA systems, including telescopes, are put in a safe state.

A **test operation mode** is foreseen, and some SCADA subsystems and components shall be operational but without communication with the array assemblies. This mode is used to test the behaviour of the SCADA subsystem in a representative environment.

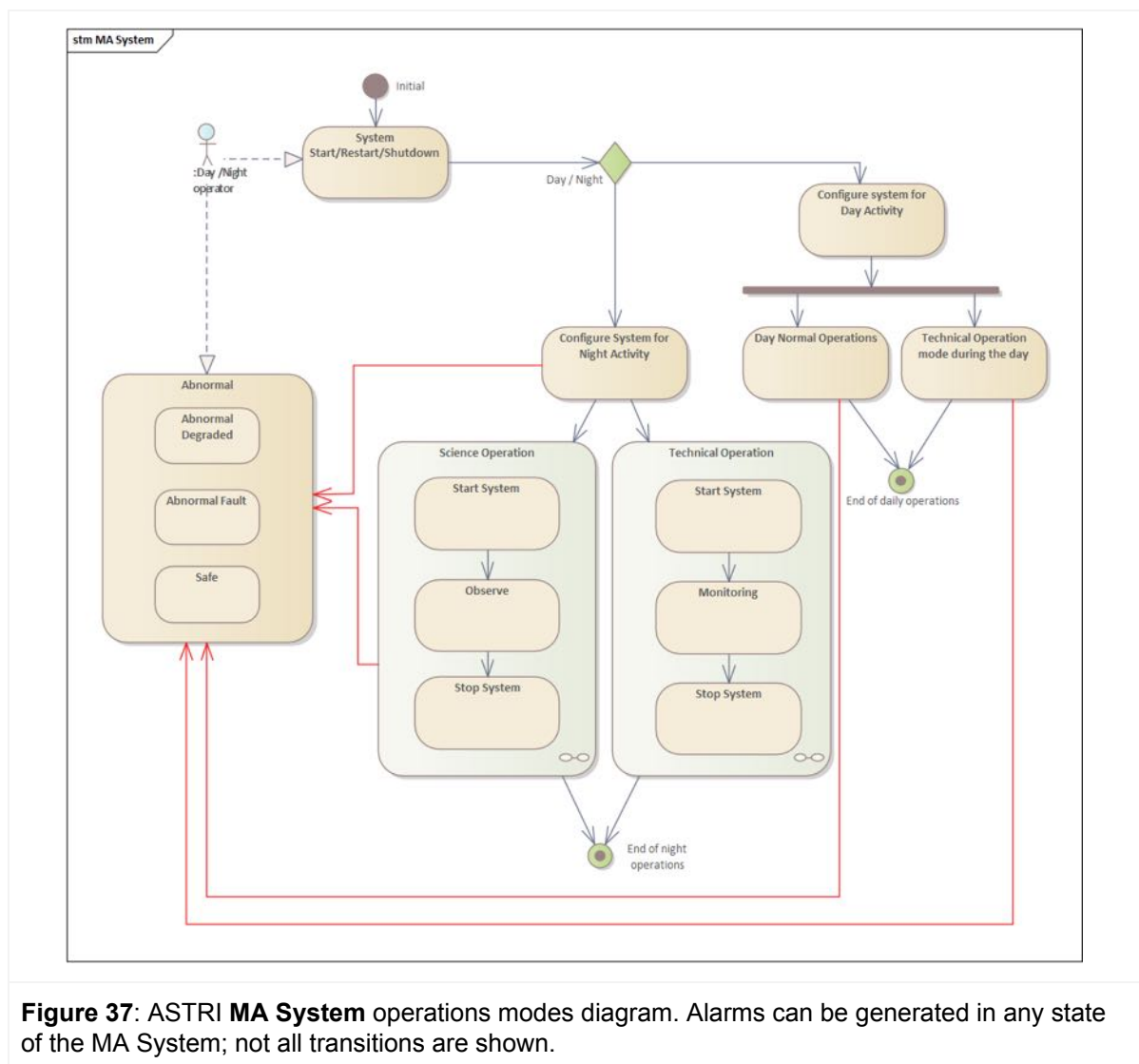

**Figure 37:** ASTRI MA System operations modes diagram. Alarms can be generated in any state of the MA System; not all transitions are shown.



[ASTRI-9.1.0.0-2057] The **Central Control System** shall manage the subsystem/system state machine of all subsystems of the ASTRI Mini-Array. The general state machine of the system shall be a composition of the subsystem state machines.

[ASTRI-9.1.0.0-2058] The **Central Control System** shall implement the observing modes Wobble and ON/OFF for Cherenkov data acquisition.

[ASTRI-9.1.0.0-2060] The **Central Control System** shall implement the observing mode for Stellar Intensity Interferometry.

[ASTRI-9.1.0.0-2061] The **Central Control System** shall start up all SCADA subsystems.

[ASTRI-9.1.0.0-2162] The **Central Control System** shall not be restarted for every configuration change of the controlled devices, so the system must be dynamically configurable.

[ASTRI-9.1.0.0-2064] The **Central Control System** shall get the overall array configuration from the **SCDB** and the observing plan from the **Science Archive** (as a list of Scheduling Blocks) in a manual or automated mode.

[ASTRI-9.1.0.0-2066] The **Central Control System** shall be able to automatically execute the whole sequence of operations needed to perform a scientific observation, from telescope movement to command the data acquisition and monitoring of all assemblies involved in the operations.

[ASTRI-9.1.0.0-2068] The **Central Control System** shall support the telescope and array calibration activities.

[ASTRI-9.1.0.0-2070] The **Central Control System** shall enable the **Operator** to supervise and carry out scheduled observations and calibrations during the night with an **Operator HMI**.

[ASTRI-9.1.0.0-2072] The **Central Control System** shall allow the **Operator** and the **Astronomer on-duty** to interact remotely with the MA System. The MA shall be operated from the Array Operation Centers (AOCs) available from different locations, including one at the Array Observing Site.



[ASTRI-9.1.0.0-2074] The **Central Control System** shall be controlled via the **Operator HMI**.

[ASTRI-9.1.0.0-2076] The **Central Control System** shall allow scientific observation in *normal* or *observation* environmental conditions [AD7].

[ASTRI-9.1.0.0-2078] The **Central Control System** shall forbid scientific observation and put the entire array in safe state in an automated way if there are *transition* or *survival* environmental conditions [AD7].

[ASTRI-9.1.0.0-2080] The **Central Control System** shall allow only one AOC to control the array, while any others shall be restricted to a read-only mode, suitable for monitoring.

[ASTRI-9.1.0.0-2082] The **Central Control System** shall retrieve the list of Observing Blocks of a Scheduling Block and shall perform a verification of the Observing Blocks. If the verification is not successful the Observing Block is discarded and the **Operator** is informed.

		<b>ASTRI Mini-Array</b> Astrofisica con Specchi a Tecnologia Replicante Italiana				
	<b>Code:</b> ASTRI-INAF-DES-2100-001	<b>Issue:</b> 2.5	<b>Date:</b> Jun 18, 2021	<b>Page:</b> 75/119		

**[ASTRI-9.1.0.0-2084]** The **Central Control System** shall manage the availability of telescopes and other assemblies or subsystems. A telescope that shall not be scheduled for operations shall be marked unavailable.

**[ASTRI-9.1.0.0-2086]** The **Central Control System** shall receive the Observing Blocks and shall interpret the Observing Mode specified by the Observing Block to forward the configurations and commands downstream to the telescopes and other assemblies and devices.

**[ASTRI-9.1.0.0-2088]** The **Central Control System** shall inform the **Operator** of the status of the execution of the Observing Blocks, to check the array conditions that may require stopping the currently executing Observing Blocks via the **Operator HMI**.

**[ASTRI-9.1.0.0-2090]** The **Central Control System** shall enable the **Operator** to suspend the execution of an Observing Blocks if there are no longer the environmental or atmosphere characterisation conditions to continue to acquire useful scientific data (e.g., for changes in atmosphere characterisation) using the **Operator HMI**.

**[ASTRI-9.1.0.0-2092]** The **Central Control System** shall create one **Telescope Control System** component, one **Array Data Acquisition System** component, and one **Online Observation Quality System** component for each telescope, to manage operations, the data acquisition and quality check.

**[ASTRI-9.1.0.0-2094]** A **Script Execution Engine** shall interpret scripts provided to the **Operator** and executed by the **Central Control**.

**[ASTRI-9.1.0.0-2096]** A **Data Capture** function, part of the **Central Control System**, shall save all the data necessary for the subsequent scientific analysis of the data (the Science Data Model). Data is collected by control systems or collectors. The Data Capture shall take the instrument-centric, time-ordered stream of data from different data models, collects, buffers, reorders and extracts those items needed in the science domain, and re-organizes the information to provide a summary of the current Run.

**[ASTRI-9.1.0.0-2098]** The Data Capture shall place links to the data acquired by the **Array Data Acquisition System** in the data structures that represent the Science Data Model.

See Fig. 38 for the data and control flow of the Data Capture and the relationship with other subsystems.

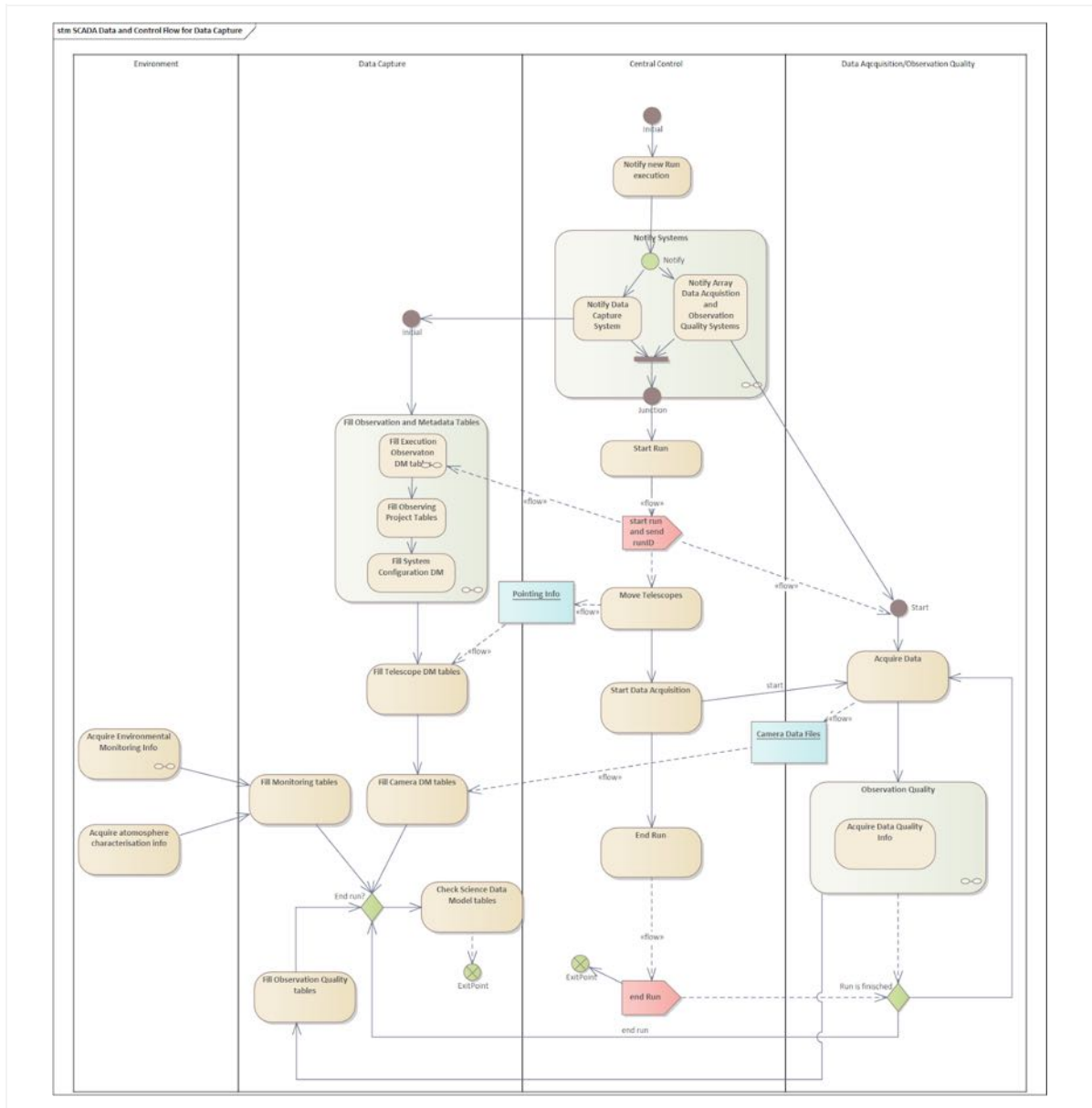



**Figure 38:** SCADA data flow and control flow for Data Capture, for the definition of the Science Data Model.

### 5.2.8. Array Data Acquisition System

A functional decomposition of the **Array Data Acquisition System** is shown in Fig. 39. This system works with the Cherenkov Camera Data Model and Stellar Intensity Interferometry Instrument Data Model (see [AD2]).

**[ASTRI-9.1.0.0-2100]** The **Array Data Acquisition System (ADAS)** shall acquire data from the Cherenkov camera and the SI<sup>3</sup>.

		<b>ASTRI Mini-Array</b> Astrofisica con Specchi a Tecnologia Replicante Italiana				
	Code: ASTRI-INAF-DES-2100-001	Issue:	2.5	Date:	Jun 18, 2021	Page: 77/119

[ASTRI-9.1.0.0-2102] The **Cherenkov Camera Data Acquisition** shall acquire the R0 (raw) data, as a bit stream packet by packet from the camera BEE via TCP/IP and generates the DL0 files in telemetry format, one per each telescope and for each Run, which are saved in a **Local Bulk Repository**. The Cherenkov Camera Data Acquisition:

1. saves the data within the same run in a binary file;
2. checks the packet integrity through packet length and Cyclic Redundancy Check (CRC);

[ASTRI-9.1.0.0-2104] The **Cherenkov Camera Data Acquisition** shall stream R0 also to the **Online Observation Quality System**.

[ASTRI-9.1.0-2106] The **Local Bulk Repository** shall temporarily store on-site the data acquired by the Array Data Acquisition system.

[ASTRI-9.1.0.0-2108] The **SI<sup>3</sup> Data Acquisition** shall acquire the DL0 files (raw) data from the SI3 Back End Electronics via FTP for each telescope and for each Run. DL0 files have a max size of 150 GB and are acquired at a maximum rate of 4 Gbit/s. Data is then copied in a **Local Bulk Repository** at a lower data transfer rate (1 Gbit/s).

[ASTRI-9.1.0.0-2112] The **ADAS** shall transfer the **Local Bulk Repository** files to the **Bulk Archive** once the Run is completed.

[ASTRI-9.1.0.0-2114] The **ADAS** shall send reports about the status of the acquisition to the **Operator HMI** at the end of each Run.

[ASTRI-9.1.0.0-2116] The **ADAS** shall generate alarms to the **Alarm System** if there are problems during the data acquisition.

[ASTRI-9.1.0.0-2117] The **ADAS Manager** shall interface with the **Central Control System**.



#### 5.2.8.1. Cherenkov Camera Pre-processing

[ASTRI-9.1.0.0-2118] DL0 files produced by the **Cherenkov Camera Pre-processing** shall be in FITS format, and the files will be grouped by telescope and Run, data sub-type (EVT, CAL, HK, VAR). The Pre-processing shall:

1. perform the translation from binary data to alphanumeric data (FITS), ready for the **Stereo Event Builder** and for the **Data Processing System** (see Sect. [5.4.](#));
2. split the different CAM data sub-types (see [AD2]) contained into the R0 data level (EVT, CAL, HK, VAR) in different data streams and FITS files;
3. perform the time reconstruction common to the **Stereo Event Builder** and the **Data Processing System**.

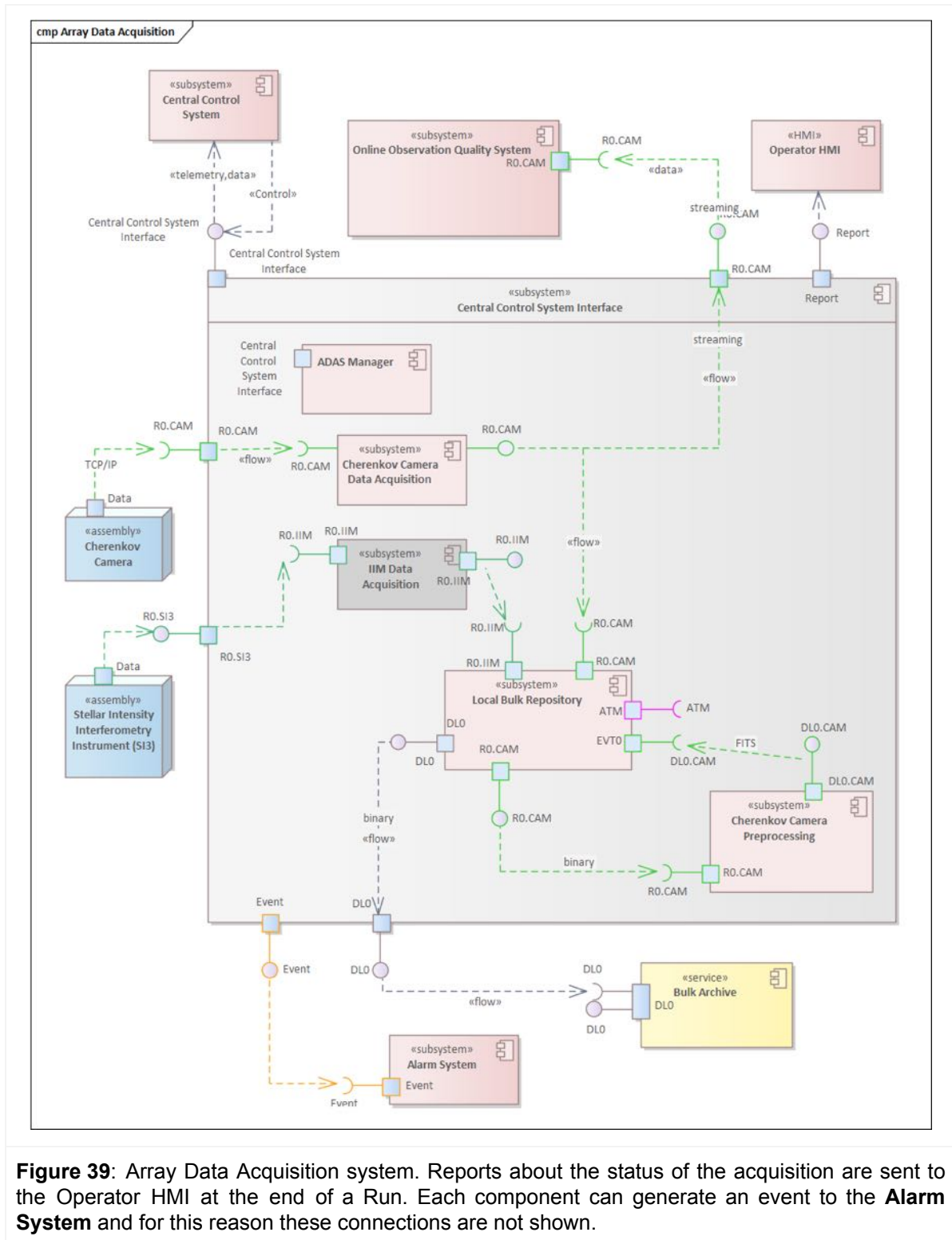
[ASTRI-9.1.0.0-2120] The **Cherenkov Camera Pre-processing** shall start from the **Local Bulk Repository** (on-site) or from the **Bulk Archive** (off-site, see Sect. [5.3](#)).



		<b>ASTRI Mini-Array</b> Astrofisica con Specchi a Tecnologia Replicante Italiana				
	Code: ASTRI-INAF-DES-2100-001	Issue:	2.5	Date:	Jun 18, 2021	Page: 79/119

### 5.2.9. Online Observation Quality System

A functional decomposition of the **Online Observation Quality System** is presented in Fig. 40. The Online Observation Quality System processes the data described by the Cherenkov Camera Data Model and the SI<sup>3</sup> Data Model (see [AD2]).

The ASTRI-UC-0-060 (see [AD3]) describes the functional workflow of <<data>> and <<control>> that involves the **Online Observation Quality System** and **SCADA** subsystems. The functional requirements reported in ASTRI-UC-0-060 are applicable to the Online Observation Quality System.

[ASTRI-9.1.0.0-2150] The **Online Observation Quality System (OOQS)** shall implement the following components: OOQS Manager, Cherenkov Camera Data Quality Checker, SI3 Data Quality Checker.

[ASTRI-9.1.0.0-2152] The **Online Observation Quality System (OOQS)** shall provide quick-look results of the Cherenkov and Intensity Interferometry observations during the data acquisition to give feedback to SCADA and the **Operator**.

[ASTRI-9.1.0.0-2154] The **Online Observation Quality System (OOQS)** shall provide an **OOQS Manager ACS** component for each telescope that is interfaced with the **Central Control System**. This OOQS Manager shall manage the internal component of the OOQS for each telescope.

[ASTRI-9.1.0.0-2156] The **Cherenkov Camera Data Quality Checker** shall perform a data quality check at telescope level of the following data products (of the Cherenkov Camera Data Model):

- DLO.CAM;
- DL1.CAM;

[ASTRI-9.1.0.0-2158]: The **SI3 Data Quality Checker** shall perform a data quality check at telescope level of the following data products (of the SI<sup>3</sup> Data Model):

- DLO.SI3;
- DL1.SI3, with an on-line calculation of the count rates on the four detector quadrants and a check of their balancing.

[ASTRI-9.1.0.0-2160] The **OOQS** shall generate reports at the end of each run with results obtained during the data quality analysis.

[ASTRI-9.1.0.0-2162] The **OOQS** shall provide data quality results to the **Operator HMI** to generate plots during the run.

[ASTRI-9.1.0.0-2164] The **OOQS** shall save the reports and the data quality check results in the **Quality Archive**.



[ASTRI-9.1.0.0-2166] The **OOQS** shall generate and send events to the **Central Control System** and/or to the **Alarm system** if there are problems during the data acquisition. Some conditions shall include problems in the software modules.

[ASTRI-9.1.0.0-2168] The **OOQS** shall send Data Quality analysis results to other subsystems that have to take decisions (e.g. the trigger rate of a PDM to the X system that shall decide if shutdown the PDM or not).

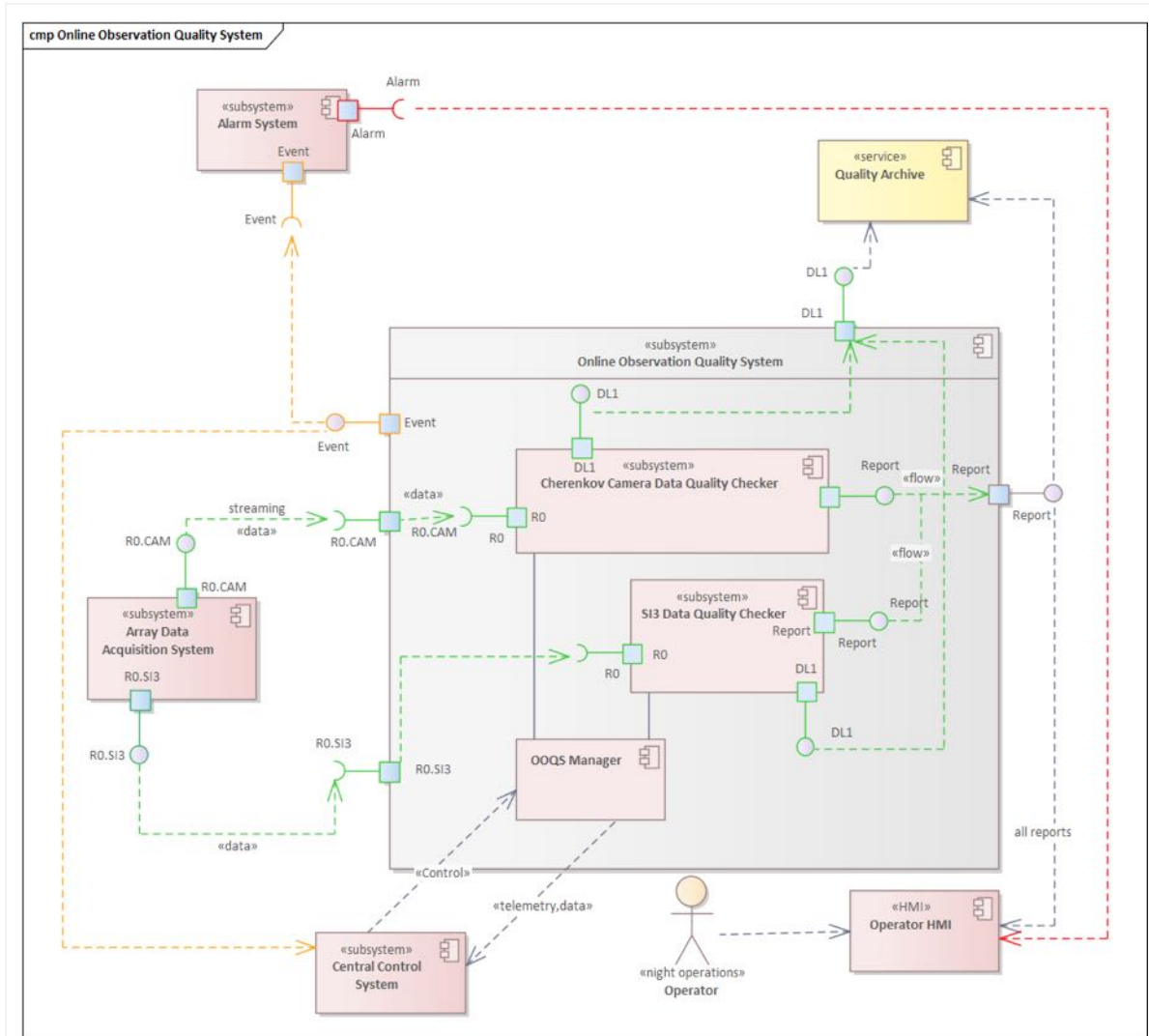
[ASTRI-9.1.0.0-2169] The **OOQS Manager** shall interface with the **Central Control System**.



**Figure 40:** On-line Observation Quality functional diagram. Each component can generate an event to the **Alarm System** and to the **Central Control System** and for this reason these connections are not shown.

		<b>ASTRI Mini-Array</b> Astrofisica con Specchi a Tecnologia Replicante Italiana					
	Code: ASTRI-INAF-DES-2100-001	Issue:	2.5	Date:	Jun 18, 2021	Page:	81/119

### 5.2.10. Logging System

The MA System can generate a huge amount of log files which, if uncontrolled, can cripple operations on a daily basis. Logging must be done therefore with attention to its impact on the system as a whole; logs inserted to debug particular problems should be disabled once the problem has been resolved. The framework foreseen for the SCADA software has many features for throttling log output as needed. As the MA Software System is likely to evolve continually, logs will be not only useful to diagnose failures detected during operation, but will also be needed for long term performance analysis and a quick view of the overall system behavior.

The **Logging System (LOG)** gets logging information from relevant software and hardware components that generate logs and stores it. This logging ingests: (i) software logs provided by subsystems using the control framework, (ii) software logs of the observation scripts and (iii) software logs produced by low level firmware, that requires reformatting to adapt to the rest of the logs, (iv) hardware systems, (v) logs to record the actions of the user over the HMIs in order to keep track of the activities that the operators perform on the system.

The Logging System defines the Logging Data Model (see [AD2])

Breakdown of the Logging System (see Fig. 41):

- The **Log Collector** is responsible for reading and collecting log records from the system's components and User Interfaces. It processes them, generating a log entry according to the log data model and sending them to the Queue. The list of component's endpoints to read from is stored in the **System Configuration Database (SCDB)**
- **Queue**: it's a very fast in memory database discarding data after a given retention period. It acts as a buffer to synchronize the other components of the subsystem that could operate at different speeds
- **Log Consumer**: it sends log entries to the Log Archive and communicates with the **Operator HMI** to provide them real time logging information.
- The **Logging Manager** acts as a coordinator: its task is to start and stop the entire subsystem and it provides the current status of logging subsystem components

**[ASTRI-9.1.0.0-2200]** The **Logging System (LOG)** shall allow the collection of the following log entries: software logs provided by subsystems using the control framework; software logs of the observation scripts; any aggregate log produced by SW low-level subsystems; logs of the ACS components; **Operator** logbooks; logs to record the actions of the user over the HMIs.

**[ASTRI-9.1.0.0-2202]** LOG shall be able to read configuration of the monitored devices and threshold criteria from the **SCDB**.

**[ASTRI-9.1.0.0-2204]** LOG shall save log events into the **Log Archive**.

**[ASTRI-9.1.0.0-2206]** LOG shall be able to provide a quick and versatile way to search and filter logs with a friendly graphical user interface.

**[ASTRI-9.1.0.0-2208]** LOG shall enable quick searches and filters over several months of logs.

**[ASTRI-9.1.0.0-2210]** LOG shall categorize log entries in terms of priority. This shall be performed using a Log Entry Level attribute



**[ASTRI-9.1.0.0-2212]** LOG shall categorize log entries in terms of relevance (Log Entry Level Definition)

**[ASTRI-9.1.0.0-2214]** LOG shall pass all logging information down to a configurable Log Entry Level to the LOG Archive for long term preservation and access for engineering purposes.

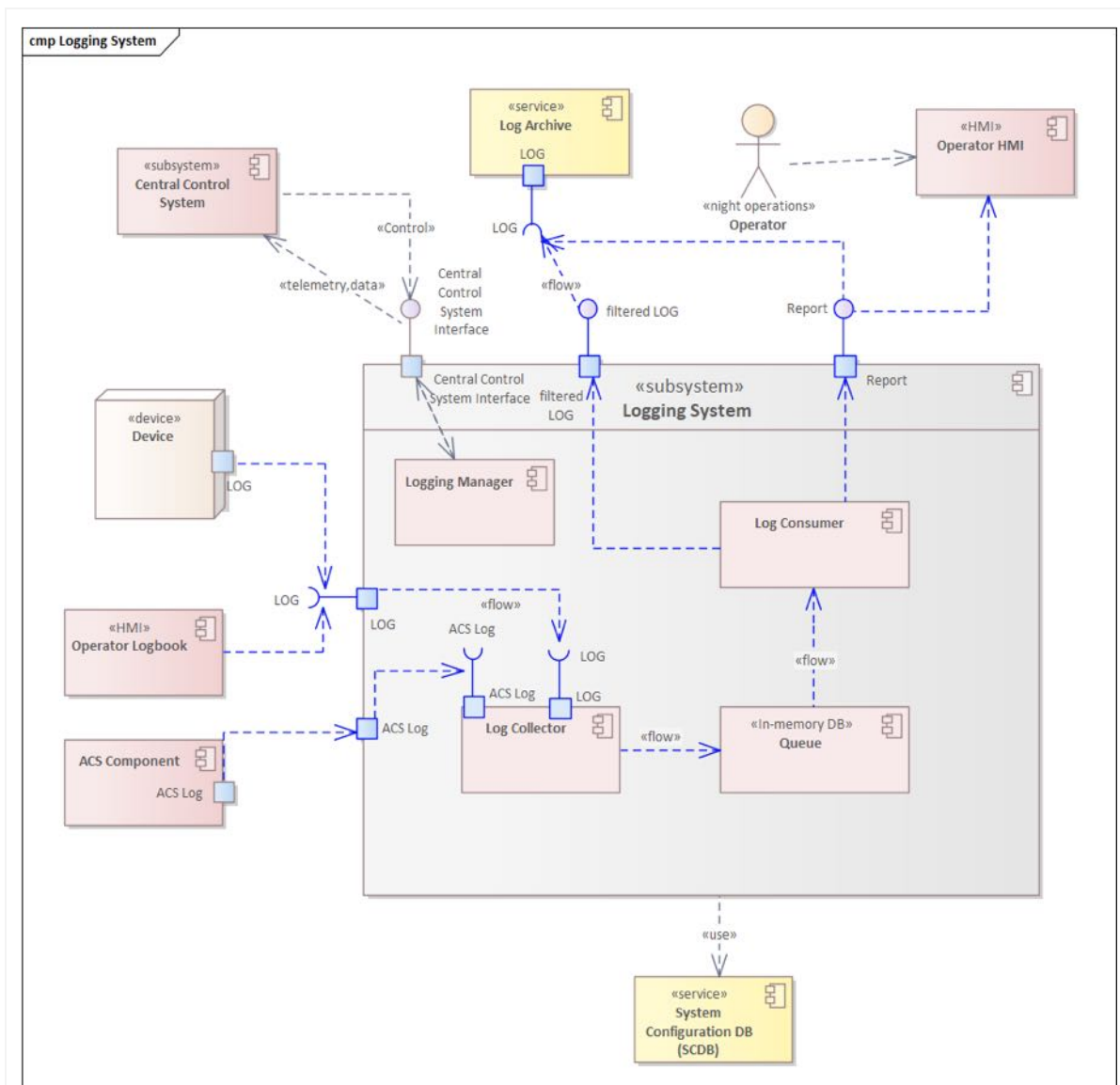
**[ASTRI-9.1.0.0-2215]** The **Logging Manager** shall interface with the **Central Control System**.



**Figure 41:** The Logging System. The Logging Manager coordinates the workflow.

		<b>ASTRI Mini-Array</b> Astrofisica con Specchi a Tecnologia Replicante Italiana					
	<b>Code:</b> ASTRI-INAF-DES-2100-001	<b>Issue:</b> 2.5	<b>Date:</b> Jun 18, 2021	<b>Page:</b> 83/119			

### 5.2.11. Monitoring System

The MA System will generate a massive set of monitoring data, collecting information on the performance of a variety of critical and complex electrical, electronic and mechanical components. This monitoring data is crucial for most troubleshooting efforts performed by engineering teams. The monitoring system should allow for the **Operator** a systematic approach to fault detection and diagnosis also toward supporting corrective and predictive maintenance to minimize the downtime of the system.

The **Monitoring System (MON)** provides the services that gather monitoring (about 20000 monitoring points as time series data at typically ~1 Hz rates) from all assemblies and devices of the ASTRI MA System, including the **Environmental Monitoring System** and saves them in the **Monitoring Archive**. It provides also a post facto framework for the evaluation and analysis of abnormal status or fault conditions. The **Monitoring System** works continuously to record any monitoring data. The **Monitoring System** provides a global base support service and is supposed to be up, running and available to any client that wants to use it at all times. The **Monitoring System** functionality can be broadly classified into three main areas: collection, persistence, and (limited) processing:

- **Collection.** Anything collected by the monitoring subsystem is associated with a time-stamp. Monitoring collects:
  - sensor data, and other similar data that changes over time,
  - status and other information.
- **Persistence.** Most monitoring data are persisted for later analysis and processing. The persisting may operate on the raw monitoring data, or on slightly processed material.
- **Processing.** The Monitoring System shall provide a means to run machine learning algorithms to detect anomalies and to search for patterns across collected monitoring alarm and logging data.

The **Monitoring System** defines the Monitoring Data Model (see [AD2]).

Breakdown of the Monitoring System (see Fig. 42):

- The **Data Collector** is responsible to retrieve monitoring points from both hardware devices (through the OPC-UA interface and protocols) and ACS Components. It is also in charge of data processing, filtering out duplicate values, and normalizing retrieved data in a common format (i.e. AVRO, JSON). It reads from the **System Configuration Database (SCDB)** the data sources (i.e OPC-UA and ACS endpoints) and the set of nodes to collect data from.
- The **Queue** takes formatted and validated monitoring points from the **Data Collector**. It's a very fast-in-memory database discarding data after a given retention period. It serves both as a buffer to synchronize data collectors and dispatchers that operate at different speeds and as a subscription/notification mechanism to any clients interested in receiving a streaming of real time monitoring data.
- The **Monitoring Point Dispatcher** consumes data from the **Queue**, delivering them to a long-term data storage, a **Monitoring Archive**, used to keep historical monitoring data, that will be able to resolve any queries coming from operators and engineering GUIs. The dispatcher can also generate event notifications for the **Alarm System**.
- **Monitoring GUI, part of the Operator HMI:** it represents a set of different User Interfaces, accessible from the web, desktop and mobile clients, through which interested users can

watch in real-time a streaming of monitoring data and can browse and query the historical one. It's made up of a backend exposing data through HTTP/GraphQL APIs and Websockets to multiple frontends.

- The **System Configuration Database (SCDB)**, see Sect. [5.2](#).
- The **Monitoring Manager** acts as a coordinator: its task is to start and stop the entire subsystem and it provides the current status of monitoring subsystem components.

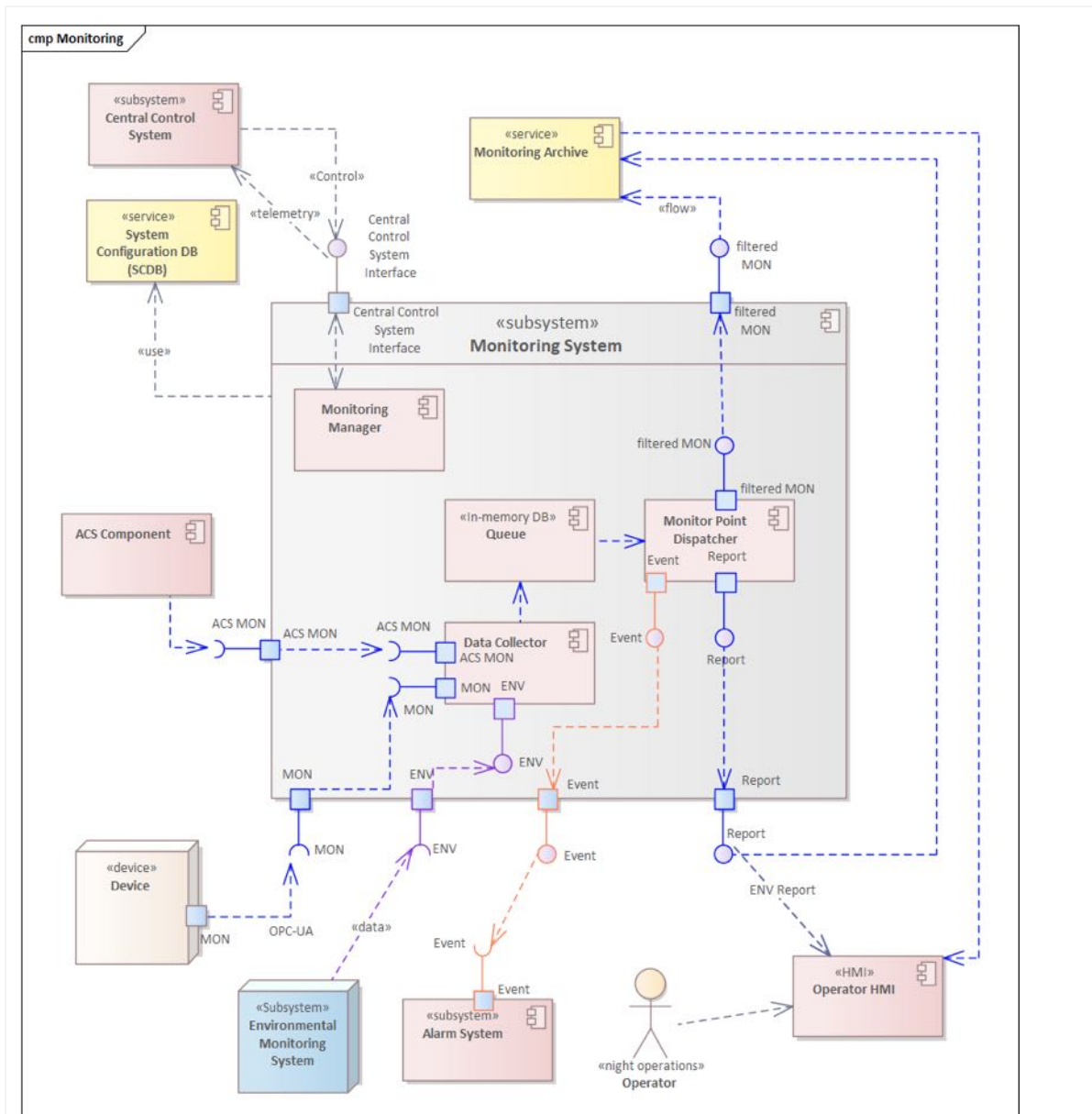

**Figure 42:** The Monitoring System. The Monitoring Manager coordinates the workflow.



[ASTRI-9.1.0.0-2250] The **Monitoring System (MON)** shall be able to get monitoring points from heterogeneous assemblies, devices and software systems, including ACS components.

[ASTRI-9.1.0.0-2252] **MON** shall be able to acquire, process and save environmental condition data from the **Environmental Monitoring System**.

[ASTRI-9.1.0.0-2254] **MON** shall save monitoring points into the **Monitoring Archive**.

[ASTRI-9.1.0.0-2256] **MON** has a limited processing capabilities:

- suppression of duplicate values, e.g., if there is no need to keep repeating with full frequency a sensor's value or a component's state, as long as that value or state does not change;
- comparison functions, so that processing emits a value only if an incoming value has been within a predefined window of values;
- provide certain statistical processing;
- filtering sensor values depending on some status.

[ASTRI-9.1.0.0-2258] **MON** shall be able to read configuration of the monitored devices and threshold criteria from the **SCDB**.

[ASTRI-9.1.0.0-2260] **MON** shall be able to elaborate each type of input independently of its format and the software system providing it.

[ASTRI-9.1.0.0-2262] **MON** shall gather together the data streams from the monitoring points and process them in streaming, saving processed results in a database optimised to offer high scalability and I/O performance.

[ASTRI-9.1.0.0-2264] **MON** shall allow the browsing of the monitoring data off-line to reconstruct past events or for further investigations.

[ASTRI-9.1.0.0-2266] **MON** shall provide the capability to resample the monitoring information coming in the form of irregular and unevenly-spaced time series data to a consistent and regular frequency.



[ASTRI-9.1.0.0-2268] **MON** shall allow **Operator HMI** to access the monitoring archive in order to:

1. Selection of monitor data to be analysed: devices, monitor points, time range.
2. Access to re-sampled data.

[ASTRI-9.1.0.0-2270] **MON** shall pass event notifications to the **Alarm System**.

[ASTRI-9.1.0.0-2272] **MON** shall be launched by the **Central Control System** or it should be launched manually.

[ASTRI-9.1.0.0-2273] The **Monitoring Manager** shall interface with the **Central Control System**.

		<b>ASTRI Mini-Array</b> Astrofisica con Specchi a Tecnologia Replicante Italiana					
	Code: ASTRI-INAF-DES-2100-001	Issue:	2.5	Date:	Jun 18, 2021	Page:	86/119

### 5.2.12. Alarm System

The MA system is composed of many hardware and software systems like the Array, the cooling system, the power and so on.

The **Alarm System (AS)** provides the service that gathers, filters, exposes and persists all the relevant alarms raised by both assemblies and devices (such as telescopes) and SCADA processes under the supervision of the SCADA system. It also creates and filters new alarms based on a selection of the most critical monitoring points. The alarms, which by definition require human attention and response, are sent to Operators via the HMI.

The **Alarm System** is a basic **Operator** support system for managing abnormal (also called non-nominal) situations and it has the following two functions:

1. To warn the **Operator** about a situation that is not normal; alarms must be relevant to the operator's role at the time, indicate what response is required, be presented at a rate the operator can deal with, and be easy to understand.
2. To serve as an alarm and event log, which can be used for an analysis of incidents and to optimise operations.

Breakdown of the main component of the Alarm System (see Fig. 43):

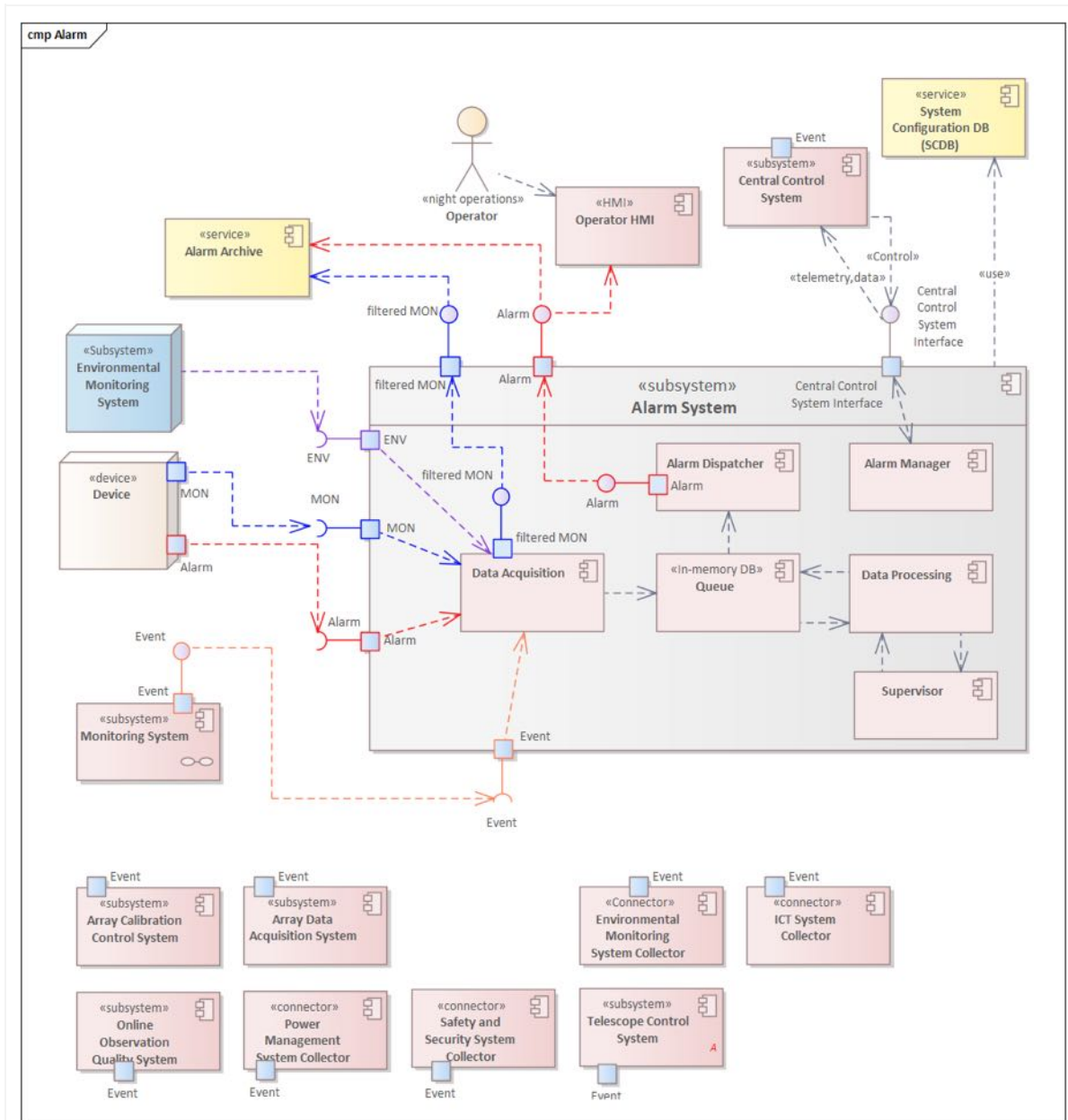

- **Data acquisition:** a software component that interfaces with remote control software via OPC-UA protocol to collect and send monitor point values to the Queue. It is also in charge of filtering out and discarding duplicate values. It reads from the System Configuration Database (SCDB) the data sources (i.e OPC-UA and ACS endpoints) and the set of nodes to collect data from.
- **Data processing:** it takes data points from the Queue and normalizes them in a common data structure, as defined in the data model. Then it sends them back to the Queue.
- **Supervisor:** it's the core of the subsystem. Its task is to evaluate the inputs provided by the remote systems through the queue against the model and defined rules (found in the **Configuration Database**), and ultimately generate a number of alarms, either set or cleared. It writes back alarm points to the Queue.
- **Queue:** it's a very fast-in-memory database discarding data after a given retention period. It serves both as a temporary storage of raw and unformatted monitoring points and actual alarm data points, generated by the supervisor. It also acts as a buffer to synchronize the other consumer components of the subsystem that could operate at different speeds
- **Alarm dispatcher:** it notifies and sends alarm data points both to the long term alarm archive and to the operator GUIs, using HTTPs APIs and/or Websocket protocols.
- **Alarm Manager:** acts as a coordinator: its task is to start and stop the entire subsystem and it provides the current status of alarm subsystem components.



**Figure 43:** Alarm System. The Alarm Manager coordinates the workflow. All control systems or collectors shown in the figure can generate critical event notifications

**[ASTRI-9.1.0.0-2300]** The **Alarm System (AS)** shall collect alarms from all assemblies/devices of the MA Systems.

**[ASTRI-9.1.0.0-2302]** **AS** must be able to get alarm events from heterogeneous hardware and devices, process them to generate alarms.

		<b>ASTRI Mini-Array</b> Astrofisica con Specchi a Tecnologia Replicante Italiana					
	<b>Code:</b> ASTRI-INAF-DES-2100-001	<b>Issue:</b>	2.5	<b>Date:</b>	Jun 18, 2021	<b>Page:</b>	88/119

**[ASTRI-9.1.0.0-2304] AS** must be able to get warning or critical event notifications from software components and process them to generate alarms.

The AS shall collect event notifications from SCADA control systems and collectors and generate alarms.

**[ASTRI-9.1.0.0-2306] AS** shall check the environmental conditions acquiring data from **Environmental Monitoring System** devices to determine if the environmental conditions are *normal*, *observation*, *transition*, *survival* (ASTRI-UC-0-030 [AD3]). If the conditions are transition or survival the **AS** shall generate alarms.

**[ASTRI-9.1.0.0-2308] AS** has a limited processing capabilities:

- suppression of duplicate values, e.g., if there is no need to keep repeating with full frequency a sensor's value or a component's state, as long as that value or state does not change;
- comparison functions, so that processing emits a value only if an incoming value has been within a predefined window of values;
- provide certain statistical processing;
- filtering sensor values depending on some status.

**[ASTRI-9.1.0.0-2310] AS** shall save alarm events into the **Alarm Archive**.

**[ASTRI-9.1.0.0-2312] AS** shall be able to read configuration of the monitoring points and alarms and threshold criteria from the **SCDB**.

**[ASTRI-9.1.0.0-2314]** The **Operator HMI** shall allow the **Operator** to acknowledge each alarm. Acknowledging the alarm means that the alarm notification itself will be cleared, but not that the abnormal status will be cleared at the same time. If a component reports an alarm because of an abnormal status and the status returns to normal, either through user action or by itself, the alarm notification will not be cleared automatically either. The actual action to resolve an alarm, or rather the underlying abnormal condition, is not part of the AS.

**[ASTRI-9.1.0.0-2316] AS** shall define 4 states for each alarm event:

1. New: the operator has not yet responded to the alarm
2. Acknowledged: the operator has acknowledged the alarm; this is required for severe alarms.
3. Shelved: The operator has removed the alarm from the display
4. Cleared: The operator has cleared the alarm.

**[ASTRI-9.1.0.0-2318] AS** shall log any state change related to the alarms with clear information regarding the timestamp of the action and the operator who performed the change.

**[ASTRI-9.1.0.0-2320] AS** shall categorize all alarms events generated internal to MA systems in terms of severity. The following alarms levels are defined:

1. Warning: Describe and report about conditions that are not alarms but that could lead to alarms.
2. Alarm: Denote an alarm condition
3. Severe: Denote a severe alarm condition.



[ASTRI-9.1.0.0-2322] **AS** shall be presented in a hierarchical way, with drill-in capabilities to the detailed individual alarms. This will allow the **Operator** to understand clearly the original source of the alarm.

[ASTRI-9.1.0.0-2324] **AS** shall manage the hierarchy of alarms. For components that represent an underlying hierarchy of subcomponents, the propagation rules shall be specified as part of the alarm system configuration. The default behaviour shall be that an aggregated component shows the most severe status of any of its subcomponents.

[ASTRI-9.1.0.0-2326] **AS** shall provide the **Operator** with the capability shelving (suppress/inhibit) all or individual alarms for a particular source for a user defined period, preventing subsequent alarms from being sent to the system. It shall be logged when alarms are manually shelved.



[ASTRI-9.1.0.0-2328] **AS** shall provide a means to dismiss and suppress repeating alarms. It shall be logged when alarms are manually shelved. Severe alarms cannot be suppressed.

[ASTRI-9.1.0.0-2330] **AS** shall be able to detect deviations of monitored quantities and raise appropriate Alarm Level to the **Operator HMI**.

[ASTRI-9.1.0.0-2332] The **AS** must present alarms with visual context information.

[ASTRI-9.1.0.0-2336] **AS** shall be launched by the **Central Control System** or it should be launched manually.

[ASTRI-9.1.0.0-2337] The **Alarm Manager** shall interface with the **Central Control System**.

		<b>ASTRI Mini-Array</b> Astrofisica con Specchi a Tecnologia Replicante Italiana					
	Code: ASTRI-INAF-DES-2100-001	Issue:	2.5	Date:	Jun 18, 2021	Page:	90/119

### 5.2.13. Operator Human Machine Interface

There shall be these types of HMI:

- **Local Engineering HMI**: the GUI of the Local Control Systems;
- **Startup System GUI**: the GUI of the Startup System;
- **Operator HMI**, the GUI of the SCADA system;
  - **Operator Logbook**: to save Operator log of the observations during the night. This is part of the **Operator HMI**
- **Engineering GUI** of the Control Systems and Collectors, e.g. TCS.

In the following requirements, the focus is on the **Operator HMI** provided by SCADA.

**[ASTRI-9.1.0.0-2350]** The **Operator HMI** shall remotely operate the **MA System**.

**[ASTRI-9.1.0.0-2352]** The **Operator HMI** shall provide an easily accessible, all-in-one-place near-real-time overview and monitor of the Mini-Array status that can be used for night and day operations.

**[ASTRI-9.1.0.0-2354]** The **Operator HMI** shall display results and reports from all SCADA subsystems so that progress of the observation and quality of the data acquisition can be monitored; and bringing alarm and warning conditions to the attention of the **Operator**. Numerous panels shall display monitoring, alarm and status information to help the **Operator** initiate corrective actions if necessary (e.g., in the case the **Operator** needs to explicitly request the start of a given service or any other software component or change the state of a running component).

**[ASTRI-9.1.0.0-2356]** The **Operator HMI** shall allow the **Operator** to control the MA System. It shall enable the **Operator** to initialize, start and stop the Observing System based on the configuration retrieved from the **SCDB**.

**[ASTRI-9.1.0.0-2358]** The **Operator HMI** shall be started up manually (locally on site or remotely) or by the **Startup System**.

**[ASTRI-9.1.0.0-2360]** The **Operator HMI** shall provide the **Operator** with tools to perform a full/partial MA system startup and shutdown.



**[ASTRI-9.1.0.0-2362]** The **Operator HMI** shall allow the **Operator** to select the Scheduling Blocks to be executed during the observation night.

**[ASTRI-9.1.0.0-2364]** The **Operator HMI** shall allow the **Operator** to follow and control the execution of the Scheduling Blocks (SB).

**[ASTRI-9.1.0.0-2366]** The **Operator HMI** is a web client that shall connect to the SCADA web server. The **Operator HMI** shall allow a secure web connection.

**[ASTRI-9.1.0.0-2368]** The **Operator HMI** shall run and show its main panels.

**[ASTRI-9.1.0.0-2370]** The **Operator HMI** shall allow the **Operator** to follow the status of the Cherenkov and SI3 data acquisition.

		<b>ASTRI Mini-Array</b> Astrofisica con Specchi a Tecnologia Replicante Italiana					
	<b>Code:</b> ASTRI-INAF-DES-2100-001	<b>Issue:</b>	2.5	<b>Date:</b>	Jun 18, 2021	<b>Page:</b>	91/119

**[ASTRI-9.1.0.0-2372]** The **Operator HMI** shall allow the **Operator** to have a first look at the quality of the Cherenkov and SI3 acquired data.

**[ASTRI-9.1.0.0-2374]** The **Operator HMI** shall allow the **Operator** to have a visual feedback of the sky field around the MA system pointing direction.

**[ASTRI-9.1.0.0-2376]** The **Operator HMI** shall allow the **Operator** to have a persistent and clear view of all the environmental condition and atmosphere characterisation parameters at the Array Observing Site.

**[ASTRI-9.1.0.0-2378]** The **Operator HMI** shall allow the **Operator** to have a persistent and clear view of all the telescope pointing parameters.

**[ASTRI-9.1.0.0-2380]** The **Operator HMI** shall allow the **Operator** to have a persistent and clear view of the status of the data transfer and archiving in the local bulk repository.

**[ASTRI-9.1.0.0-2382]** The **Operator HMI** shall allow the **Operator** to have a persistent and clear view of the status of the data transfer to the permanent offsite Data Center.

**[ASTRI-9.1.0.0-2384]** The **Operator HMI** shall provide an authorisation and authentication system to allow the identification of the person that is performing the role of the **Operator**.

**[ASTRI-9.1.0.0-2386]** Only one instance of the **Operator HMI** shall remotely control the MA system. Other instances of the **Operator HMI** can allow the remote monitoring of the MA system.

The development of the HMI must be done in collaboration with the final users.

#### 5.2.14. Telescope Control System

A functional decomposition of the **Telescope Control System** is shown in Fig. 44.

**[ASTRI-9.1.0.0-2400]** The **Telescope Control System (TCS)** shall be responsible for coordinating all telescope assemblies, starting up, configure and shutting down the assemblies of the Telescope, supervising optical system control, telescope mount control and instrument control (Cherenkov Camera, Optical Camera and SI<sup>3</sup>).

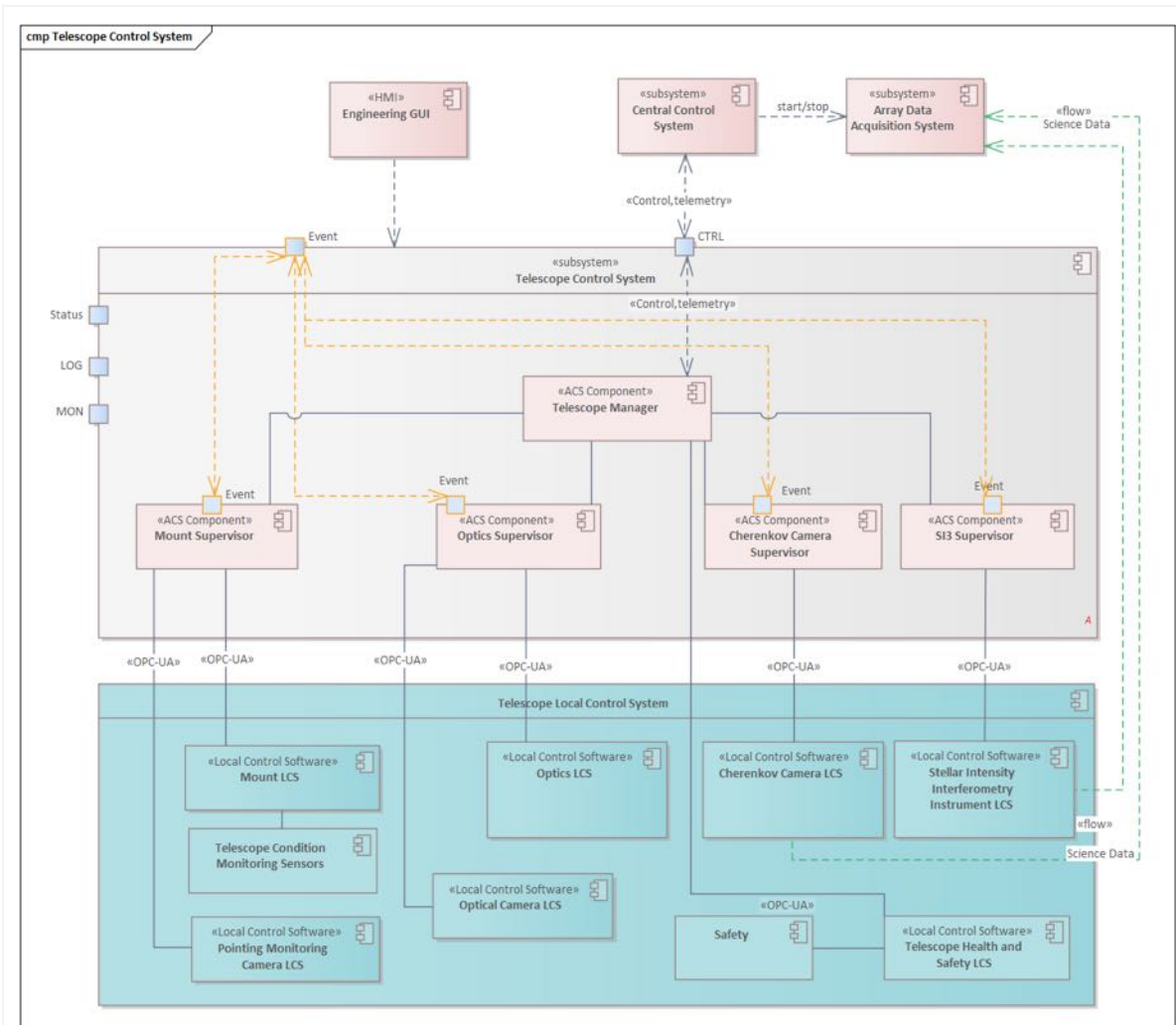



**Figure 44:** The Telescope Control System with supervisors and the Telescope Local Control System

**[ASTRI-9.1.0.0-2402]** The TCS shall work in two modes:

- manual mode: commands are received only using the Local Engineering HMI;
- automated mode: commands are received from the Central Control.

**[ASTRI-9.1.0.0-2404]** The main components of the TCS shall be:

- **Cherenkov Camera Supervisor:** the software component that controls and monitors the Camera LCS.
- **SI3 Supervisor:** the software component that provides an interface to the SI<sup>3</sup> LCS.
- **Mount Supervisor:** the software component that controls and monitors the mount LCS and other auxiliaries.
- **Optics Supervisor:** the software component that controls and monitors the Optics LCS and the Optical Camera LCS.
- **Telescope Manager:** the software component responsible for coordinating all TCS subsystems and starting up and shutting down the system.

		<b>ASTRI Mini-Array</b> Astrofisica con Specchi a Tecnologia Replicante Italiana					
	<b>Code:</b> ASTRI-INAF-DES-2100-001	<b>Issue:</b>	2.5	<b>Date:</b>	Jun 18, 2021	<b>Page:</b>	93/119

[ASTRI-9.1.0.0-2406] The **TCS** shall be able to generate alarms from the controlled and supervised assemblies and send the alarms to other SCADA subsystems.

[ASTRI-9.1.0.0-2408] The **TCS** shall provide an **Engineering GUI** to interact with all **TCS** subsystems that shall be accessed remotely for troubleshooting and maintenance.

[ASTRI-9.1.0.8-2410] The **Engineering GUI** shall be located at the site during the AIV phase.

[ASTRI-9.1.0.8-2412] If the **Engineering GUI** is enabled, the **Telescope Manager** cannot accept commands from the **Central Control System**.

[ASTRI-9.1.0.0-2413] The **Telescope Manager** shall interface with the Central Control System.

### 5.2.15. Environmental Monitoring System Collector

The ASTRI-UC-0-030 (see [AD3]) describes the functional workflow of <<data>>, <<telemetry>> and <<control>> that involves the **Environmental Monitoring System Collector** and **SCADA** subsystems. The functional requirements reported in ASTRI-UC-0-030 are applicable to the Environmental Monitoring System Collector.

[ASTRI-9.1.0.0-2450] The **Environmental Monitoring System Collector** shall acquire monitoring points, alarms, errors, status and logs from the **Environmental Monitoring System** assemblies to check the assemblies status and reliability.

Pattern #1 and pattern #3 (see [5.2.5.](#)) are applied.

[ASTRI-9.1.0.0-2452] The **Environmental Monitoring System Collector** shall acquire ENV data to identify *normal*, *observation*, *transition* and *survival* environmental conditions ([AD7]) and generate an Event to other SCADA subsystems in case of *transition* or *survival* environmental conditions.

[ASTRI-9.1.0.0-2454] The **Monitoring System** acquires all <<data>> and <<telemetry>> points of the **Environmental Monitoring System**, regardless of their use.

Fig. 45 shows the communication workflow for ENV data.

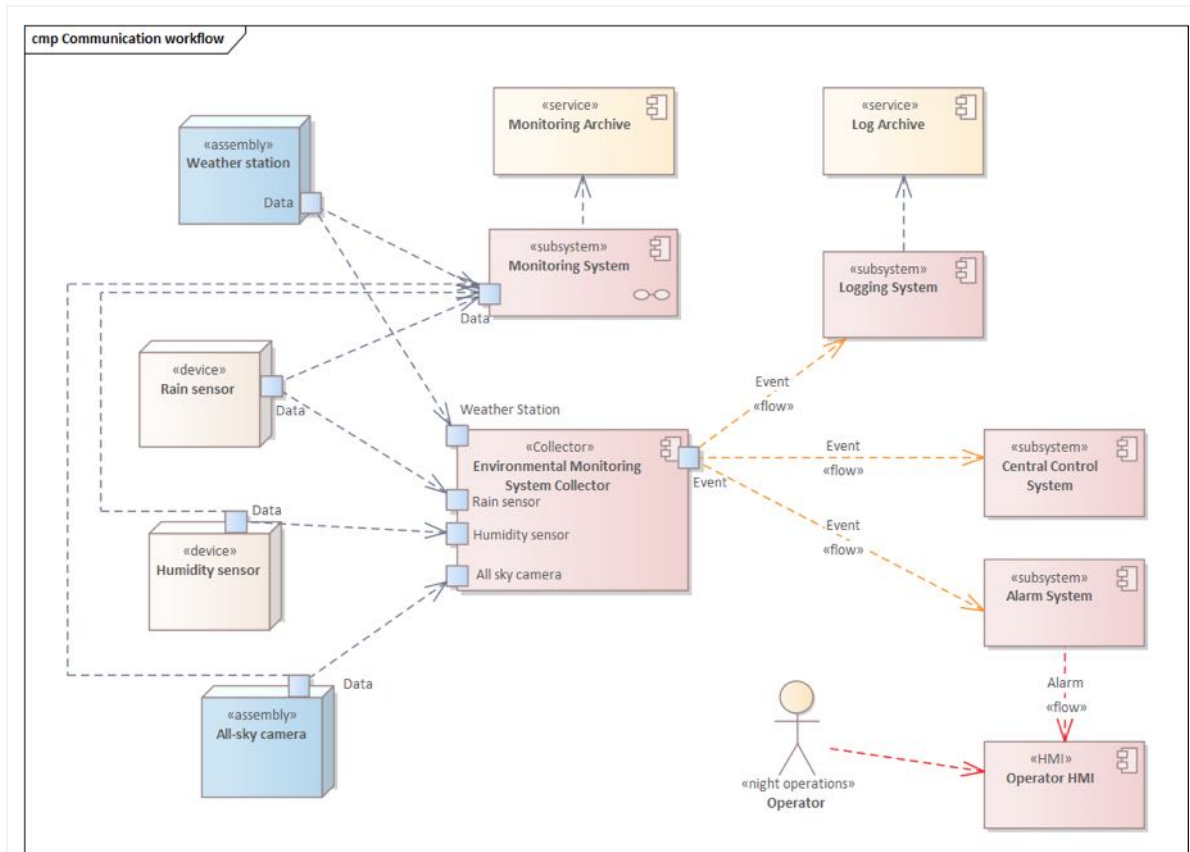

**Figure 45:** Environmental Monitoring System Collector. Connected assemblies/devices and communication workflow.

### 5.2.16. Atmosphere Characterisation Control System

The ASTRI-UC-0-035 (see [AD3]) describes the functional workflow of <<data>>, <<telemetry>> and <<control>> that involves the **Atmosphere Characterisation System** and **SCADA** subsystems. The functional requirements reported in ASTRI-UC-0-035 are applicable to the **Atmosphere Characterisation Control System**. The followed communication patterns are #1 and #2.

**[ASTRI-9.1.0.0-2500]** The **Atmosphere Characterisation Control System (ACCS)** shall manage the interfaces, control, monitor, get the status, generate assembly alarms, and acquire high-level (DL1.ATM) data of the **Atmosphere Characterization System**.

**[ASTRI-9.1.0.0-2502]** The **ACCS** components shall be:

- **LIDAR Supervisor:** the software component that controls, monitors, manage the state machine, assembly notification events, and acquire high-level (*Atmosphere Characterisation DL1*) data to the LIDAR LCS;
- **SQM Supervisor:** the software component that controls, monitors, manage the state machines, assembly notification events, and acquire high-level (*Atmosphere Characterisation DL1*) data to the three SQM LCSs;

- **UVSiPM Supervisor:** the software component that controls, monitors, manage the state machine, generate assembly notification events, and acquire high-level (*Atmosphere Characterisation DL1*) data to the UVSiPM LCS;
- **Atmo Manager:** the software component that manages the Atmosphere Characterisation System components and interfaces with the **Telescope Healthy and Safety LCS** to switch-on/switch-off the LIDAR, SQMs and UVSiPM;

The **ACCS** components are shown in Fig. 46.

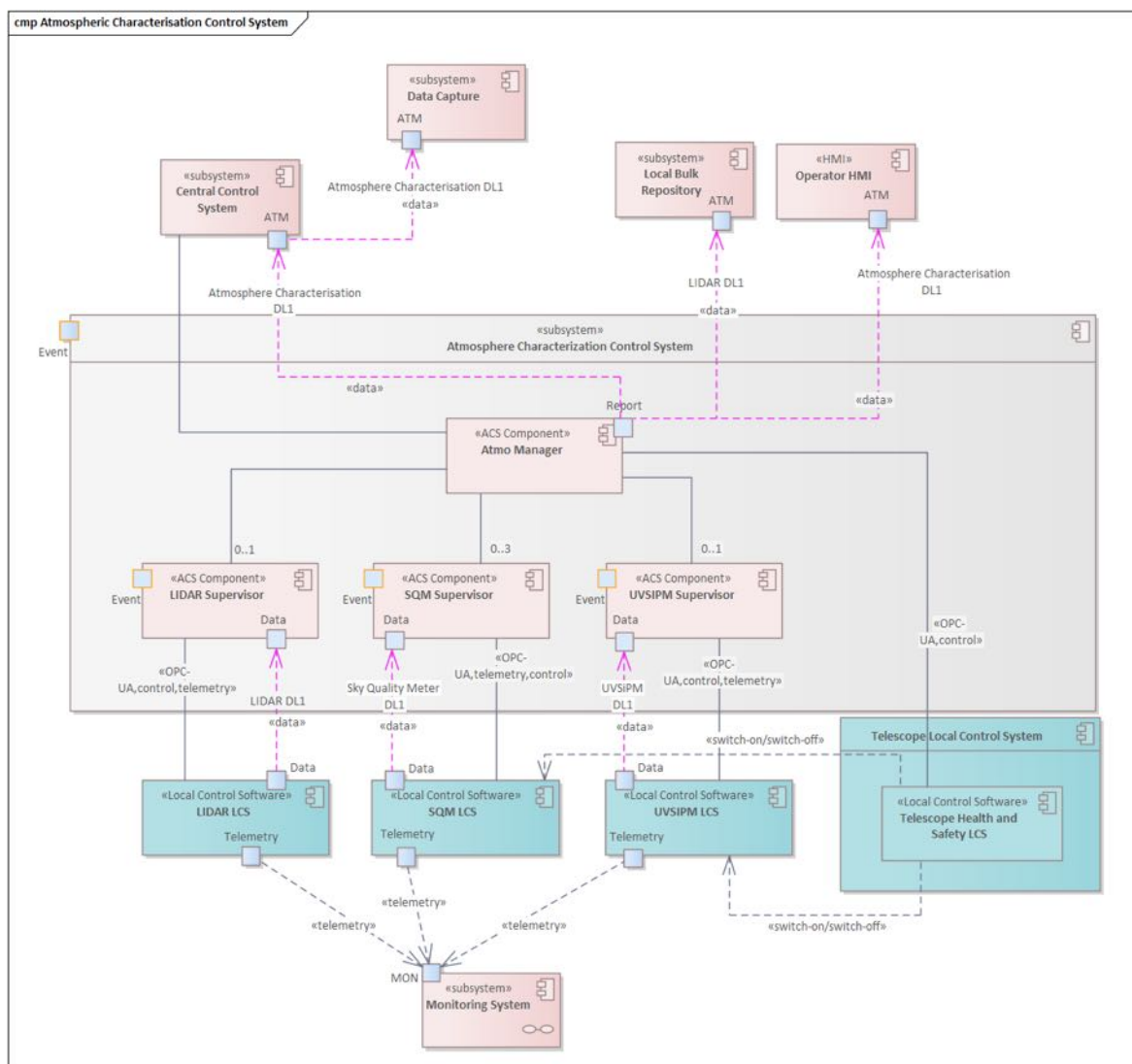

**Figure 46: Atmosphere Characterisation Control System.** The **Monitoring System** acquires all monitoring points. The raw DL0 data is saved on LCS and transferred to the Local Bulk Repository periodically. The followed communication patterns are #1 and #2. Events connections are not shown.

[ASTRI-9.1.0.0-2504] The **ACCS** send the *Atmosphere Characterisation DL1* data to the **Central Control System/Data Capture** and to the **Operator HMI**.

[ASTRI-9.1.0.0-2506] The followed communication patterns are the patterns #1 described in Sect. 5.2.5.1. and pattern #2 described in Sect. 5.2.5.2.

**Note:** The *Atmosphere Characterisation DLO* data is saved on LCS and transferred periodically off-site.

[ASTRI-9.1.0.0-2507] The **Atmo Manager** shall interface with the **Central Control System**.

### 5.2.17. Array Calibration Control System

[ASTRI-9.1.0.0-2550] The **Array Calibration Control System (ACALCS)** shall manage the interfaces with the **Array Calibration System**.



[ASTRI-9.1.0.0-2502] The **ACALCS** components shall be:

- **Illuminator Supervisor:** the software component that controls and monitors the LIDAR LCS
- **Array Calibration Manager:** the software component that manages the Array Calibration Control System components and interfaces with the **Central Control System**.

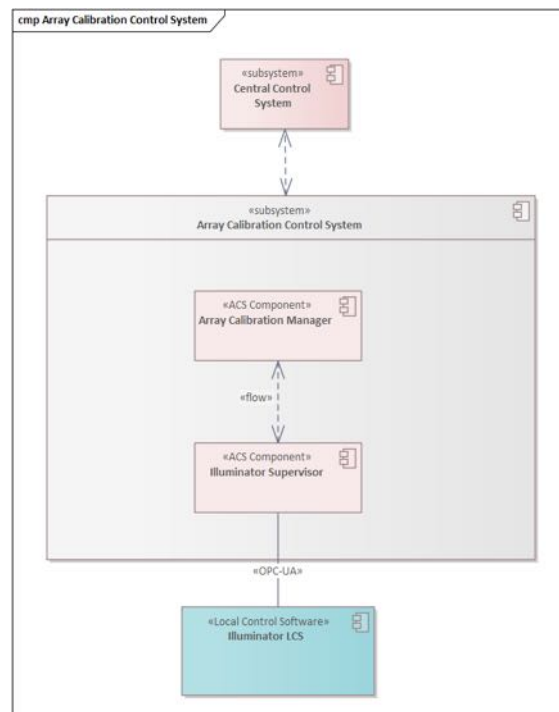
The main software components are reported in Fig. 47.



**Figure 47:** Array Calibration Control System

		<b>ASTRI Mini-Array</b> Astrofisica con Specchi a Tecnologia Replicante Italiana					
	Code: ASTRI-INAF-DES-2100-001	Issue:	2.5	Date:	Jun 18, 2021	Page:	97/119

### 5.3. Archive System

The **MA Archive System** plays a central role in the operation of the system, as already described in Sect. 3.8. The main purpose is storage and organization for all data, data products, and metadata generated for and by the MA, and defined by the MA Data Models (DM) [AD2].

**[ASTRI-9.2.0.0-2000]** The **ASTRI Archive System** is a software and hardware service that shall provide storage and organization for all data, data products, and metadata generated for and by the ASTRI MA, and defined by the ASTRI MA Data Models.

**[ASTRI-9.2.0.0-2010]** The complete **ASTRI MA Archive System** shall be composed by the following logical units:

- **Bulk Archive:** raw data from the Cherenkov camera, SI<sup>3</sup> and other assemblies, acquired by the **Array Data Acquisition System**. It stores the data products of the Cherenkov Camera DM and Intensity Interferometry DM.
- **Science Archive:** it stores the data products of the following data models:
  - Observing Projects DM and related observation plan, stored by the **Science Support System**.
  - Science DM and connected DMs, defined by the **Data Capture**.
  - Science Results DM (containing reduced high-level event-list, a.k.a. EVT3, reduced instrument response functions, a.k.a. IRF3, good-time data intervals (GTI), and automated science products (DL4)).
- **Simulation Archive:** it contains all the Monte Carlo events simulated by the **Simulation System** for the different MA configurations.
- **System Configuration Database (SCDB):** to store the System Configuration Data Model in [AD2], Sect. 13.
- **Monitoring Archive:** all the Monitoring Data Model subtypes (e.g. monitor assemblies, environmental data, see [AD2]) acquired by the **Monitoring System** are stored in this archive. These data, while lower in volume, may produce many records on subsecond time scales; on average, the Archive only needs to handle data sampled at 1 Hz or less, although faster sampling rates may be necessary for short time periods.
- **Alarm Archive:** the archive system that stores the alarms produced by all components and the monitoring data acquired by the **Alarm System** to generate alarms.
- **Quality Archive:** stores the cherenkov and intensity interferometry observation quality results produced by the **Online Observation Quality System**.
- **Log Archive:** the archive system that stores the logs produced by all components and acquired by the **Logging System**.
- **CALDB:** a dedicated calibration database, organized following HEASARC's CALDB format [RD4], that stores IRFs, LUTs, ML-MODELS, and other instrumental and pre-computed quantities available for being used throughout the entire scientific data reduction chain.

A further archive level, the **Science Legacy Archive**, might be created with MA high-level scientific and legacy data products compliant with Virtual Observatory (VO) standards. Such products could be compared with products from other observatories at other wavelengths using VO tools.

**[ASTRI-9.2.0.0-2020]** The **ASTRI MA Archive System** shall be formed by two separate units:

- A **Site Archive System** at Teide.
- An **Off-site Archive System** in the ASTRI MA Data Center in Rome.

**[ASTRI-9.2.0.0-2030]** The complete **ASTRI MA Archive System** shall be deployed at the off-site ASTRI Data Center in Rome.



**[ASTRI-9.2.0.0-2040]** The **Site Archive System** shall be a temporary system that shall produce all the on-site Monitoring, Logging, Alarm, Quality and Configuration DB services.

**[ASTRI-9.2.0.0-2050]** The **Site Archive System** shall be periodically synchronized with the **Off-site Archive System**.

During the nominal phase, no services will be deployed onsite for the scientific data archive (Bulk and Science data Archives) but only a subset of the Science Data Archive to execute the short-term observation plan.

**[ASTRI-9.2.0.0-2060]** A subset of the **Science Archive**, needed to execute the short-term observation plan, shall be deployed at the **Site Archive System**.

**[ASTRI-9.2.0.0-2070]** Raw Cherenkov camera data shall be stored in a **Local Bulk Repository** on-site and immediately transferred to the offsite **Bulk Archive**.

During the AIV/SVP phases a reduced version of the **Bulk** and **Science Archives** will be deployed onsite, in order to manually run the MA data reduction and analysis.

A functional decomposition of the whole **Archive System** is shown in Fig. 48.

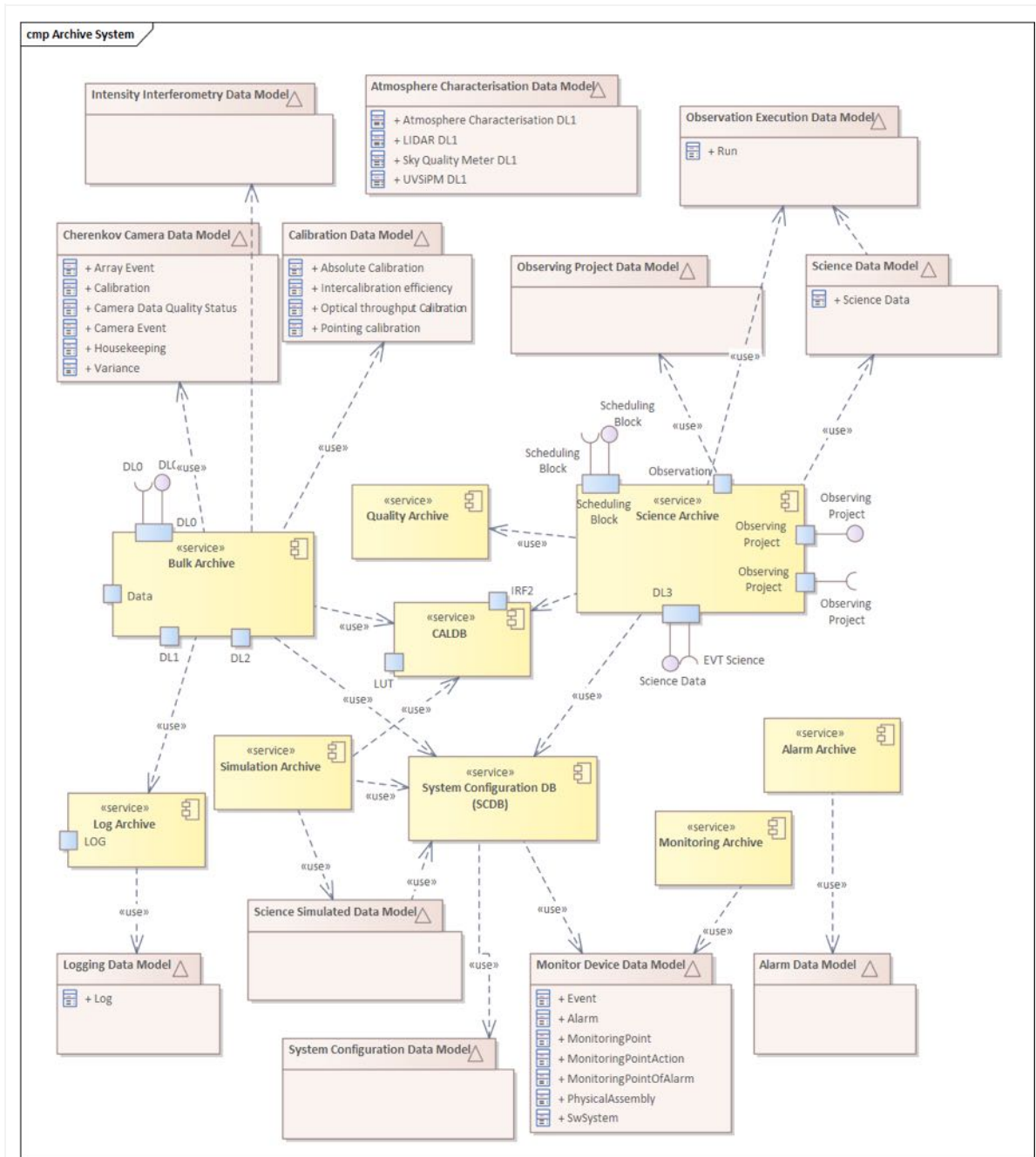

**Figure 48:** Archive System and its relationship with the Data Models (see [AD2]).

## 5.4. Data Processing System

[ASTRI-9.3.0.0-2000] The **Data Processing system (DPS)** shall calibrate and reduce the acquired scientific data and generate quick look scientific results automatically.

[ASTRI-9.3.0.0-2002] The **DPS** shall be used to check the quality of the final data products.

[ASTRI-9.3.0.0-2004] The **DPS** shall have the following components:

1. **Stereo Event Builder:** performs the off-line software stereo array trigger of Cherenkov data;
2. **Cherenkov Data Pipeline:** data calibration, reconstruction, selection, and scientific analysis of Cherenkov data;
3. **Intensity Interferometry Data Pipeline:** data reconstruction and scientific analysis of Intensity Interferometry data.

Fig. 49 shows the **Data Processing System** functional diagram for the **Stereo Event Builder** and the **Cherenkov Data Pipeline** components. The functional decomposition for the Intensity Interferometry Data Pipeline is separately shown in Fig. 50.

A preliminary step for the proper execution of the Cherenkov data reduction chain is the execution of the **Cherenkov Camera Pre-processing** (see Sect. [5.2.8.1](#)). This is executed as soon as the Cherenkov camera raw data is transferred and archived in the offsite Data Center.

The **Cherenkov Camera Data Model** defines the collection of information generated during the Cherenkov data acquisition and data processing. The **Stellar Intensity Interferometry Instrument Data Model** defines the collection of information generated during the data acquisition and during the Intensity Interferometry data acquisition and processing.

The **Science Data Model** (see [AD2]) defines the collection of all the information recorded during an observation (Cherenkov, auxiliary and engineering data) that are needed for the scientific analysis. The Science Data Model (SDM) also allows establishing the relationship between acquired data and Observing Projects, and to trace all deduced astronomical properties back to the raw instrumental data.

Cherenkov Camera or SI<sup>3</sup> data are stored and retrieved from the **Bulk Archive**. The results of the Data Processing System are saved in the **Science Archive** (see Sect. [5.3](#)).



**Simulations** of Cherenkov data are also used as input of the system and are treated in the same way (see Sect. [5.6](#)). The **Science Simulated Data Model (SSDM)** defines the collection of information generated through MC simulations, used for the characterization of the Cherenkov events and the definition of the expected array performances through the instrument response functions needed for scientific analysis. Cherenkov simulations data and calibration event data are stored and retrieved from the **Simulation Archive**.

Science Data Model and Science Simulation Data Model are retrieved from the **Science Archive**.

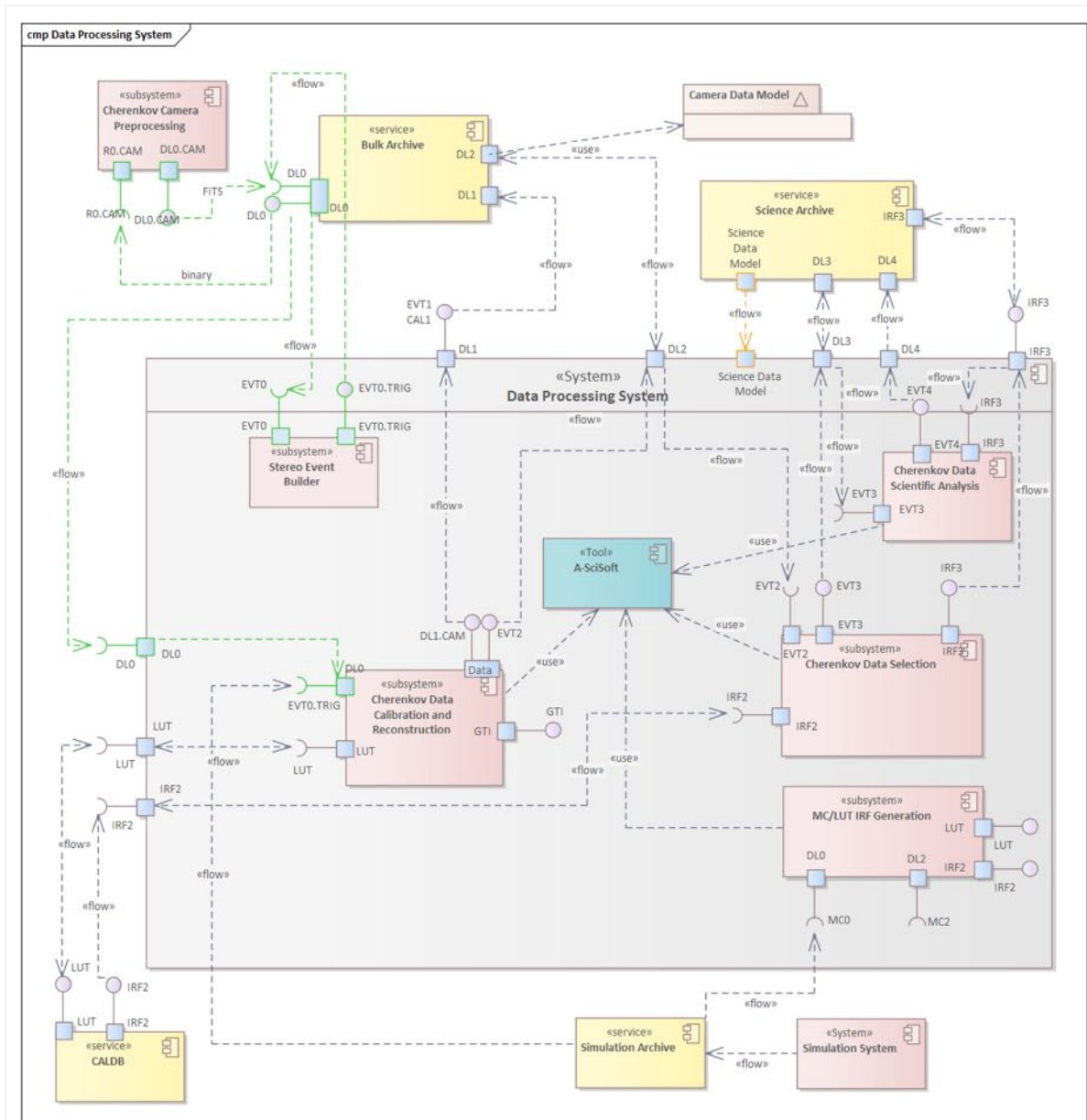
A calibration database, **CALDB** (see Sect. [5.3](#)), is connected with the **Data Processing System** to store and retrieve calibration information, look-up-tables and IRFs.



**Figure 49:** Data Processing System for the Cherenkov Data Pipeline. The Science Data Model flow is not shown because it is connected with all components of the schema. The same occurs for the Science Simulated DM, which is directly linked with the Science DM. The *MC LUT/IRF Generation* component is connected with the CALDB (not shown in the figure).

		<b>ASTRI Mini-Array</b> Astrofisica con Specchi a Tecnologia Replicante Italiana					
	<b>Code:</b> ASTRI-INAF-DES-2100-001	<b>Issue:</b>	2.5	<b>Date:</b>	Jun 18, 2021	<b>Page:</b>	102/119

#### 5.4.1. Stereo Event Builder and off-line software array trigger

The Cherenkov cameras of the MA telescopes will trigger locally (i.e., independently of other telescopes). The array trigger acts on information sent by each triggered telescope to select Cherenkov shower signatures and distinguish background processes (like hadrons and muons) using stereoscopic information. A stereo array trigger occurs when a time coincidence between at least two telescopes within a predefined time window is found. To perform this task, an off-line (after the data acquisition) software stereo array trigger will be implemented.

The **Stereo Event Builder** manages the Cherenkov Camera Data Model (see [AD2]).

[ASTRI-9.3.0.0-2010] The **Stereo Event Builder** shall perform the off-line software stereo array trigger of Cherenkov data.

[ASTRI-9.3.0.0-2020] The **Stereo Event Builder** shall retrieve data from the **Bulk Archive** and save results to the **Bulk Archive**.

[ASTRI-9.3.0.0-2030] The **Stereo Event Builder** shall collect data from the individual telescopes. The input of the Stereo Event Builder shall include DLO data, telescope trigger timestamps plus other information like the status of the telescope at the time the trigger was produced. Inputs shall be sorted by time and coincidences searched for timestamps on the basis of a time coincidence window that contains a predefined minimum number of telescopes.

[ASTRI-9.3.0.0-2040] The **Stereo Event Builder** shall assign a unique identifier to each stereo event.

[ASTRI-9.3.0.0-2050] The **Stereo Event Builder** shall have a programmable time coincidence window.

[ASTRI-9.3.0.0-2060] The **Stereo Event Builder** shall have a programmable minimum number of telescopes for each time coincidence window.

[ASTRI-9.3.0.0-2070] The **Stereo Event Builder** shall implement an array trigger flexible enough to preserve background events, such as muon rings, that are useful for calibration purposes.



[ASTRI-9.3.0.0-2080] The **Stereo Event Builder** shall run off-line at the MA Data Center (after the data acquisition).

#### 5.4.2. Cherenkov Data Pipeline

The **Cherenkov Data Pipeline** processes the Cherenkov Camera Data Product Model, the Science Data Model and the Science Simulated Data Model (see [AD2]).

[ASTRI-9.3.0.0-2100] The **Cherenkov Data Pipeline** shall be used for:

1. generation of short-term data products/processing results to give feedback to the Operator and Astronomer on-duty (Level-B Data Processing category, see [AD2], ref. ASTRI-UC-0-090 [AD3]);
2. generation of final (long-term) data release products/processing data products of Cherenkov data (Level-C Data Processing category, see [AD2], ref. ASTRI-UC-0-090 [AD3]);
3. generation of automated science products (ref. ASTRI-UC-0-120 [AD3]).

		<b>ASTRI Mini-Array</b> Astrofisica con Specchi a Tecnologia Replicante Italiana					
	<b>Code:</b> ASTRI-INAF-DES-2100-001	<b>Issue:</b>	2.5	<b>Date:</b>	Jun 18, 2021	<b>Page:</b>	103/119

**[ASTRI-9.3.0.0-2110]** The **Cherenkov Data Pipeline** shall perform the data reduction of both real (EVT) and simulated Monte Carlo (MC) data.

**[ASTRI-9.3.0.0-2120]** The **Cherenkov Data Pipeline** shall provide all necessary software tools to reconstruct the physical characteristics of astrophysical gamma rays (and background cosmic rays) from the raw data generated by the MA telescopes. The software shall implement every algorithm to perform the complete data reduction. The final automated science products shall be produced by means of science tools.

**[ASTRI-9.3.0.0-2130]** The **Cherenkov Data Pipeline** shall merge the results that require data from different Runs.

**[ASTRI-9.3.0.0-2140]** The main components of the **Cherenkov Data Pipeline** shall be:

- 1) Cherenkov Data Calibration and Reconstruction
- 2) Cherenkov Data Selection
- 3) MC/LUT IRF Generation
- 4) Cherenkov Data Scientific Analysis

The full end-to-end MA scientific data reduction and analysis shall be obtained by means of the **A-SciSoft** software package [RD2], developed in the context of the ASTRI Project. The **A-SciSoft** package and the basic components of the MA Data Processing Pipeline will be described in the following sections.

#### 5.4.2.1. A-SciSoft



The **A-SciSoft** tools, developed in the context of the ASTRI-Horn data analysis, shall be used for the ASTRI MA Cherenkov Data Processing and Analysis (see [RD2] for more details). *A-SciSoft* is organized in four distinct functional **breakdown stages (Calibration, Reconstruction, Analysis, and Science)**, which can be executed one after the other as an end-to-end pipeline which allows to reduce data from the raw level (DL0) up to the high-level science-ready data products (DL3) related to the Observing Project.

DL3 data shall be analysed by means of science analysis tools (**Science Tools**) to get the final science products (DL4) by the **Science User** or, in an automated way, directly by the **Data Processing System** at the end of the short- and long-term pipeline processing. Science Tools might be developed *in-house* and included in the *A-SciSoft* package or, alternatively, publicly available software tools already developed for the analysis of imaging Cherenkov data can be used for the analysis of the ASTRI MA data.

#### 5.4.2.2. Cherenkov Data Calibration and Reconstruction

**[ASTRI-9.3.0.0-2150]** The **Cherenkov Data Calibration and Reconstruction** component shall perform the following steps: (i) event calibration (from DL0 to DL1a), and (ii) reconstruction (from DL1a to DL2b).

**Calibration (DL0 → DL1a).** The MA raw Cherenkov camera images, containing the full information available per each camera pixel (integrated signal amplitude in analog-to-digital converted (ADC) counts and, if available, arrival time) for each triggered event are calibrated (separately for each

		<b>ASTRI Mini-Array</b> Astrofisica con Specchi a Tecnologia Replicante Italiana					
	<b>Code:</b> ASTRI-INAF-DES-2100-001	<b>Issue:</b> 2.5	<b>Date:</b> Jun 18, 2021	<b>Page:</b> 104/119			

telescope) in order to extract and convert the signal into physically meaningful units (photo-electrons [pe]). The conversion coefficients are extracted from specific camera calibration data (CAL0) and/or directly from **CALDB** [RD4]. **Science Data Model** is needed for scientific analysis and data-quality checks.

**Reconstruction (DL1a → DL2b).** The characterisation of each Cherenkov event triggered by the system is done both on a telescope-wise basis and an array-wise basis.

- **Telescope-wise reconstruction:** The calibrated images of each triggered telescope undergo a cleaning procedure aimed at removing pixels which most likely do not belong to a given Cherenkov shower image. After this step, the Hillas parameterization of each resulting cleaned image is performed [RD5]. The extracted parameters are mainly based on the statistical moments, up to the third order, of the light distribution on the camera, and on arrival time information (if available). In this step, the telescope pointing and source position are extracted from the technical data and associated with each image. Once the events recorded by each telescope are cleaned and parameterized, a set of simulated gamma-ray data and a set of real or MC background data are used to train a machine learning algorithm for the calculation of suitable single-telescope (ST) look-up-tables (LUT) for gamma/hadron separation, energy reconstruction, and arrival direction estimation. Once available, these LUTs are applied to the ST parameterized images to get the fully telescope-wise reconstructed data<sup>1</sup>.
- **Array-wise reconstruction.** The telescope-wise fully reconstructed data of each telescope are merged and a set of basic array-wise image parameters per event (such as the geometrical estimation of the shower direction, the maximum height, and the impact parameters relative to each telescope) are calculated. Once available, a set of simulated gamma-ray data and a set of real or MC background data are used to compute the array-wise look-up-tables for gamma/hadron separation, energy reconstruction, and arrival direction estimation of the stereo event. In this step, both telescope-wise and array-wise pieces of information can be used together to train the machine learning method. Finally, the array LUTs are applied to the data to get the fully reconstructed Cherenkov stereo events. At this level of the analysis, array-wise parameters for the gamma/hadron separation, energy reconstruction, and arrival direction estimation are available for each fully reconstructed event. In particular, the gamma/hadron separation parameter is then evaluated.



**[ASTRI-9.3.0.0-2160]** The data products of the Cherenkov Data Calibration and Reconstruction system (calibration factors, calibrated and reconstructed Cherenkov events) shall be archived into the **Bulk Archive** and in the **CALDB**.

#### 5.4.2.3. Cherenkov Data Selection

**[ASTRI-9.3.0.0-2170]** The **Cherenkov Data Selection** component shall perform the generation of the stereo event-list (from DL2b to DL3) and the IRF3 generation.

**Event Selection (DL2b → DL3).** The fully reconstructed stereo events are further processed to achieve the fully reduced event list. At this stage, the final gamma-like event-list (EVT3) is produced, extracted from the corresponding EVT2b, along with the corresponding reduced IRF3 (from the corresponding IRF2). In this last analysis step, both quality and gamma/hadron separation cuts are

<sup>1</sup>In the case of the MA data processing, the telescope-wise event reconstruction is not strictly necessary and, after the cleaning and parameterization of the single-telescope images, the reconstruction of the full stereo event parameters can be performed.

		<b>ASTRI Mini-Array</b> Astrofisica con Specchi a Tecnologia Replicante Italiana					
	<b>Code:</b> ASTRI-INAF-DES-2100-001	<b>Issue:</b>	2.5	<b>Date:</b>	Jun 18, 2021	<b>Page:</b>	105/119

applied to get the final DL3 data. Good time intervals (GTI) are also computed and provided together with the event-list and the IRFs.

**[ASTRI-9.3.0.0-2180]** The data products of the **Cherenkov Data Selection** (event-lists and high-level IRFs) shall be archived into the **Science Archive**.

**[ASTRI-9.3.0.0-2190]** The data products of the **Cherenkov Data Selection** shall be used to achieve the scientific performance verification/validation.

#### 5.4.2.4. MC/LUT IRF Generation

**[ASTRI-9.3.0.0-2200]** The **MC LUT/IRF Generation** component shall generate LUTs and low-level global instrumental response functions IRF2 for Cherenkov data reconstruction and scientific analysis.

Using a set of simulated gamma-ray data and a set of real or MC background data, the tool shall train a machine learning algorithm for the calculation of suitable single-telescope or array-wise LUTs used for gamma/hadron separation, energy reconstruction, and arrival direction estimation of the Cherenkov events. IRF2 includes: effective collection area, energy and angular resolution, and residual background rate (as a function mainly of energy, zenith and azimuth pointing, and gamma-ray source position).

**[ASTRI-9.3.0.0-2210]** The data products of the **MC/LUT IRF Generation** (LUTs and low-level IRFs) shall be archived into the scientific calibration database (CALDB).



#### 5.4.2.5. Cherenkov Data Scientific Analysis

**[ASTRI-9.3.0.0-2220]** The **Cherenkov Data Scientific Analysis** component shall be used to analyze DL3 data to get, in an automated way, preliminary and final science products (DL4) from the Data Processing System, such as detection plots, spectra, sky-maps, and light-curves, starting from the fully reduced data (EVT3/IRF3). These products, if needed, can be further processed and merged to get high-level data (DL5), which include legacy data, such as survey sky-maps and/or source catalogs.

**[ASTRI-9.3.0.0-2230]** Automated science products (DL4) shall be obtained by means of appropriated and approved Science Tools.

**[ASTRI-9.3.0.0-2240]** The data products of the **Cherenkov Data Scientific Analysis** (science products, like detection plots, sky-maps) shall be archived into the **Science Archive**.

The typical duration of the Cherenkov data analysis depends on the event rate and the data taking time per each run. For a typical event rate of 150 Hz and a (fixed) run duration of 15 min, it takes roughly 3.75 min to reduce the scientific data from DL0 to DL3 plus a few seconds more to generate the science products (DL4 data). In general, @150 Hz the Data Processing Time (DPT) of the ASTRI Cherenkov Data Pipeline is ~1/4 of the Data Taking Time (DTT).

		<b>ASTRI Mini-Array</b> Astrofisica con Specchi a Tecnologia Replicante Italiana					
	<b>Code:</b> ASTRI-INAF-DES-2100-001	<b>Issue:</b>	2.5	<b>Date:</b>	Jun 18, 2021	<b>Page:</b>	106/119

### 5.4.3. Intensity Interferometry Data Pipeline

The functional decomposition of the **Intensity Interferometry Data Pipeline** is shown in Fig. 50. The **Intensity Interferometry Data Pipeline** processes the Stellar Intensity Interferometry Instrument Data Model and the Science Data Model (see [AD2]).

[ASTRI-9.3.0.0-2000] The **Intensity Interferometry Data Pipeline** shall process and analyze the data acquired by the SI<sup>3</sup>.

[ASTRI-9.3.3.0-2020] The main components of the **Intensity Interferometry Data Pipeline** shall be:

- 1) Intensity Interferometry Data Reconstruction
- 2) Intensity Interferometry Data Scientific Analysis

#### 5.4.3.1. Intensity Interferometry Data Reconstruction

[ASTRI-9.3.3.1-2030] The **Intensity Interferometry Data Reconstruction** shall determine the time tags of each event from the raw (DL0) data acquired with the Time-to-Digital-Converter (TDC, where the signal of the SI<sup>3</sup> is sent). The reconstruction of the time tags shall make use of the reference signal and the pulse-per-second (PPS) signal provided by the White Rabbit board to the TDC, and saved together with the photon events in the data stream. This is done independently for each telescope.

[ASTRI-9.3.3.1-2040] The **Intensity Interferometry Data Reconstruction** shall implement all algorithms needed to perform the complete data reconstruction from the input DL0 data in binary format to the higher level DL2 data consisting in event lists referred to UTC. The algorithm shall perform the following steps: (i) event list reconstruction (from DL0 to DL1), (ii) calibration of the time tags (from DL1 to DL2). In step (i), reference signals shall be identified, and used to count and join one after the other the continuous acquisition intervals of the TDC (that have a fixed duration of 8 ms). In step (ii), the drift of the clock shall be removed interpolating the PPS signals, and time tags referred to UTC are calculated from the PPS-corrected event lists.

#### 5.4.3.2. Intensity Interferometry Data Scientific Analysis

[ASTRI-9.3.3.2-2050] The **Intensity Interferometry Data Scientific Analysis** shall perform the generation of the higher level data products. The software shall implement all algorithms needed to perform the calculation of the diagram of the temporal correlation per each pair of telescopes. This is done independently for all pairs of telescopes (36 baselines).

[ASTRI-9.3.3.2-2060] The **Intensity Interferometry Data Scientific Analysis** shall generate the final DL4 scientific data products, starting from the DL2 output level data products of the **Intensity Interferometry Data Reconstruction**. The algorithm shall perform the following steps: (i) checking and cleaning of the event lists (from DL2 to DL2a data), (ii) segmentation of the event lists (from DL2a to DL2b data), (iii) calculation of the time coincidences (from DL2b to DL3 data), (iv) calculation of the diagram of the temporal correlation (from DL3 to DL4 data). In step (i), 1s-binned light curves are calculated and checked for intervals of unusable data (because of, e.g., passing clouds, technical problems, etc.). To remove them from the final analysis, suitable time cuts are applied to the event lists. In step (ii), the cleaned event lists collected from each telescope are divided in segments. In step (iii), segments from pairs of different telescopes are correlated searching for coincidences in the events arrival times. To calculate the coincidences, the time tags of the detected photons shall be

corrected for the continuously changing geometric optical path delay between any two telescopes. The output at this level consists of tables of coincidences for each segment and for each pair of telescopes. In step (iv), the diagrams of the temporal correlations are calculated for each pair of telescopes averaging all the segments. The final scientific analysis shall be performed on these high level data (consisting of ASCII tables and plots).

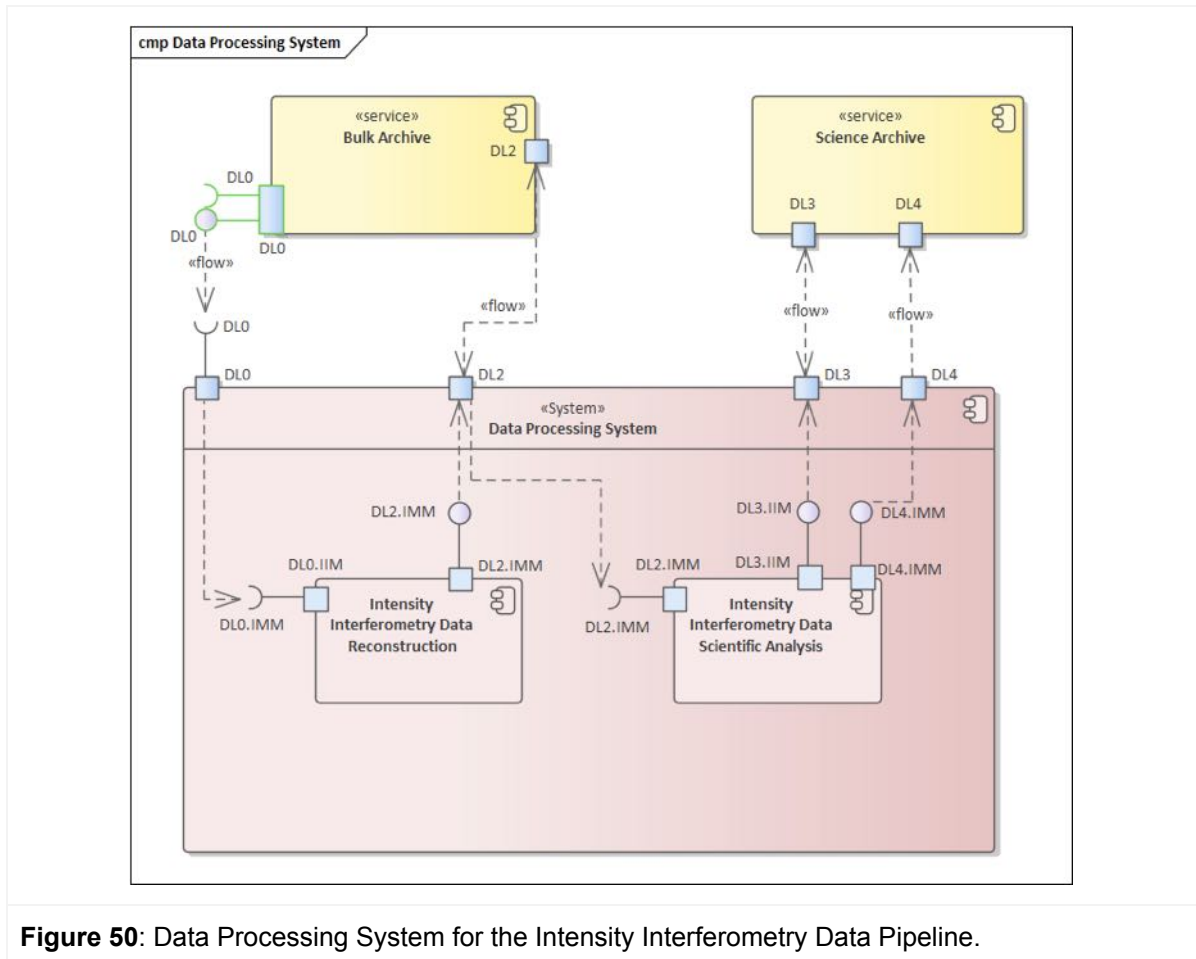

**Figure 50:** Data Processing System for the Intensity Interferometry Data Pipeline.

## 5.5. Science Support System

The functional decomposition of the **Science Support System** is reported in Fig. 47. The Science Support System manages the Observing Project Data Model and the Science Data Model (see [AD2]).

[ASTRI-9.4.0.0-2010] The **Science Support System (SSS)** shall provide the main point of access for the exchange of science-related data and information with the **Science Users**, and shall support the whole science-related workflow, from the *Observing Project* submission to the access to the archived high-level MA science-ready data products and the corresponding Science Tools to support the data analysis.

[ASTRI-9.4.0.0-2020] The main functional blocks of the **SSS** shall be:

- **Observing Project Handler**: to submit *Observing Projects*, to store the *observation plans* and to select the *short-term observation plans* for the next night;
- **Observation Scheduler**: to support the preparation of the *observation plans*;
- **Science Gateway**: to retrieve science-ready data and science tools.

[ASTRI-9.4.1.0-2030] The **Observing Project Handler** shall be used by the **Science User** for the *Observing Project* preparation.

[ASTRI-9.4.1.0-2040] The **Observing Project Handler** shall provide a web interface that allows ASTRI **Science Users** to submit *Observing Projects* finalized to perform scientific, technical, calibration and intensity interferometry observations with the ASTRI MA.

[ASTRI-9.4.1.0-2045]. The **Observing Project Handler** shall permanently store all the *Observing Projects* into the **Science Archive**.

[ASTRI-9.4.4.0-2050] The **Observation Scheduler** shall provide a **Visibility Checker** and a **Sensitivity Calculator** software tools, used, respectively, to check the visibility of the proposed target and, giving the expected IRFs produced using the MC simulated data, to provide an estimate of the observation time needed to reach the scientific goal of the proposal.

[ASTRI-9.4.4.0-2055] The **Observation Scheduler** shall take care that all the target visibility and observability constraints specified for the ASTRI MA system (maximum allowed zenith range, duration of the observation, ...) are fulfilled during the preparation of both the long- and the short-term observation plans.

[ASTRI-9.4.4.0-2060] The **Observation Scheduler** shall be used by the **Support astronomer** to prepare the *long-term observation plans*. The input is the list of approved *Observing Projects*, and the output are the *Scheduling Blocks*.

[ASTRI-9.4.4.0-2065] The **Observation Scheduler** shall permanently store the *long-term observation plans* and the *Scheduling Blocks* into the **Science Archive**.

[ASTRI-9.4.4.0-2070] The **Observation Scheduler** shall be used by the **Support Astronomer** to prepare the *short-term observation plan* of targets to be observed during each night. The input is the *long-term observation plan* of the *Observing Projects*, and the outputs are the *Scheduling Blocks* of the observing night.

**[ASTRI-9.4.4.0-2075]** The **Observation Scheduler** shall permanently store the *short-term observation plans and the Scheduling Blocks* into the **Science Archive**.

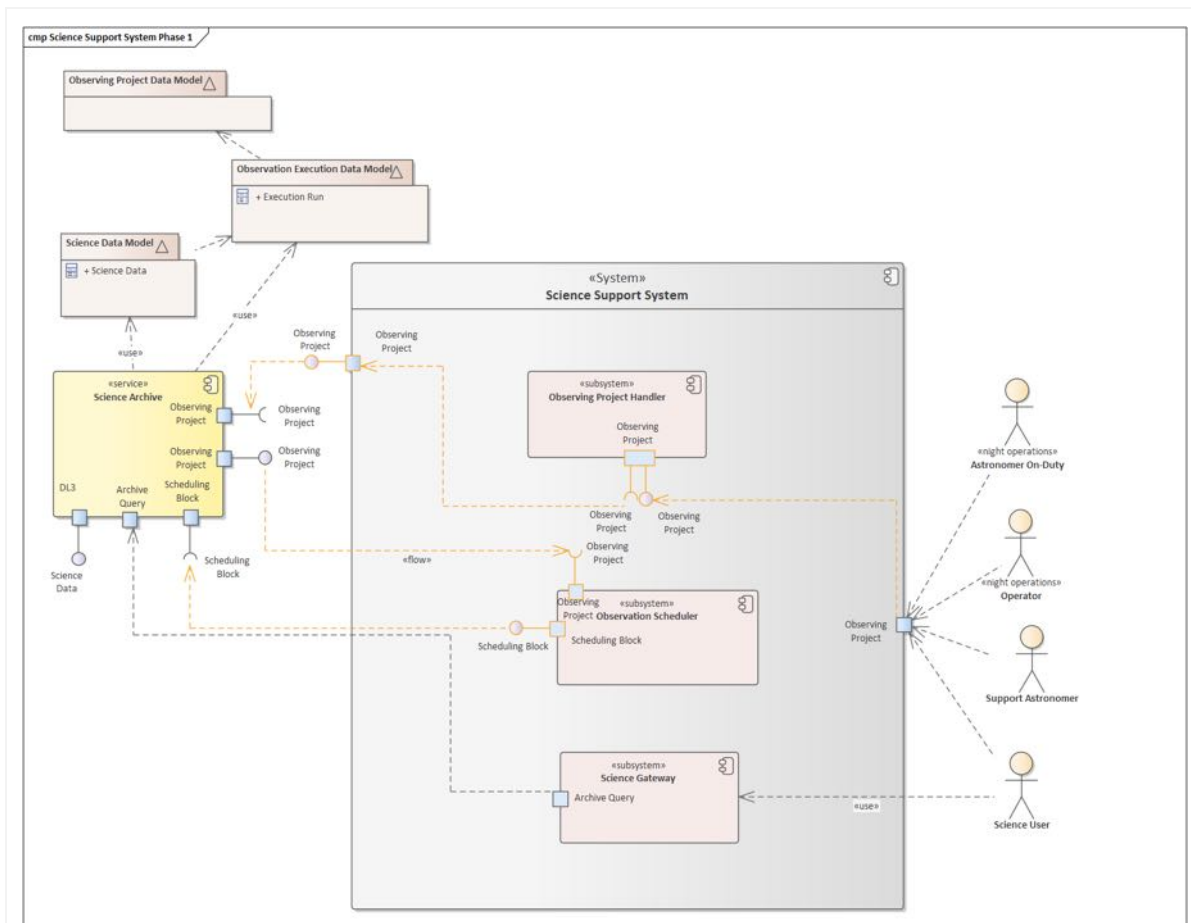

**[ASTRI-9.4.1.0-2080]** The **Observing Project Handler** and the **Observation Scheduler** shall be used by the **Astronomer on-duty** to prepare the Observing Projects templates to perform ToO observations.

**[ASTRI-9.4.3.0-2100]** The **Science Gateway** shall be a web interface used to access high-level science-ready data (event-lists and IRFs) and data products produced by the **Data Processing system**. When data becomes available, the ASTRI **Science Users** shall be informed, and shall be able to query and download the data together with Science Tools for their scientific exploration.



**Figure 51:** Science Support System.

In future developments, it may be possible to interact with the external scientific community if the ASTRI experiment distributes Announcement of Opportunity (if activated) and to exchange information on MM/MWL observations through services provided by this system.

		<b>ASTRI Mini-Array</b> Astrofisica con Specchi a Tecnologia Replicante Italiana					
	<b>Code:</b> ASTRI-INAF-DES-2100-001	<b>Issue:</b>	2.5	<b>Date:</b>	Jun 18, 2021	<b>Page:</b>	110/119

## 5.6. Simulation System

The functional decomposition of the **Simulation System** is reported in Fig. 52. The **Science Simulated Data Model** is described in [AD2].

Simulations of air shower Cherenkov events using Monte Carlo methods are an essential component of any imaging atmospheric Cherenkov telescope (IACT) project in all phases of its life. Simulations are mandatory, in particular during the operational phase, to train the background rejection strategies since no artificial gamma-ray test-beam is available to calibrate the telescope array. They are also needed to estimate the instrument response functions and to test the data reconstruction and the scientific analysis software. The shower development in the atmosphere for both gammas and background particles need to be carefully simulated, followed by a detailed simulation of the atmospheric extinction and the detector response.

**[ASTRI-9.5.0.0-2010]** The **Simulation System** shall generate simulated Cherenkov events induced by primary gamma-rays and background particles using Monte Carlo methods.



**[ASTRI-9.5.0.0-2020]** The **Simulation System** shall have the following components:

1. MC particle and gamma production: simulation of extensive atmospheric showers induced by primary gamma-rays and background particles;
2. Array and instrument response simulation: simulation of the telescope and array response to the Cherenkov photons produced in the extensive atmospheric showers, including Cherenkov camera photo-detection and full electronic analog-to-digital conversion chain response;
3. MC calibration events production: simulation of events (atmospheric muons, pulsed light sources, ...) used for telescope and array calibration purposes.

For the ASTRI MA MC simulation productions, the same simulation chain commonly used by the CTA consortium will be adopted for ease of comparison and consistency. Atmospheric showers will be simulated using the *CORSIKA* code [RD8] (**MC particle and gamma production**), while the telescope response will be simulated with the *sim\_telarray* package [RD9], which propagates Cherenkov photons hitting the primary mirror through the telescope optical system up to the Cherenkov camera and then simulates the photon detection, the electronic response, and the camera trigger logic (**Array and instrument response simulation**).

To properly estimate the performance of the ASTRI MA, we will need to simulate both gamma-ray initiated events and background events, that is events initiated by charged primaries, mainly protons, and electrons. Heavier cosmic nuclei contribute sizably to the overall trigger-rate but are rejected very efficiently by the usual gamma/hadron discrimination techniques and therefore their contribution to the irreducible background is negligible. Due to the much larger background flux with respect to that of any known gamma-ray source and to the very efficient background rejection achieved by the IACT technique, very sizable samples of background events are needed to derive the expected array performance. Gamma-ray initiated events coming from a well-defined direction are simulated to estimate the performance of the IACT array while observing point-like gamma-ray sources. Diffuse gamma-rays are simulated instead to estimate IRF for off-axis observations and the expected performance while observing extended gamma-ray sources.

For calibration purposes other kinds of simulated events are needed, like events due to muon-tracks in the atmosphere or pulsed light sources (**MC calibration events production**).

		<b>ASTRI Mini-Array</b> Astrofisica con Specchi a Tecnologia Replicante Italiana					
	<b>Code:</b> ASTRI-INAF-DES-2100-001	<b>Issue:</b>	2.5	<b>Date:</b>	Jun 18, 2021	<b>Page:</b>	111/119

Due to the relevant computing resources needed to perform a full MC production, the ASTRI MA simulation sw chain shall be executed preferably on a GRID infrastructure (or, in the alternative, at the Data Center computing farm).

[ASTRI-9.5.0.0-2030] The **Simulation System** shall store the whole MA production on the **Simulation Archive**.

[ASTRI-9.5.0.0-2040] The **Simulation System** shall read the simulation configuration from the **System Configuration DB (SCDB)**.

[ASTRI-9.5.0.0-2050] The **Simulation System** shall provide up-to-date information of the simulation configuration to the **SCDB**.

[ASTRI-9.5.0.0-2060] The **Simulation System** shall provide an output file format of the simulations compatible with the input file format of the **Data Processing System**.

Simulations are processed with the **Data Processing System** (Sect. [5.4](#)).

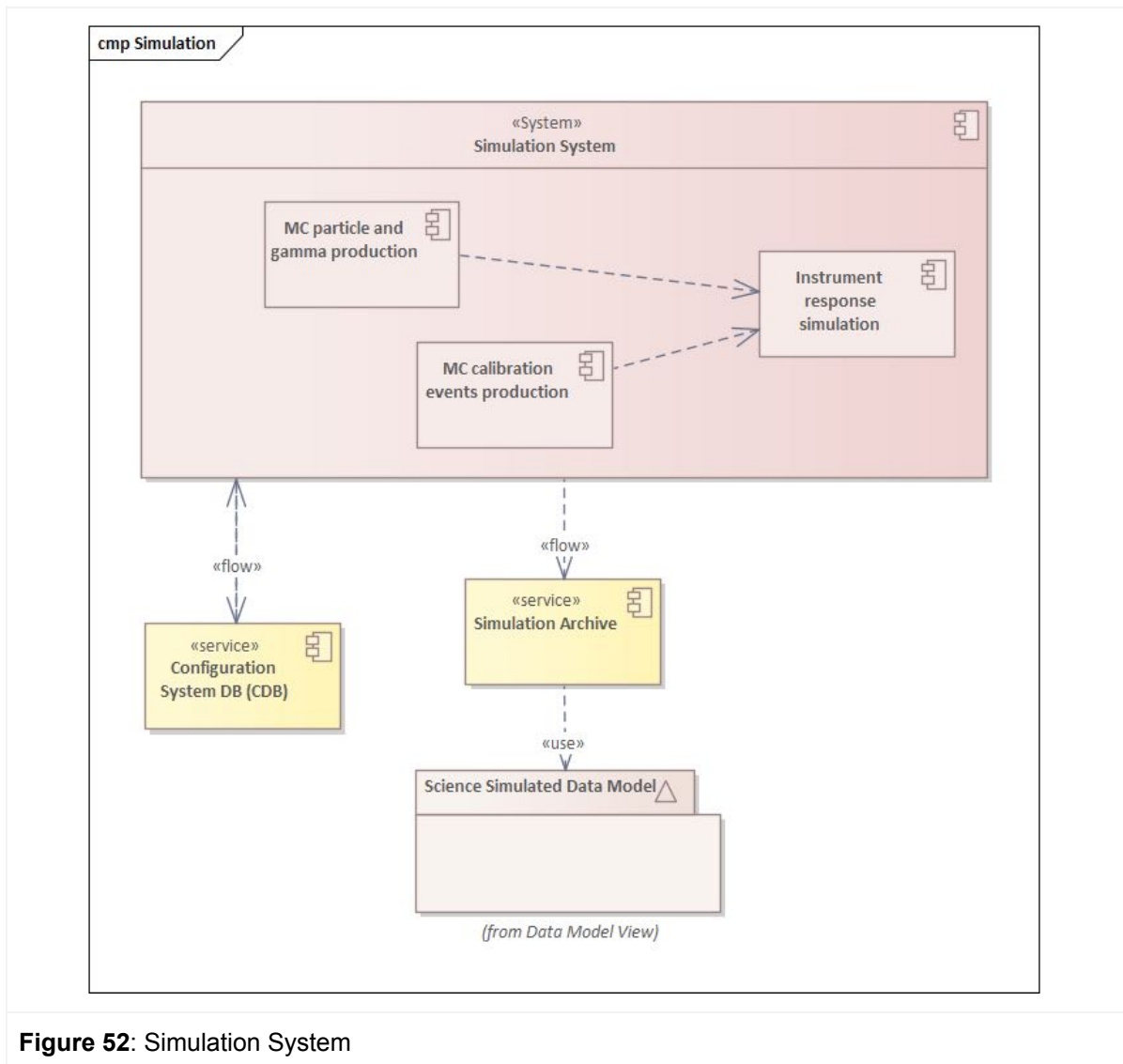
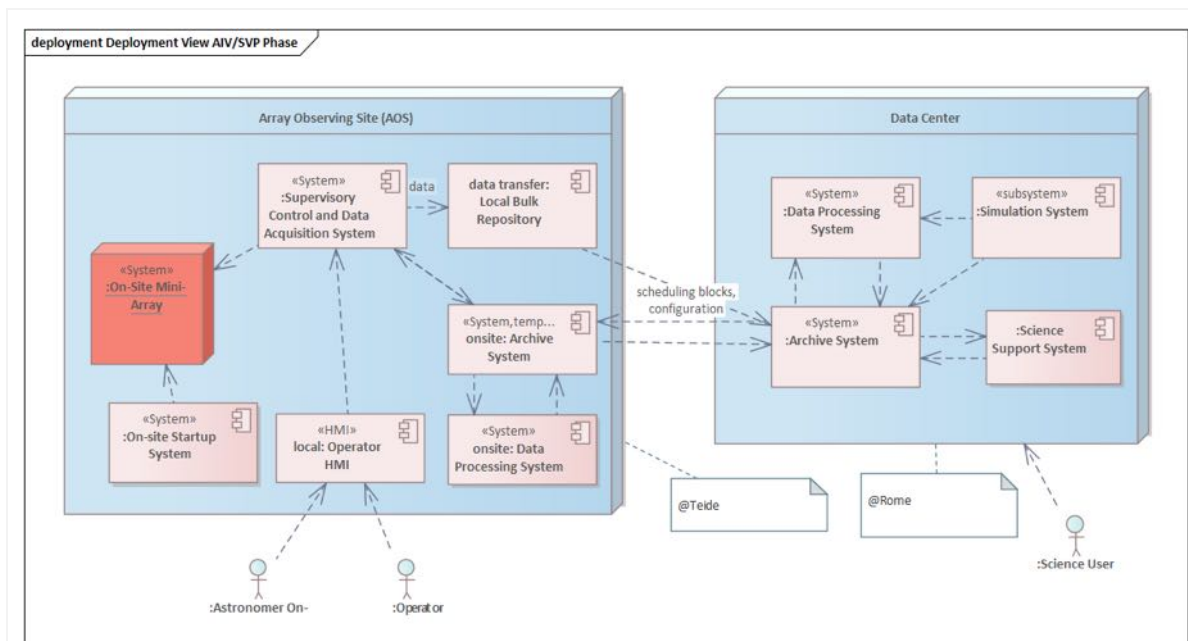

**Figure 52:** Simulation System





## 6.2. ASTRI MA Deployment View in AIV/SVP phases

The ASTRI MA Deployment View in AIV/SVP phases is shown in Fig. 54.



**Figure 54:** Deployment View in AIV/SVP phase.

		<b>ASTRI Mini-Array</b> Astrofisica con Specchi a Tecnologia Replicante Italiana					
	<b>Code:</b> ASTRI-INAF-DES-2100-001	<b>Issue:</b>	2.5	<b>Date:</b>	Jun 18, 2021	<b>Page:</b>	115/119

## 7. Constraints and quality requirements

### 7.1. Uniformity Requirement: Adherence to Software Framework

The MA software system development will be distributed among a number of INAF institutes and external contractors.

The system operations will be geographically distributed among the observing site with the nine telescopes, separated by hundreds of meters, the data center distant hundreds of kilometers from the observing site, and AOCs. This being the case, ensuring that the system produced has a high level of consistency and coherence is an absolute priority. Code that essentially does the same thing in different modules should be done in the same way everywhere, e.g., access to one node from another, logging methods and formats.



Software frameworks offer a unified programming model and common services such as logging, event handling, alarms and location transparency (run-time software components can be relocated from one node to another at runtime if needed, e.g., for load balancing). The use of such frameworks is common among many astronomical observatories.

1. The on-site MA SCADA control software system shall be built atop the same framework that has been successfully used by ALMA, namely, the ALMA Common Software (ACS). ACS is a container component framework, designed for distributed systems, with standardized paradigms for logging, alarms, location transparency, and support for multiple programming languages: Java, C++ and Python. *The appropriate version of ACS shall be made available to all developers before the start of detailed design and implementation.*
2. The MA Control Systems shall implement a device-to-SCADA interface based on the IEC 62541 standard for the OPC Unified Architecture protocol. It is one of the most important communication protocols for Industry 4.0 and the Internet of Things. OPC-UA allows access to machines, devices and other systems in a standardized way and enables similar and manufacturer-independent data exchange. It is open source (GPL 2.0), well documented and secure.

### 7.2. System Software Tools and run-time environments requirements

The following list of tools and run-time environments shall be used during the development, testing and maintenance phases of the MA life cycle:

1. **Operating Systems:** CentOS 8.x - ubuntu systems for Off-site (services).
2. **Middleware** for SCADA System: ALMA Common Software (ACS, latest available version running on CentOS 8.x), Kafka
3. **Programming Languages for SCADA System:** those supported by ACS, namely Java OpenJDK version 11 or above, Python 3.6.9 or above, C++ (the ACS-supported versions).
4. **Programming Languages for PLC, PC/PLC:** The Functional Block Diagram and Structured Text languages that are two of the five PLC programming languages defined in the Standard IEC 61131 section 3.
5. **Programming Languages** for the Data Processing System: ANSI-C, C++, Python.
6. Other languages subject to prior approval.
7. **Control protocol device-to-SCADA interface:** OPC UA defined in IEC 62541 standard (see [RD3]).
8. **Software Version Control System:** git.

		<b>ASTRI Mini-Array</b> Astrofisica con Specchi a Tecnologia Replicante Italiana					
	<b>Code:</b> ASTRI-INAF-DES-2100-001	<b>Issue:</b>	2.5	<b>Date:</b>	Jun 18, 2021	<b>Page:</b>	116/119

9. **Virtualizer** for the off-site ICT: ovirt
10. **Data Transfer Software** between on-site <-> off-site: rsync / aria2
11. **Web Content Managers** off-site archive: django / LAMPy
12. **Alarm System:** ESO Integrated Alarm System. See [RD18, RD19]

Departures from these standards are permissible only in extreme cases and after proposal and shall be approved before implementation (see [AD9]).

## 7.3. Quality Attributes

### 7.3.1. Availability

**[ASTRI-9.0.0.0-1010]** The SCADA shall be available 99% of the time over the course of one observation night.

**[ASTRI-9.0.0.0-1020]** The configuration database shall be available 99.5% of the time in which observations are possible and 98% of the time otherwise.

### 7.3.2. Performance

**[ASTRI-9.0.0.0-1030]** Cherenkov Event data rates: the system shall be able to handle 600 events/second from each of the 9 telescopes, for an array-total event rate of 5400 events/s. After the application of the stereo trigger (offsite and offline), the resulting reduced array-total event rate is expected to be less than or equal to the maximum single-telescope rate. Each Cherenkov event recorded by the telescope cameras will require, including the pixel time information, a size of the order of 13 kBytes.



**[ASTRI-9.0.0.0-1040]** The system shall be designed to support the above Cherenkov Event data rate for the 8 hours of a typical (up to 11 hours for the longest) observing night.

**[ASTRI-9.0.0.0-1050]** The system shall have the capacity to reduce and analyse ~3 TB of scientific Cherenkov RAW data per night (which also include a 10% of calibration, camera house-keeping and variance data as well as service data needed for the Cherenkov data analysis pipeline) produced in the *worst-case* data acquisition scenario (600 Hz of Cherenkov event rate and 11 hours of observations per night) with the full-array in operation and a packet size of 13 kB/event.

**[ASTRI-9.0.0.0-1060]** Monitoring data rate: the system shall support at least 20000 distinct sensors ("monitor points"), at a rate of 1 Hz per sensor.

**[ASTRI-9.0.0.0-1070]** SI<sup>3</sup> event data rates: the system shall be able to handle 100 Mevents/second from each of the 9 telescopes, for an array-total event rate of 900 Mevents/s. This rate is achieved for bright stars. Each event recorded by the SI<sup>3</sup> instrument will require a size of the order of 5 Bytes. The maximum data transfer rate is then 500 MBytes/s.

**[ASTRI-9.0.0.0-1080]** A typical SI<sup>3</sup> monthly observing run totals 3 nights, each lasting 8 hours. The acquisition of bright stars (100 Mevents/second) is limited to 2 hours, while the remaining 22 hours are dedicated to observing average-brightness stars, with a typical event data rate of 20 Mevents/second. Then, the system shall have the capacity to reduce and analyse ~110 TB of

		<b>ASTRI Mini-Array</b> Astrofisica con Specchi a Tecnologia Replicante Italiana					
	<b>Code:</b> ASTRI-INAF-DES-2100-001	<b>Issue:</b>	2.5	<b>Date:</b>	Jun 18, 2021	<b>Page:</b>	117/119

scientific SI<sup>3</sup> RAW data per month (which also include a 2% of SI<sup>3</sup> house-keeping data) produced in the *typical-case* data acquisition scenario (100 MHz event rate and 2 hours of observation plus 20 MHz event rate and 22 hours of observation per monthly run) with the full-array in operation and a packet size of 5 Bytes/event.

**[ASTRI-9.0.0.0-1090]** SI<sup>3</sup> data transfer rate off-site: the system shall be able to transfer off-site the ~110 TB of scientific SI<sup>3</sup> RAW data acquired each month before the start of the following observing run, i.e. in approximately 20-25 days. This constraint turns into a minimum off-site data transfer rate of 400-500 MB/s.

### 7.3.3. Security

**[ASTRI-9.0.0.0-1070]** Each operator-initiated activity shall be traceable to the authorized user who was in control of the array at the time of the activity.

**[ASTRI-9.0.0.0-1080]** Remote control access to the on-site computing infrastructure shall only be possible via a Virtual Private Network whose use is restricted, monitored and logged.

### 7.3.3. Scalability

**[ASTRI-9.0.0.0-1090]** No scaling up of the hardware (e.g., number of telescopes) is foreseen during the lifetime of the project. Upgrade of the computing infrastructure (both at the AOS and at the offsite Data Center) might be foreseen in case of extensions of the MA operations.

### 7.3.4. Portability

**[ASTRI-9.0.0.0-1100]** Beyond the System Requirements given above, portability is not required.

### 7.3.5. Maintainability



While the identification of the staff and/or external personnel to be charged with responsibility for maintenance of the MA software is TBD, it is almost certain that personnel who did not participate in the original development will be employed for significant maintenance tasks.

Therefore, ensuring that the MA software is easy to understand well documented, follows consistent coding practices (e.g., mnemonic variable and method names, individual methods limited to a maximum of order [TBD] 20 lines each, narrow method interfaces. adequate and up-to-date comments) are a high priority.

Maintainability scenarios will be provided in a separate document.

The following subsections enumerate other quality attributes that contribute to maintainability.

#### 7.3.5.1. Testability

		<b>ASTRI Mini-Array</b> Astrofisica con Specchi a Tecnologia Replicante Italiana					
	<b>Code:</b> ASTRI-INAF-DES-2100-001	<b>Issue:</b>	2.5	<b>Date:</b>	Jun 18, 2021	<b>Page:</b>	118/119

**[ASTRI-9.0.0.0-1200]** Every module shall be accompanied by a suite of automated unit tests providing code coverage of at least 95%.

**[ASTRI-9.0.0.0-1210]** Integration tests shall be prepared and required for acceptance.

#### 7.3.5.2. Modifiability

**[ASTRI-9.0.0.0-1220]** Modules and components shall be narrow in their scope, making it possible for a maintainer to identify what area of code needs to be modified without needing to understand the entire software system. Adherence to both the letter and spirit of the provided frameworks shall be mandatory. This will assist developers and maintainers in using existing solutions where they are available, minimize code duplication and, by ensuring that the same actions are performed in the same way throughout the code, avoid surprises to those encountering a particular area of code for the first time.

