

BC-SIM-TR-026 STC ICO3 REPORT

Issue 1.0

Emanuele Simioni¹, Michele Zusi², Romolo Politi², Vania Da Deppo³,
Vincenzo Della Corte², Chiara Casini³, Alessandra Slemmer⁴, Vincent Carlier⁵,
Gabriele Cremonese¹, Fabrizio Capaccioni², Alain Doressoundiram⁵, Yves Langevin⁵,
Pasquale Palumbo⁶, Cristina Re¹, Mathieu Vincendon⁷

¹INAF-OAPD Vicolo Osservatorio 5,35122, Padua, Italy

²INAF-IAPS Via Fosso del Cavaliere 100, 00133, Rome, Italy

³CNR-IFN, via Trasea, 7 , 35131, 00133, Padova, Italy

⁴Officina Stellare S.p.A, Via della Tecnica 87/89, 36030 Sarcedo (VI)

⁵Institute d'astrophysique spatiale , Bâtiment 121, Université Paris-Sud 91405 Orsay

⁶Università Parthenope, Centro Direzionale Isola 4, Naples, Italy

⁷LESIA (Observatoire de Paris - PSL, Laboratoire d'Études Spatiales et d'Instrumentation en Astrophysique), 92195 Meudon Cedex, France

Index

Index.....	2
Approval.....	3
Document change record.....	3
1. Introduction.....	4
1.1. Scope.....	4
1.1. Reference Document.....	5
1.1. Acronyms.....	6
1.2. Document Format and Repository.....	7
1.3. Document Organization.....	7
2. Definitions and assumptions	8
2.1. STC Sensors.....	8
3. STC-ICO3 Tests.....	10
3.1. TEC Parameters.....	10
3.2. Heating and Cold Fingers	11
4. STC Functional Test.....	14
4.1. Test description	14
4.2. Commanding	14
1.1. HKs interpretation and discussion	15
5. STC Performance Test.....	18
5.1. Test description	18
5.2. Commanding	18
5.3. HKs interpretation and discussion	21
6. STC-HRIC Interference test	24
6.1. Test description	24
7. Attached documents	25
7.1. Performance Report	25
7.2. TIMING LOG Report.....	26

Approval

Prepared by:	Emanuele Simioni
	Michele Zusi
Revised by:	Gabriele Cremonese
	Cristina Re
	Vania Da Deppo
Approved by:	Gabriele Cremonese

Document change record

Issue	Revision	Date	Affected Pages	Change description
0	0	07/03/2020	All	Draft
1	0	18/07/2020	All	Final version

1. Introduction

1.1. Scope

The present document has been issued to describe the ICO#3 (Third Instrument Check Out Phase) Tests of STC, channel of the Spectrometers and Imagers for MPO BepiColombo Integrated Observatory SYStem (SIMBIO-SYS).

1.1. Reference Document

[RD. 1]	BC-SIM-TN-003 - Reports and Note Layout and Flow - Version 2 (10.20371/INAF/TechRep/179)
[RD. 2]	BC-SIM-GAF-MA-002 rev.10 SIMBIO-SYS FM User Manual
[RD. 3]	STC FPA Delivery Review Board (DRB) Data Package FM (BC-SIM-RVS-DP-021)
[RD. 4]	Simioni, Emanuele, et al. "SIMBIO-SYS/STC stereo camera calibration: Geometrical distortion." <i>Review of Scientific Instruments</i> 90.4 (2019): 043106. (10.1063/1.5085710)
[RD. 5]	BC-SIM-PL-005 - _SIMBIO-SYS_Checkout_03_Test_Summary_Issue1_Revision0 (10.20371/INAF/TechRep/172)
[RD. 6]	BC-SIM-TR-019 - _STC_ICO#02_report (10.20371/INAF/TechRep/138)
[RD. 7]	BC-SIM-TN-004 - _SIMBIO-SYS_FOP_update_after_NECP (10.20371/INAF/TechRep/58)
[RD. 8]	BC-SIM-TR-24 EGSE ICO3 (10.20371/INAF/TechRep/185)
[RD. 9]	BC-SIM-TR-013 - _STC_ICO#01_report (10.20371/INAF/TechRep/89)
[RD. 10]	BC-SIM-TR-015 SIMBIO-SYS Instrument CheckOut #01 Test Report (10.20371/INAF/TechRep/98)
[RD. 11]	BC-SIM-TR-003 - _STC_NECP_report (10.20371/INAF/TechRep/26)
[RD. 12]	BC-SIM-TR-007 STC Delta-NECP REPORT (10.20371/INAF/TechRep/71)
[RD. 13]	BC-SIM-TR-018 - _HRIC_ICO2 Report (10.20371/INAF/TechRep/100)
[RD. 14]	SIMB_2014-10-13_MIB_Report
[RD. 15]	SICD_Software_Interface_Contral_Document (bc-sim-gaf-ic-002_rev12)
[RD. 16]	BC-SIM-TN-001 The_Flight_Operation_Procedures of the SIMBIO-SYS instrument aboard the BepiColombo ESA_mission (10.20371/INAF/TechRep/15)
[RD. 17]	BC-SIM-TN-002-STC_Observation_Strategy_Issue1_Rev4 (10.20371/INAF/TechRep/35)
[RD. 18]	BC-SIM-TN-009_STC_GM_Observation_Strategy_Optimization_20220706 (10.20371/INAF/TechRep/173)

1.1. Acronyms

ACK	Acknowledgment
ADC	Analogical Digit Converter
APID	Application Process IDentifier
ASW	Application SoftWare
CM	Color Mode
CSV	Comma Separated Values
DSNU	Dark Signal not Uniformity
FOP	Flight Operation Procedure
FPA	Focal Plane Assembly
HK	Housekeeping
HRIC	High spatial Resolution Imaging Channel
ICO	Instrument Checkout
IT	Integration Time
ME	Main Electronics
NECP	Near Earth Commissioning Phase
OBCP	On-Board Control Procedure
OB	Optical Bench
OBSW	On Board Software
ODS	Offset Dark Subtraction
PDOR	Payload Direct Operation Request
PDS	Planetary Data System
PE	Proximity Electronics
PNG	Portable Network Graphics
PSC	Packet Sequence Control
RT	Repetition Time
SIMBIO-SYS	Spectrometers and Imagers for MPO BepiColombo Integrated Observatory SYStem
SSC	Source Sequence Count
SSMM	Solid State Mass Memory
STC	STereo imaging Channel
S/C	Space-Craft
TC	TeleCommand
TEC	Thermo-Electric Cooler
TM	Telemetry
VIHI	VIisible and Hyper-spectral Imaging channel
XML	eXtensible Markup Language

1.2. Document Format and Repository

This document is compliant with the SIMBIO-SYS Report and Note Layout and Flow **[RD. 1]** and will be archived both on the INAF Open Access repository and the SIMBIO-SYS team Archive.

1.3. Document Organization

This document is organized in sections whose topics are listed as follows:

- *Section 2* – Definitions and assumptions
- *Section 3* – ICO2 objective, with a brief description of the test executed reported in details in the following sections.
- *Section 4* – “Functional test” description including commanding and HK interpretation and discussion.
- *Section 5* – “Performance Test” description including commanding and HK interpretation and discussion.
- *Section 6* - “Interference Test” description
- *Section 7* – Description of the test reports in attachment.

2. Definitions and assumptions

In this section the main physical and technical terms are defined.

2.1. STC Sensors

Param.	ID	Param. Name	Packet ID	Packet name	Unit	Calibration
NSS21040	STC	Temperature FPA1	YSS40002	SIMB STC Housekeeping	K	CSSP0020TM
NSS21041	STC	Temperature FPA2	YSS40002	SIMB STC Housekeeping	K	CSSP0021TM
NSS21042	STC	Temperature PE	YSS40002	SIMB STC Housekeeping	K	CSSP0022TM
NSS21043	STC	Temp channel fw	YSS40002	SIMB STC Housekeeping	K	CSSP0023TM
NSS21044	STC	Temp channel bw	YSS40002	SIMB STC Housekeeping	K	CSSP0024TM
NSS21050	STC	PE 3.3V Measured	YSS40002	SIMB STC Housekeeping	V	CSSP0025TM
NSS21051	STC	TEC Current	YSS40002	SIMB STC Housekeeping	A	CSSP0026TM

Table 1 Main temperature sensors of STC on the FPA, PE, the backside of the detector and the STC Optical Bench as Reported in [RD. 2]).

The position of the temperature sensors are shown in Figure 1 (a,b and c) and Figure 2 (a) extracted by

The STC Temperature FPA1 and FPA2 sensors, (often abbreviated TFPA1 and TFPA2 respectively), are located next to the detector surface (see Figure 2). Their temperature readings increase when the detector is switched on, then their values lower when the TEC is switched on to cool the detector; their temperature values are also used as feedback for the TEC.

The Temp Channel-Fw and Temp Channel-Bw were initially located on the optical bench near the folding mirrors of the Forward and Backward channels (defined, in a later stage, Ch-2 and Ch-1 or Channel-High and Channel-Low respectively). The Temp Channel-Fw (defined nowadays as FPA Package) sensor was, at a later time, located on the hot side of the FPA package, thus it is expected to have values corresponding to instrument temperature; the Temp Channel-Bw (defined nowadays STC-Optical Bench) is located on the back of one of the folding mirrors as in Figure 1 (b) gives a measurement of the OB temperature in the front part of the STC Channel-Low and near the VIHI PE, as shown in Figure 1 (c).

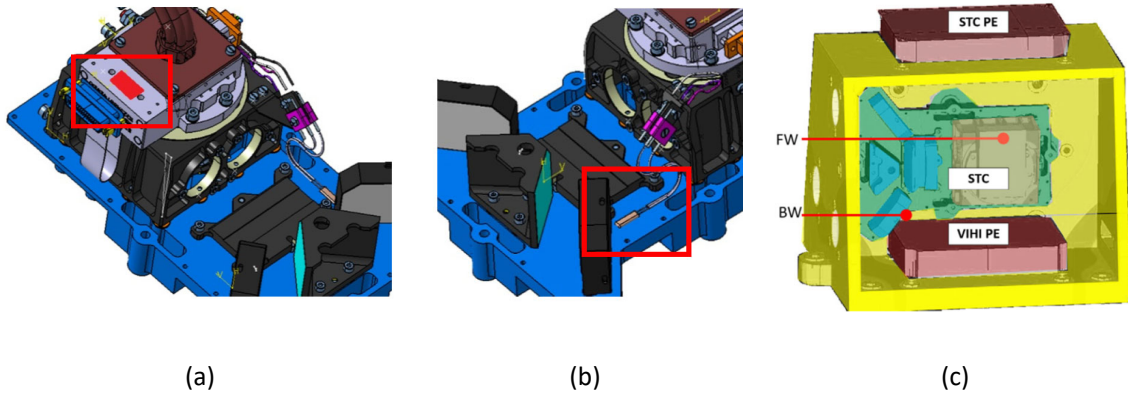

Figure 1 In (a) the location of the “STC Temperature FPA Package (fw)” (NSS21043) temperature sensor (red rectangle). As highlighted in the 3D CAD model (no pictures are available, it is not present in the original CAD model), this sensor is placed onto the FPA package, in the same position where the corresponding sensor is placed on the HRIC FPA. In (b) the location of the “STC Temperature Optical Bench (bw)” (NSS21044) temperature sensor, as shown in the 3D CAD model (no picture available). In (c) the overview of the layout of SIMBIO-SYS showing VIHI and STC PE respect the Temperatures sensors.

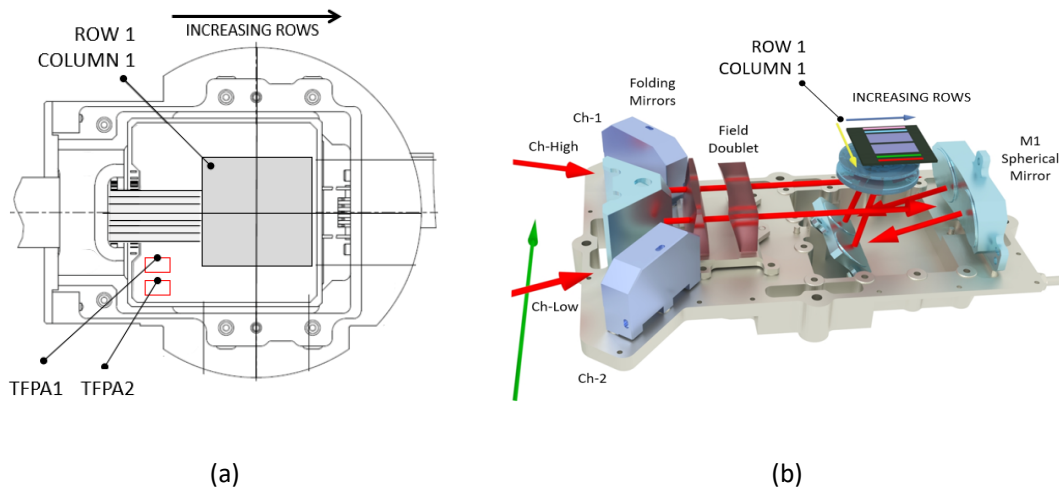

Figure 2 In (a) Location of the “STC-FPA Temperature sensors” next to the FPA (see the red rectangles). They are called TFPA1 (upper one) and TFPA2 (bottom one) and are associated respectively with the NSS21040 and NSS21041 (see [RD. 3]). In (b) STC schematic optical layout where the origin of the detector reference system is indicated. In green an along track direction. In red the optical path. Image shows the correspondence Ch-2 / Channel-Low and Ch1 /Channel High. Complete description of the scheme could be found in [RD. 4].

3. STC-ICO3 Tests

As reported in [RD. 5], the ICO3 SIMBIO-SYS Phase had the scope to verify the health status of the instrument at channel and system level after 18 months after launch. Few functional and performance tests are planned to monitor the evolution of some key instrument parameters.

During this S/C phase, after the Thermal Tests the heating temperate thresholds were changed from [+4 +5]° (threshold used only in the thermal stress phase) to [+5 +6]° as in ICO2 phase to avoid any kind of problem due to STC/HRIC TEC current.

Table 2 reports STC activities more detailed.

Test name	Monitoring	Commanding time
STC Functional Test	PE,TEC, memory, acquisition, capability	2020-176T19:26:30.000
STC Performance Test	DC and DSNU Verification	2020-176T20:08:52.000
STC-HRIC interference test	DC and effect of the two channels possible interference	2020-176T23:26:30.000

Table 2 Table of the Tests as reported in [RD. 5].

3.1. TEC Parameters

As performed in the previous ICO#1 and ICO# 2test ([RD. 6] and [RD. 9]) for details), during the switch on of the ME (before the beginning of the ICO) the STC TEC parameters were updated substituting the default values with the nominal ones ([RD. 2]).

Differently from other uploaded parameters (i.e. VIHI Bias Detector parameters which remain in the PE RAM until the PE is switched off), when the TEC parameters have been uploaded, they are written in the CPCU RAM, so they remain available up to the next SIMBIO-SYS switch off (see **Error! Reference source not found.**] Section 8.3.1.10 and 8.3.1.16).

The summary of the parameters used for STC in the NECP phase and in all the ICOs phases is reported in following table.

Name	Data-kind	Meaning	NECP Phase Nominal	ICO1 Phase	ICO2 ICO3 Phase
NP	[16 bit uint]	Proportional gain	77	128	77
NI	[16 bit uint]	integral gain	33	229	33
N_E	[16 bit uint] (only 12 lsb's may be not zero)	PI operation threshold	112 (10K)	34(3K)	112 (10K)
NSS	[16 bit uint] (only 14 lsb's may be	Soft start Ramp slope	12289	5	12289

	not zero)				
BSS o BSTART	[2 bits]	- bit 15= 0/1 : anti-windup ON/OFF; - bit 14= 0/1 : P-only/ramp soft start	11	11	11
T_REF	[16 bit uint]	Reference FPA commanded temperature (only 12 lsb's may be not zero)	2799 (268 K)	2799 (268 K)	2799 (268 K)

Table 3 TEC Soft-Start parameters

Once the ME was switched on (with the updated parameters) all the functional tests were commanded by a sequence of the FOP SS-TST-020 (see [RD. 7]).

3.2. Heating and Cold Fingers

This section discusses the trend of the STC Cold Finger (CF) temperature sensor named MPO-TEMP-SIMBIO-STC-CF and identified as NRUD2087 (see [RD. 11] for a detailed description of the sensors and their positions).

STC CF temperature trend during ICO3 is shown in Figure 3. For the sake of completeness, we report the trends of the CFs of all the three channels of SIMBIO-SYS. HKs were acquired with a sample rate of 1 minute.

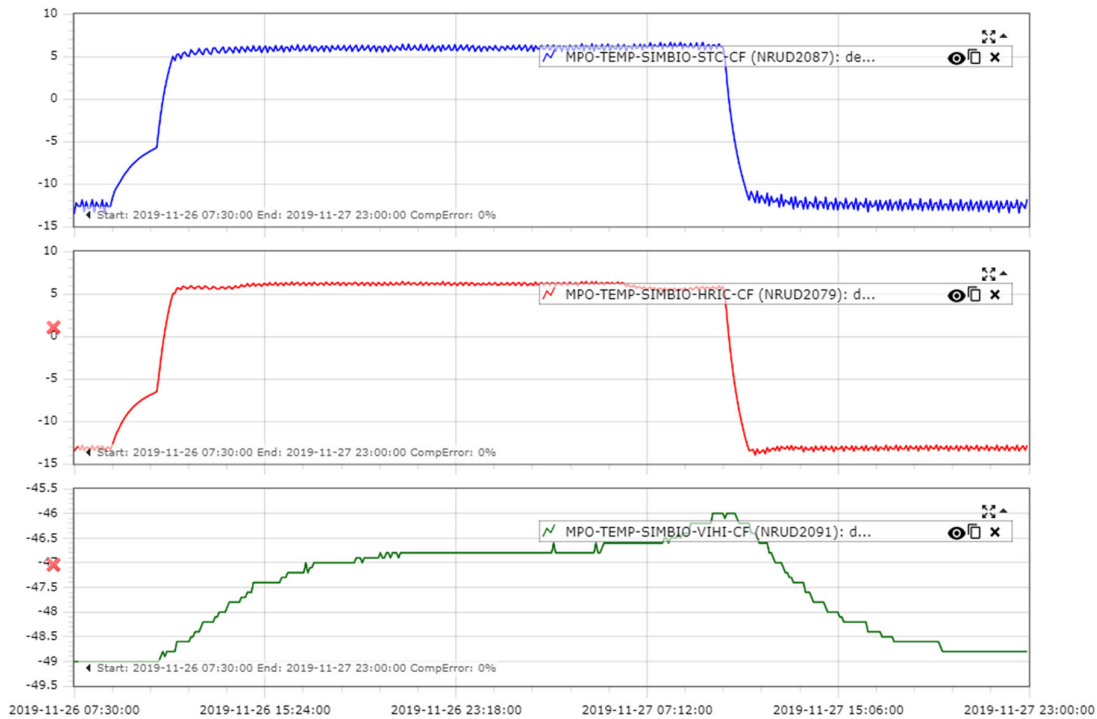

Figure 3 Measurement for STC (blu), HRIC (red) and VIHI (green) Cold Fingers during ICO3 phase (time window is 2019-11-26 07:30:00 / 2019-11-27 23:00:00). Temperature is reported in °C.

The cold fingers have reached the temperature thresholds after 2.4 h of heating. **As required by the team, the temperature range was increased compared to ICO1 (from +4/+5°C to +5/+6 °C) in manner to guarantee (as in ICO2) the nominal gentle activation of the imaging channels TEC.**

This allowed the instrument to avoid the anomalies reported as Issue 1 in **[RD. 10]**.

As shown in *Figure 4* the redundant heater of the imaging channels (NPWD1023) remained switched on for all the duration of the test while the nominal line (NPWD0923) was cyclically switched on and off to maintain the CF in the temperature ranges required by the thermal settings.

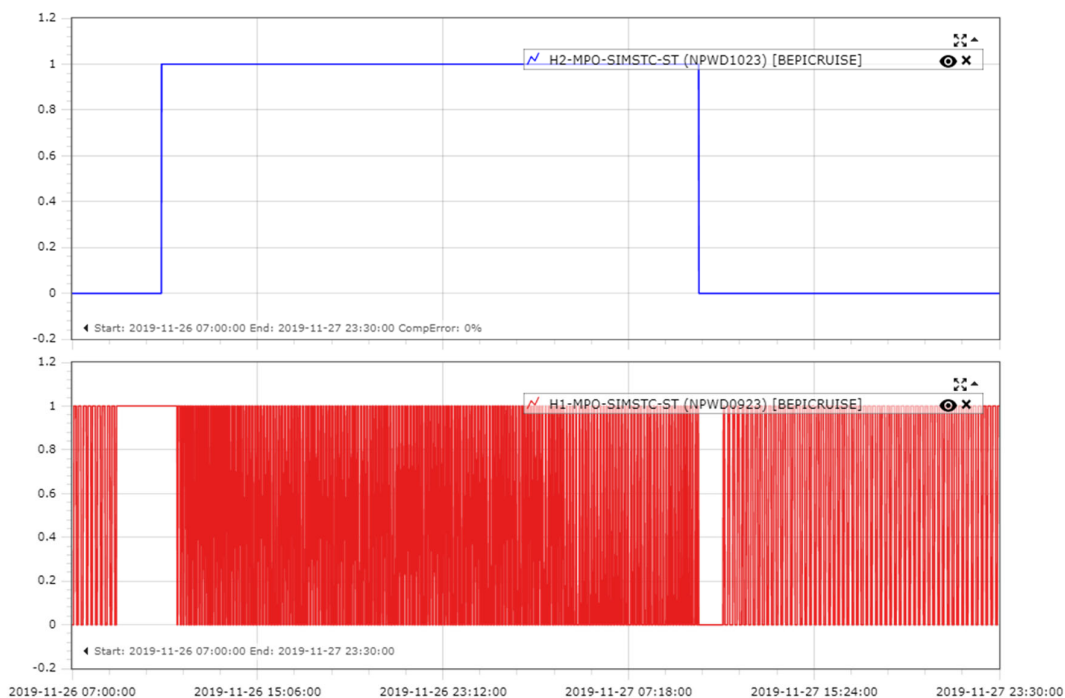

Figure 4 trends of the redundant (upper plot) and nominal (lower plot) swith on /off cycles during ICO3.

The on/off cycles are reported in **Figure 5** which shows, for each epoch of the ICO3 tests, the duration (time between an off-on switch and the following one) of the main heater cycle. The duration has initially measured around 12.5 minutes. During the increasing curve of the, the Heater was always switched on. During the operative phase, the cycle can be considered decreased to 7.5 minutes. After the decreasing curve of the CF (68 minutes) it return to be as initially at 12.5 minutes. The trend respects all the characteristics measured for the other ICO (see Figure 4 of **[RD. 6]** for comparison with ICO1 and ICO2).

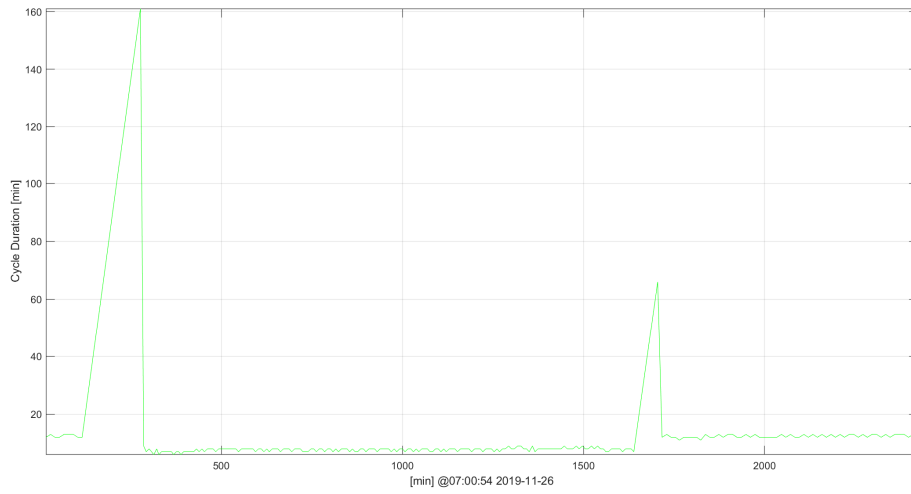

Figure 5 Cycle on-off duration during the ICO3 phase for the main heater (id HK: NPWD0923)

4. STC Functional Test

4.1. Test description

During ICO#03 STC repeated the Functional Test of ICO#2 [RD. 6]. The STC functionality has been verified by means of dedicated Functional Test procedure (TST-020, see [RD. 7]) with the aim of verifying:

- o PE, TEC and detector activation
- o memory/registers status
- o science acquisition capability

The STC functionality will be tested by means of the following TCs sequence:

- PE switch-on
- Detector switch-on
- TEC switch-on (nominal TEC parameters)
- Test of the reading and writing of a specific memory address
- The following science acquisitions:
 - o a ten of GM compressed acquisitions with low RT,
 - o a ten of GM compressed acquisitions with high RT,
 - o a ten of CM compressed acquisitions with low RT,
 - o a ten of CM compressed acquisitions with high RT
- TEC switch-off
- Detector switch-off
- PE switch-off

4.2. Commanding

Once the ME was switched on (with the updated parameters) all the functional test were commanded by a version of FOP SS-TST-020 (updated after NECP phase) whose details and updates can be found in [RD. 7] All science TCs planned were nominally executed. The summary of the TCs and the consequent images dataset generated is reported in **Table 4** and **Table 5**.

Timeline	Relative	TC	Scope	Notes
0:00:00	00:00:00	ZSS00329	Set HK to 1 s	
0:00:05	00:00:05	ZSS17210	Send SIMB STC Detector On/Off	Switch On STC PE (Channel) (to restore after ASW update with TEC initialization).
0:00:10	00:00:05	ZSS17203	Send SIMB STC Thermal Control On/Off	TEC set point: 268K
0:00:15	00:00:05	ZSS17206	Send SIMB STC Read Addr	Read memory present status
0:00:30	00:00:15	ZSS17206	Send SIMB STC Read Addr	
0:00:35	00:00:05	ZSS17207	Send SIMB STC Write Addr	Test Writing Memory
0:00:40	00:00:05	ZSS17204	Send SIMB STC Confirm Command	

0:00:45	00:00:05	ZSS17207	Send SIMB STC Write Addr	Test STC science test pattern
0:00:50	00:00:05	ZSS17204	Send SIMB STC Confirm Command	
0:15:50	00:15:00	ZSS17202	Start STC Science (GM Mean)	
0:16:10	00:00:20	ZSS17202	Start STC Science (GM Max)	
0:18:20	00:02:10	ZSS17202	Start STC Science (CM-Mean)	
0:18:30	00:00:10	ZSS17202	Start STC Science (CM-Max)	
0:18:54	00:00:24	ZSS17209	Send SIMB STC Stop Science	End test.
0:18:59	00:00:05	ZSS00329	Set HK to 10 s	

Table 4 Timeline of the Functional Tests with the references to the commanded ZSS (see [RD. 8] for more details). The table reports the **commanding time** relative and respect the beginning of the procedure. All science acquisition were commanded in continuous.

The resulting database derived by EGSE telemetry to raw pipeline is reported in **Table 5**.

EGSE_NTC [#]	First_Acq [UTC]	Duration [s]	NACQ [#]	DimX [px]	IT [ms]	RT [s]	Windows
1	2020-06-24T19:44:40.088986	18	10	896	0.096	2	GM
2	2020-06-24T19:45:00.088986	123	11	896	1.4976	12.3	GM
3	2020-06-24T19:47:15.388515	4.4	12	896	5.2992	0.4	CM
4	2020-06-24T19:47:20.188518	22.5	12	896	37.7952	2.05	CM

Table 5 Resulting database of the ICO4 Functional Test. All TCs were commanded with the CBD = 64x64 and, nominally, the IBR was set to 32 for the GM and 63 for the CM.

Note that TC4 is supposed (by the looks) to be commanded 10 seconds (see in **Table 4** the four science TCs ZSS17202) after TC3 which means it should produce, without considering delays, 25 acquisitions. **Table 5** highlights a duration of the acquisitions of TC3 of 4.4s corresponding to 12 images.

This is due to a known expected delay in the execution of TC3 which should be executed 00:02:10 after previous one (which means at 19:47:10) but was delayed to 19:47:15 because of the Science on Science mode. In this mode the TC are immediately accepted by ME but their execution is always delayed at the clock of the current RT (in this case 12.3 s)(see [RD. 15] for more details). This issue is applicable only to Science TC which , for STC , are ZSS17202 (SIMB STC SCIENCE), ZSS172B2 (SIMB STC SCIENCE 1ms) and ZSS17209 (SIMB STC Stop Science).

1.1. HKs interpretation and discussion

Nominal parameters updated allowed the “gentle” activation of the STC TEC introducing a graceful cool-down and so avoiding a possible OOL current peak. **Figure 6** shows the current profile of STC TEC current. The shape of the signal is a normal overshoot in the control followed by a nominal gradual ramp.

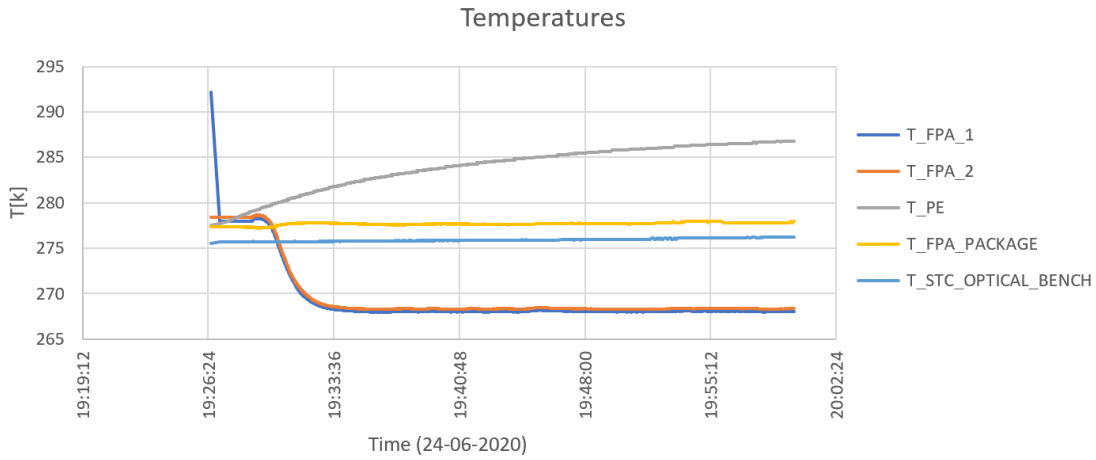

(a)

Tec Current

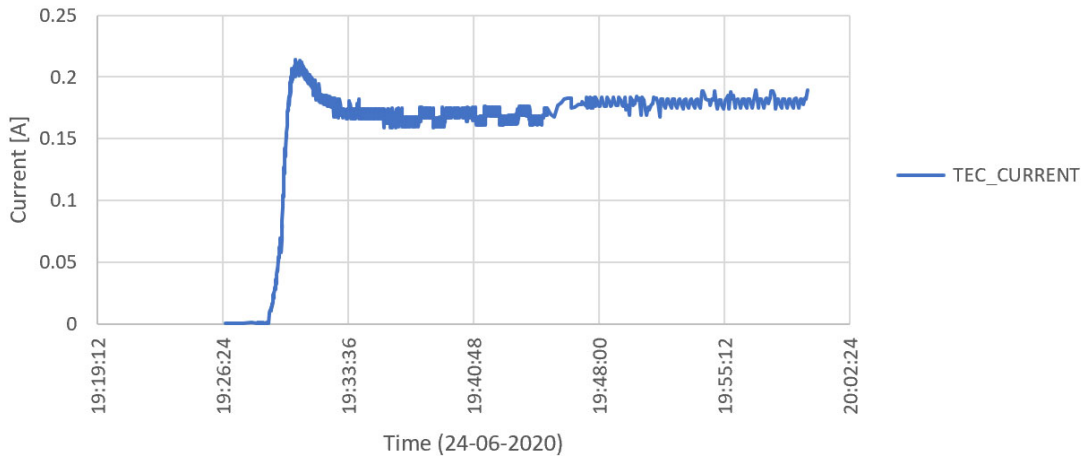

(b)

Figure 6 Temperatures (a) and TEC current values. FW sensor name was replaced with more correct “FPA package” while “Optical bench” replaced BW one (b) evolution over the Functional Tests of ICO1. For HK description details see **Table 1**.

Science data acquired during Functional Tests has no anomalies from an operational point of view.

The main Dark parameters (such as mean and std of the signal) confirm the one acquired during ICO1 (see [RD. 9]) and ICO2 (see [RD. 6]).

A first reduction of the dataset is shown in **Figure 7**. The image shows, for each acquisition, the mean value of the windows included in the 4 TCs. Right y-axis (yellow) reports the distance between each acquisition and the previous one.

As expected for the firsts two TCs (GM) the signal results nominally constant for all the 3 windows considered (WINX+PANH+PANL). In the case of the CM the peak-issue brings to a not constant level of the dark in the case of high times between the acquisitions. The issue will be resolved during the Scientific Phase of the Mission by Offset Dark Subtraction (ODS) (see [RD. 6]) which is based on the offset measured by averaging the dark present on the win-x, guaranteeing to have a correct measurement of the dark both at the beginning or at the end of the acquisition sequences.

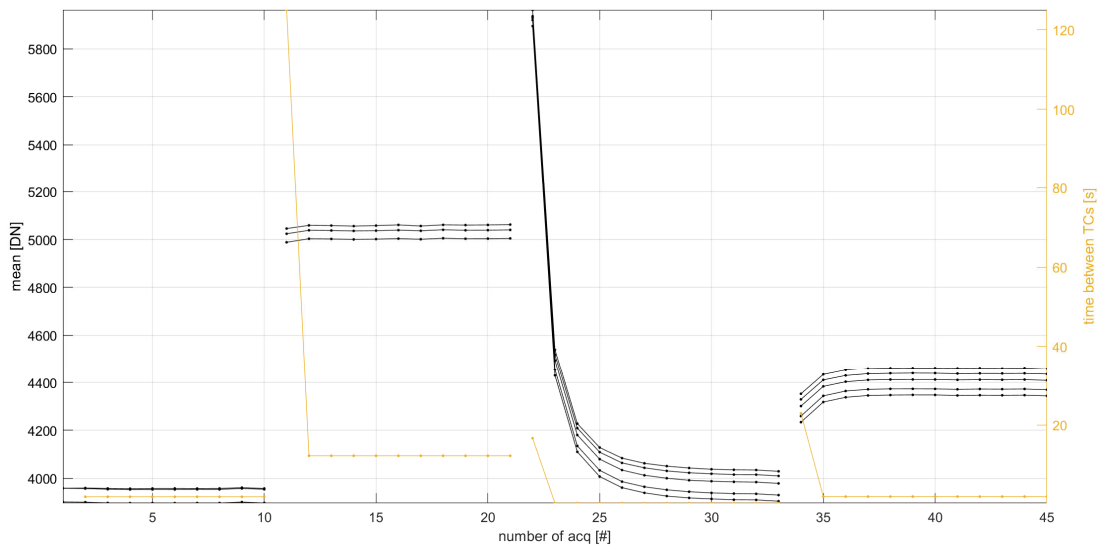

Figure 7 The figure reports the reduction in mean of the images of the Functional tests. Right y-axis (yellow) report the distance between each acquisition and the previous one.

Inverse peak of the 2 set of images of the CM needs more investigations but confirm the behaviour measured at the first and second check out (see [RD. 9] and [RD. 6]).

5. STC Performance Test

5.1. Test description

During ICO#03 the STC performance has been verified by means of minimal Performance test procedures with the aim of verifying of DC behavior for the nominal IT and Repetition Time (RT). Same IT and RT were commanded during NECP (see [RD. 11]) and ICO1 (see [RD. 9]) and ICO2 (see [RD. 6]).

5.2. Commanding

This test has been performed through the execution of 1 pre-defined PORs named:

- “POR511_STC”

See [RD. 5] for more details.

The POR performed 5 tests:

- 3 GM dark sets of acquisitions (with 2 RTs),
- 1 CM dark set of acquisition
- 1 WinX set continuing the analysis started in ICO1 performance tests.

These assumptions divide the POR in five phases (see the timeline in Table 6.). Each phase commands the integration of 21 different ITs in manner to obtain for the dark curves for the low and high repetition times defined.

EGSE NTCs	Fop Names	Mode	NTCs [#]	Min IT [ms]	Max It [ms]	RT [s]
* 1-21	ASSF307/317	GM	21	0	9600	14
22-42	ASSF307/317	GM	21	0	9600	Where possible 7
43-63	ASSF307/317	GM	21	0	9600	Where possible 0.8
64-84	ASSF308/318	CM	21	0	9580	Where possible 5
85-105	ASSF300/310	WX	21	0	9600	Where possible 0.45

Table 6 Timeline of the 4 phases TCs of the PERFORMANCE TEST with the references to the commanded FOPs (see [RD. 7] for more details). All phases commands 21 TCs with different ITs. In the same phase the RT commanded is constant a part for the stellar integration times (FOP-317 and 318). Table reports with (*) the phases not executed (first one).

After the VSSs update which guarantees the possibility of setting a RT greater than 2460 RAW (12.3s) (the ESOC upper limit was increased to 4000) part of the performance test were commanded with a RT of 2800 (14s). This was a manner to test DC for the RT defined for mercury high latitudes in manner to limit the Data Volume and guarantee the overlapping between along track image. This high RT was foreseen by see Operation Strategy Table 9 ([RD. 17]) or Observation Strategy Optimization, Figure 7 ([RD. 18]) but this PSS high value was never commanded during previous test.

The first 21 TCs (the ones with RT=2800 (14s)) were rejected by ASW for a OOL (not taken in account by operation team) of the RT.

This limit is reported (pag 186) in [RD. 15] and it will be updated in the next ASW release. The resulting database derived by EGSE telemetry (see [RD. 8]) to raw pipeline is reported in Table 7.

EGSE_NTC	First_Acq	Duration	NACQ	IT	RT	IBR	Windows
[#]	[UTC]	[s]	[#]	[ms]	[s]	[#]	
22	2020-06-24T20:56:12.088081Z	28	5	0	7	0	GM
23	2020-06-24T20:57:24.087913Z	28	5	0.0096	7	0	GM
24	2020-06-24T20:58:36.087698Z	28	5	0.0576	7	0	GM
25	2020-06-24T20:59:48.087515Z	28	5	0.1056	7	0	GM
26	2020-06-24T21:01:00.087423Z	28	5	0.192	7	0	GM
27	2020-06-24T21:02:12.087315Z	28	5	0.288	7	0	GM
28	2020-06-24T21:03:24.087132Z	28	5	0.336	7	0	GM
29	2020-06-24T21:04:36.086963Z	28	5	0.48	7	0	GM
30	2020-06-24T21:05:48.086734Z	28	5	0.576	7	0	GM
31	2020-06-24T21:07:00.086718Z	28	5	0.96	7	0	GM
32	2020-06-24T21:08:12.086427Z	28	5	2.4	7	0	GM
33	2020-06-24T21:09:24.086305Z	28	5	3.36	7	0	GM
34	2020-06-24T21:10:36.086213Z	28	5	4.8	7	0	GM
35	2020-06-24T21:11:48.085998Z	28	5	9.6	7	0	GM
36	2020-06-24T21:13:00.085830Z	28	5	30	7	0	GM
37	2020-06-24T21:14:12.085753Z	28	5	150	7	0	GM
38	2020-06-24T21:15:24.085661Z	28	5	270	7	0	GM
39	2020-06-24T21:16:36.085538Z	28	5	480	7	0	GM
40	2020-06-24T21:17:48.085370Z	28	5	960	7	0	GM
41	2020-06-24T21:19:00.085110Z	28	5	4800	7	0	GM
42	2020-06-24T21:20:12.085063Z	39.6	5	9600	9.9	0	GM
43	2020-06-24T21:21:53.084773Z	7.2	10	0	0.8	1	GM
44	2020-06-24T21:22:03.084864Z	7.2	10	0.0192	0.8	1	GM
45	2020-06-24T21:22:13.084772Z	7.2	10	0.384	0.8	1	GM
46	2020-06-24T21:22:23.084834Z	7.2	10	0.768	0.8	1	GM
47	2020-06-24T21:22:33.084650Z	7.2	10	1.92	0.8	1	GM
48	2020-06-24T21:22:43.084772Z	7.2	10	2.88	0.8	1	GM
49	2020-06-24T21:22:53.084726Z	7.2	10	3.36	0.8	1	GM
50	2020-06-24T21:23:03.084681Z	7.2	10	3.84	0.8	1	GM
51	2020-06-24T21:23:13.084711Z	7.2	10	4.8	0.8	1	GM
52	2020-06-24T21:23:23.084650Z	7.2	10	5.28	0.8	1	GM
53	2020-06-24T21:23:33.084680Z	7.2	10	7.2	0.8	1	GM
54	2020-06-24T21:23:43.084589Z	7.2	10	9.6	0.8	1	GM
55	2020-06-24T21:23:53.084573Z	7.2	10	12.48	0.8	1	GM
56	2020-06-24T21:24:03.084497Z	7.2	10	20.16	0.8	1	GM

57	2020-06-24T21:24:13.084634Z	7.2	10	45.2256	0.8	1	GM
58	2020-06-24T21:24:23.084466Z	7.2	10	150	0.8	1	GM
59	2020-06-24T21:24:33.084497Z	7.2	10	270	0.8	1	GM
60	2020-06-24T21:24:43.084436Z	7.2	10	480	0.8	0	GM
61	2020-06-24T21:24:53.084435Z	11.3	10	960	1.26	0	GM
62	2020-06-24T21:25:08.084405Z	45.9	10	4800	5.1	0	GM
63	2020-06-24T21:26:01.084237Z	89.1	10	9600	9.9	0	GM
64	2020-06-24T21:27:42.084037Z	45	10	0	5	1	CM
65	2020-06-24T21:28:34.083930Z	45	10	0.0192	5	1	CM
66	2020-06-24T21:29:26.083915Z	45	10	0.384	5	1	CM
67	2020-06-24T21:30:18.083731Z	45	10	0.768	5	1	CM
68	2020-06-24T21:31:10.083654Z	45	10	1.92	5	1	CM
69	2020-06-24T21:32:02.083532Z	45	10	2.88	5	1	CM
70	2020-06-24T21:32:54.083424Z	45	10	3.36	5	1	CM
71	2020-06-24T21:33:46.088429Z	45	10	3.84	5	1	CM
72	2020-06-24T21:34:38.088261Z	45	10	4.8	5	1	CM
73	2020-06-24T21:35:30.088092Z	45	10	5.28	5	1	CM
74	2020-06-24T21:36:22.088153Z	45	10	7.2	5	1	CM
75	2020-06-24T21:37:14.087969Z	45	10	9.6	5	1	CM
76	2020-06-24T21:38:06.087832Z	45	10	12.48	5	1	CM
77	2020-06-24T21:38:58.087770Z	45	10	20.16	5	1	CM
78	2020-06-24T21:39:50.087587Z	45	10	45.2256	5	1	CM
79	2020-06-24T21:40:42.087602Z	45	10	150	5	1	CM
80	2020-06-24T21:41:34.087388Z	45	10	270	5	1	CM
81	2020-06-24T21:42:26.087280Z	45	10	480	5	0	F750+x
82	2020-06-24T21:43:18.087204Z	45	10	960	5	0	F750+x
83	2020-06-24T21:44:10.087081Z	45	10	4800	5	0	F750+x
84	2020-06-24T21:45:02.086943Z	89.1	10	9580.8	9.9	0	F750+x
85	2020-06-24T21:46:43.086836Z	1.8	5	0	0.45	0	WINX
86	2020-06-24T21:46:48.086759Z	1.8	5	0.0096	0.45	0	WINX
87	2020-06-24T21:46:53.086790Z	1.8	5	0.0576	0.45	0	WINX
88	2020-06-24T21:46:58.086790Z	1.8	5	0.1056	0.45	0	WINX
89	2020-06-24T21:47:03.086774Z	1.8	5	0.192	0.45	0	WINX
90	2020-06-24T21:47:08.086759Z	1.8	5	0.288	0.45	0	WINX
91	2020-06-24T21:47:13.086683Z	1.8	5	0.336	0.45	0	WINX
92	2020-06-24T21:47:18.086790Z	1.8	5	0.48	0.45	0	WINX
93	2020-06-24T21:47:23.086652Z	1.8	5	0.576	0.45	0	WINX
94	2020-06-24T21:47:28.086744Z	1.8	5	0.96	0.45	0	WINX
95	2020-06-24T21:47:33.086606Z	1.8	5	2.4	0.45	0	WINX
96	2020-06-24T21:47:38.086774Z	1.8	5	3.36	0.45	0	WINX
97	2020-06-24T21:47:43.086744Z	1.8	5	4.8	0.45	0	WINX
98	2020-06-24T21:47:48.086683Z	1.8	5	9.6	0.45	0	WINX
99	2020-06-24T21:47:53.086652Z	1.8	5	30	0.45	0	WINX

100	2020-06-24T21:47:58.086591Z	1.8	5	150	0.45	0	WINX
101	2020-06-24T21:48:03.086637Z	1.8	5	270	0.45	0	WINX
102	2020-06-24T21:48:08.086545Z	3.12	5	480	0.78	1	WINX
103	2020-06-24T21:48:14.086713Z	5.04	5	960	1.26	1	WINX
104	2020-06-24T21:48:23.086545Z	20.4	5	4800	5.1	1	WINX
105	2020-06-24T21:48:51.086529Z	39.6	5	9600	9.9	1	WINX

Table 7 Database derived by EGSE. All TCs commanded CBD=64x64, window dimension along track is 128 for winx acquisitions and 896 in all the other cases .

5.3. HKs interpretation and discussion

Figure 8 shows the trends of the main temperature and current housekeeping (**Table 1**) of STC. The performance test was executed after the functional test starting from a Stand-By mode of the instrument. No switch other on/off were executed during this test.

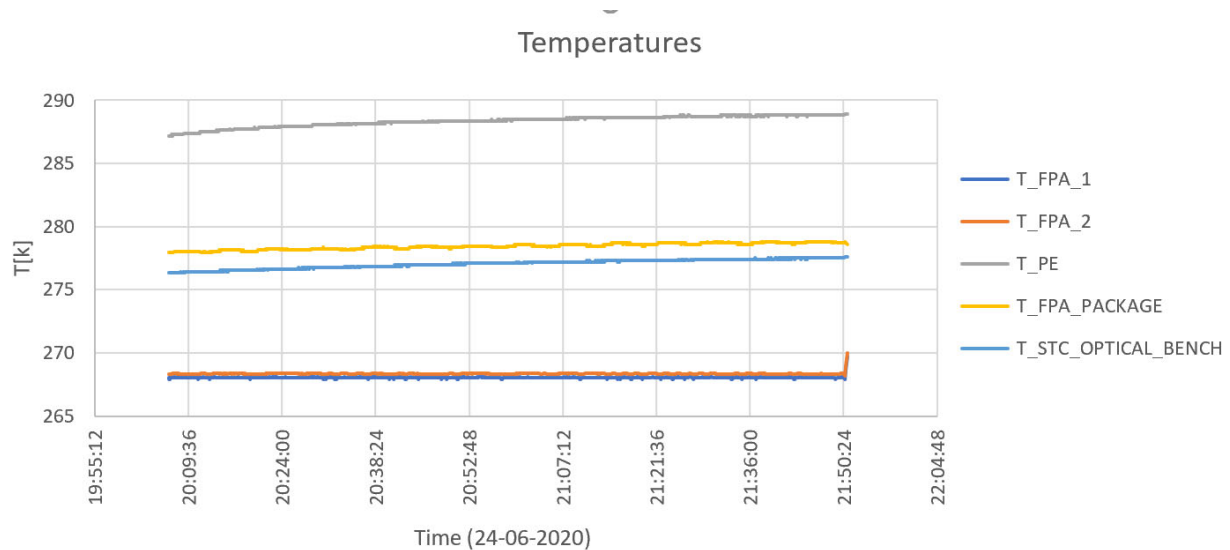

(a)

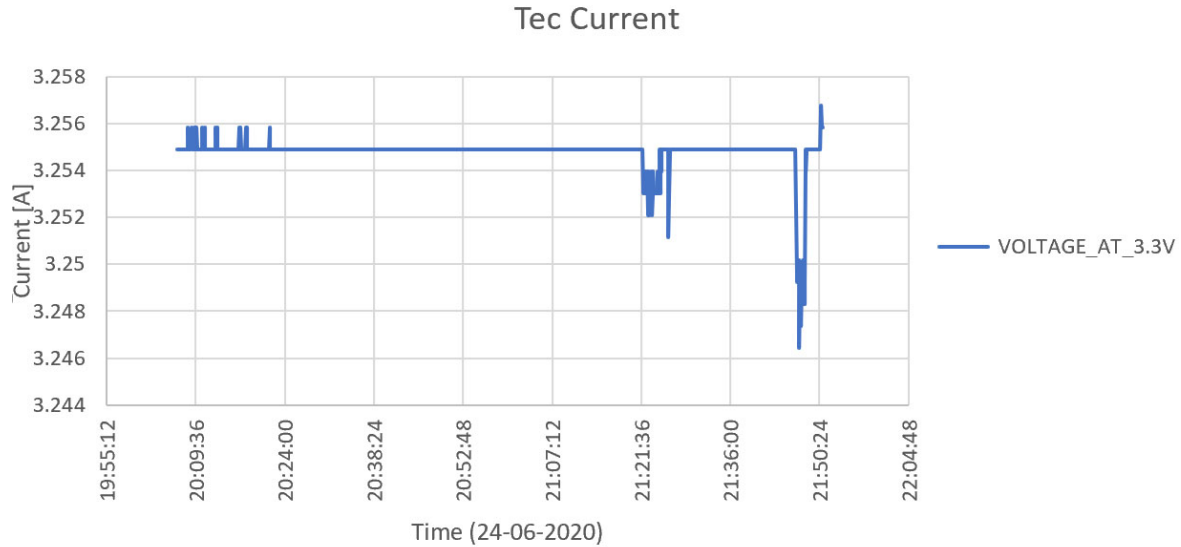

(b)

Figure 8 Temperatures and TEC current values evolution over the Performance Tests of ICO1.

The Science data acquired during Performance Tests has no anomalies from an operational point of view.

A first reduction of the dataset is shown in **Figure 9**. The images show for each acquisition the mean value of the windows included in the 4 TCs. Right y-axis (yellow) report the distance between each acquisition and the previous one.

The figure shows even the exponential models estimated for each set of acquisition. Each signal trend can be modelled by solving nonlinear least-squares curve fitting based on code described in [RD. 9] following the equation:

$$s(n_{acq}) = A - B e^{-\frac{\tau}{n_{acq}}}$$

Where:

- s is the mean signal on the considered window.
- n_{acq} is the number of the consecutive acquisition.
- $A \geq 0$ is the peak value in DN.
- $\tau > 0$ is the velocity term.
- $B \geq 0$ define the stabilization value to be considered as $A - B$.

The model guarantees a mean std of the residuals of 6.8 DN which reach the worst value of 24 DN in the case of maximal integration time commanded. The values are both in the limit of the RON.

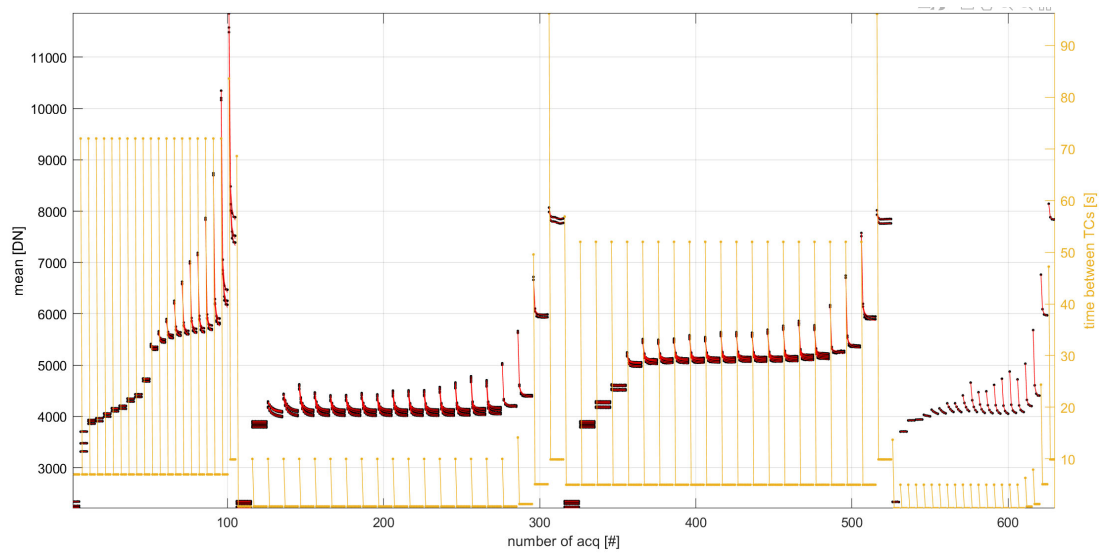

Figure 9 The figure reports the reduction in mean of the images of the Performance tests for the GM. Red lines represent the exponential curves which model by nonlinear fit each set of acquisition. Right y-axis (yellow) report the distance between each acquisition and the previous one.

As result of the exponential model it is possible to define the Dark Current for the low and high repetition times commanded. Tests will be executed for each ICO in manner to measure the stability of the curves.

6. STC-HRIC Interference test

6.1. Test description

The aim of the test is the monitoring of dark low frequency behaviour (see **[RD. 6]** for STC and **[RD. 13]** for HRIC channel) and the impact of the synchronic use of the HRIC channel on this effect. Previous analysis showed a carrier wave with an amplitude of 6DN and a period of 3 minutes on the mean signal of the STC and HRIC acquisitions.

This phenomenon, measured for STC during the Orbit test (see **[RD. 6]**) was not clear if it was in phase or not with HRIC one.

For this reason, this test provided a STC acquisition with fixed IT and RT and a acquisition (with same RT) of HRIC. The two acquisitions were overlapped for 5 minutes.

For more detail see following dedicated Technical Report.

7. Attached documents

In this section the attached documents are enumerated with corresponding links. The Documents represent two kinds of reports: the former traces the HKs and the main fast reduction of all the acquisitions (Performance Report). The latter indicates the Timing Issue linked to the SC and ME delays to each TCs. It covers the time between 2020-06-24T19:44:40.08 (first TC of the ICO3 phase) and 2020-06-25T00:01:28.09 (last acquisition of the ICO3 phase). Fast reading tables are reported in Annex section. For more details a deeper description is reported in next sessions.





Section	Name Report	Link
4	20220718ICO3STC_Functional_Test_STC.xls	
5-6	20191127ICO3STC_Performance_STC	
7	20220718ICO3STC__STC-HRIC_Interference_Test.xls	
7	20220718ICO3HRIC__STC-HRIC_Interference_Test.xls	

Table 8 Performance report file attachment covering the ICO3 phase. We include the analysis of HRIC data during the Interference test for the sake of the completeness.

Name Report	Link
20220718_TimingReport_NECP2ICO3.xlsx	

Table 9 Timing Report file attachment covering the period science NECP PHASE to current one (ICO3). The Log file is divided in sheets as EGSE structure in four different folder representing the different test.

7.1. Performance Report

From the xml files, which include the HKs data, a series of useful quantities have been extracted. The report attached to Table 8 (see Attached Documents Section) includes all the following parameter for each acquisition:

Column	Name	Description
A	ACQ NUM	Number of the acquisition science the first on of the test
B	TC	ID of the TC corresponding to the folder in SIMBIO server (i.e. science001)

C	last_image	Boolean flag defining if the acquisition is or not the last of the TC considered.
D	start_obs	UTC time of the acquisition
E-J	name_WX	Names of the windows acquired as reported in the xml files.
K	start_obs_et_[s]	UTC time of the in seconds
L	IT_[s]	Integration time of the WIN1 acquisition as reported in xml files. It correspond to the Integration time (IT) for each image acquired for a specific telecommand
M	RT_mean_[s]	Repetition time evaluated as the mean time between the first and last acquisition of the TC. In case of 1 acquisition it is not evaluated.
N	WT_[s]	Waiting Time of an acquisition. Derived by the time distance since and the previous acquisition (even if associate to another TC).
O-S	TXXXX_[K]	Temperature HKs (FPA1, FPA2, Channel1, Channel2 and PE temperature) as reported in the xml file
T-AK	mean_Wx_[DN]	For each window acquired is reported the mean of the windows in DN.
	mean64_Wx_[DN]	For each window acquired is reported the mean of the last 64 column of the window in DN.
	DSNU_Wx	For each window acquired is the standard deviation (Dark Signal Non Uniformity (DSNU)) of the window in DN.

Table 10 Columns description of the Performance Report file

7.2. TIMING LOG Report

This report (in attachment at Table 9) allows to check the delay time between the commanded timeline and the executed one due to granularity of the TC at satellite level and to the management of the TC by SIMBIO-SYS ME.

The report is based on the crossing of two documents:

- STACK report: xml file provided by ESOC
- LOGEVENT: provided by EGSE reporting the acceptance and execution time by SIMBIO-ME.

The report includes information extracted by the two documents described in previous section. Columns name, descriptions and sources are reported in next table.

Name	Description	Source
NAME_LOG_EVENT	Name of the LogEvent file	LOGEVENT
NAME_STACK_XML	Name of the ESOC STACK file	STACK
EVENTLOG_SEQ_NUMBER	Event sequence number associate to the ZSS an reported in the EventLog as described in previous paragraphs.	LOGEVENT
STACK_ROW	Row of the STACK file	STACK
FOP	FOP corresponding to the Sequence Name in the Stack file (see previous paragraphs).	STACK
ZSS	FOP corresponding to the Command Name in the Stack file (see previous paragraphs).	STACK
NOTES	Description of the ZSS (see previous paragraphs)	LOGEVENT
CHANNEL	Channel identify the Channel of the TC which means H for HRIC,S for STC,V for VIHI and M for the ME	
ISSCIENCE	Boolean flag true for the 6 TCs of SCIENCE and false everywhere else. Science TCs for the three channels are:	

	ZSS17102, ZSS171B2 (for HRIC), ZSS17202, ZSS172B2 (for STC) ZSS17302, ZSS173B2 (for VIH).	
ACCEPTED_TIME_LOGEVENT	Acceptance time by ME (see previous paragraphs).	LOGEVENT
FAILURE_TIME	Failure time (where happens) by ME (see previous paragraphs).	LOGEVENT
EXECUTED_TIME_LOGEVENT	Execution time by ME (see previous paragraphs).	LOGEVENT
EXECUTED_TIME_STACK	Execution time by satellite. It should correspond to ACCEPTED_TIME_LOGEVENT	STACK
ACCEPTED/ EXECUTED/ FAILED	Boolean report of the result of the execution	LOGEVENT
DELAY_IN_EXECUTION_s	Delay in time execution (in seconds) due to ME issues.	LOGEVENT
DELAY_IN_FAILURE_s	Delay in failure (in seconds where happens) due to ME issues.	LOGEVENT
RT_SEC	Where the FOP is a Science TC. Repetition Time commanded is here reported.	STACK
PSSDESCXXX/ PSSVALSXXX	For each PSS are reported the Description (including PSS id) and the value commanded	STACK

Table 11 Table reports names, description and source of all the columns of the TimingLog file.